



OS Doors[®]

Product Guide 2024

**UK & Ireland's Leading Manufacturer of
Cabinet Frontals and Components**

Introducing New 5G Vinyl Grooved Door Styles **Available Now**

With an ongoing trend for grooved door styles, we have expanded our range by adding 5 new grooved door styles to the 5G collection. Introducing Lena, Mila, Aria, Ella and Olivia. For more information see page 30.



Available in over 90 Finishes
Woodgrain Effects, Legno, Matt Smooth and Superior Matt.

Contents

INTRODUCTION

4	Introduction
6	Ordering Guide
8	Marketing
10	Customer Services
11	Logistics
234	Door Matrix
238	Order Forms
242	Terms and Conditions

5G VINYL

14	5G User Guide
16	5G Modern Door Styles
18	5G Handleless Door Styles
20	5G Plain Shaker Door Styles
22	5G Lined Shaker Door Styles
24	5G Mock In-Frame Door Styles
26	5G Raised Panel Door Styles
28	5G Arched Door Styles
30	5G Grooved Door Styles
33	5G Finishes
36	5G Door Sizes
44	5G Accessories
46	Moulding Specifications
52	Board Match Specifications

5PIECE

56	Harlem Range
62	Dylan Range
68	Fenwick Range
76	Bastille Range

EDGED

92	Phoenix Range (Gloss Acrylic)
98	Tribeca Range (Superior Matt)
104	Vaasa Range (MFC)
110	Mather Range (Legno MFC)

MDF PAINTED

118	Arena Range
124	Parker Range
130	Hartford Range
138	Wellington Range
146	Belair Range
154	Gladstone Range

TIMBER PAINTED

164	Campbell Range
170	Rainey Range
176	Edison Range
182	Monroe Range
188	Albany Range
194	Hampton Range
200	Greenwich Ash Range
206	Greenwich Oak Range
212	Hyde Range
222	Moulding Specifications

HANDLES

228	Standard Handles
232	Integrated Handles

NEW RANGES



We've introduced 6 new door styles into our 5G Vinyl Collection. See page 21 and page 30.

NEW FINISHES



We've introduced new finishes into our 5G Vinyl Range, complete with over 90 finishes to choose from. See page 33.

NEW HANDLES



Explore our new range of Handles and Knobs, available in Chrome, Black, Brushed Nickel, Bronze and Satin Brass. See page 228.

Design that's **Flexible** Delivery that's **Fast** Service that's **First Class**

As the UK and Ireland's leading manufacturer of Kitchen, Bedroom and Bathroom cabinet door frontals, our aim is to deliver your order in full, on time, every time. We work together with you to create flexible manufacturing solutions that satisfy your business needs. Our experience, design expertise and purpose built 410,000 sq ft production facility means that we can successfully fulfill complex requests of any size. With over 6000 Door Styles and Finish combinations to choose from, both Ex.Stock and Made to Measure sizes are all manufactured within the shortest KBB industry lead times. We are a flexible manufacturing partner that will go above and beyond for your business.

Quality Assured — We respect both our natural and working environments. That's why our approach to door production relies on intelligent manufacturing, safe work practices, quality control and e-economic use of materials. We're dedicated to minimising waste and protecting our people. Our facility is ISO 45001, ISO 14001 and ISO 9001 certified, proving our dedication to health and safety, environmental sustainability and quality control. We hold certification from both the FSC® and the PEFC to ensure that our product is made of FSC® -certified and other controlled materials. Only the products that are identified as such on this document are FSC® certified. We are also members of FIRA, an independent body set up to ensure the quality of furniture products.

Sustainability — In 2022 we won the title of Sustainable Supplier of the Year at the Irish Kitchen Trade Awards. Here at O&S Doors Ltd, we are committed to maintaining our all encompassing eco policy. We have a zero waste to landfill policy which means that all our cardboard, plastics, foils and general waste are recycled. Our Environmental Officer and HSEQ Manager work together with company directors to ensure that our environmental standards are being maintained and to ensure that we are making steps in the right direction for the future of sustainable manufacturing.





**Shortest Industry
Lead Times**

With Ex.Stock items ready for same day despatch, and MTM ready from as little as 5 working days.



Ordering Simplicity

Online Ordering — Our custom designed, simple and secure online ordering service allows you to order directly and independently at anytime. You'll be in control, gaining access to inventory status, account management and orders with trade pricing and terms. Save both time and money, creating quick quotes, and placing orders with instant order confirmation. **Order Online at weborders.osdoors.com**

We advise for all the orders to be placed using the online portal, however if you need help or for any special requests please use the relevant email address as listed below:

Northern Ireland - Orders@osdoors.com
Republic of Ireland - Orders@osdoors.com
United Kingdom - OrdersUK@osdoors.com
Express - OrdersExpress@osdoors.com
Manchester - Manchester@osdoors.com

*Please ensure emailed order enquiries are sent to the relevant listed address to avoid disappointment.

Important: Please include your 'Customer Account Number' when ordering to avoid any delays. Please ensure that all details are correct at time of ordering, as we are unable to guarantee that any amendments or cancellations will be possible. Once an order has been processed into our production system no amendments can be made. Items ordered incorrectly are non-refundable. O&S Doors Ltd cannot accept responsibility for any orders that cannot be altered after they have been placed.

New Customers: If you do not have an account with O&S Doors Ltd please email our customer services team using the relevant email address as listed below:

New Customer Enquiries UK - helloUK@osdoors.com
New Customer Enquiries Express - helloExpress@osdoors.com
New Customer Enquiries NI - helloNI@osdoors.com
New Customer Enquiries ROI - helloROI@osdoors.com
New Customer Enquiries Manchester - Manchester@osdoors.com

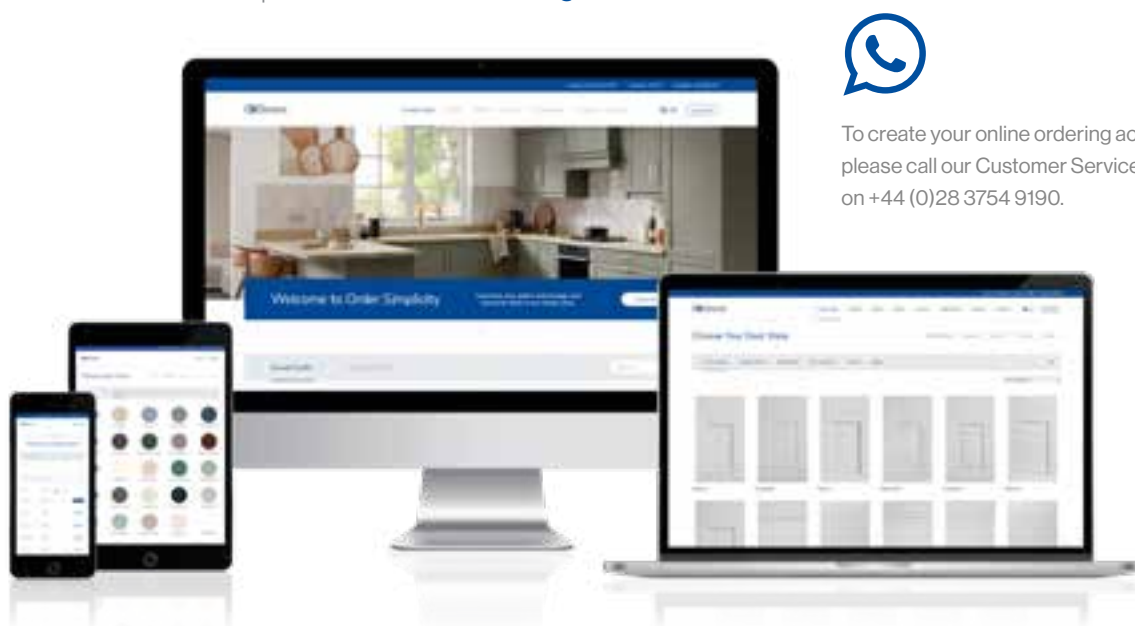

To create your online ordering account please call our Customer Service team on +44 (0)28 3754 9190.

- Easy to use platform
- Instant order confirmation
- Mobile friendly website
- Live pricing for speedy quotes
- Click and collect service available
- Access to extensive product range

Important Notes

Changes to Orders — You will receive an order acknowledgment via email once your order is registered on our system. It is crucial that you notify our Customer Service team of any discrepancies upon receipt of your order acknowledgement. Once an order has been processed on our system no amendments can be made.

Shortages / Damages — Any damages or discrepancies must be reported to Customer Services within 48 hours of delivery. O&S Doors Ltd do not accept any liability for any issues raised after this time.

Replacements — Replacement items must be ordered via email.

UK - aftersalesuk@osdoors.com

ROI & NI - aftersales@osdoors.com

OS Express - ordersexpress@osdoors.com

All customers must fill out our customer service issues form, which you can request from your sales representative or a member of our customer service team. This form should include full details of the damage / discrepancies which must be provided along with clear images and the related O&S Doors Ltd delivery order number. Replacements will be despatched on the next available delivery date, and the original goods will either be retained or returned for inspection.

Warranty (6 Year Limited Warranty) — The warranty period of 6 years for all Replacement and FOC goods commences from the original invoiced date of supply. If you need to make a warranty claim please email your order details to warranty@osdoors.com.

Payment Terms — Unless credit facilities have been agreed in writing, all orders must be paid for in full prior to production. Accounts not operating in line with the agreed credit terms will be closed and outstanding orders will be held until all balances are cleared. O&S Doors Ltd reserve the right to revoke (at any time) any credit terms offered and return to a strictly proforma invoice basis.



Explore Our Core Product Collection

We provide a range of consumer brochures that are designed to inspire you to create magnificent cabinetry. We have a brochure for each of our 4 main product ranges: 5G Vinyl, 5Piece, Painted and Edged.



Marketing Materials



Design Library — When you partner with us, you get exclusive access to our Design Library, complete with high resolution Kitchen and Bedroom CGI Images, Product Imagery, Product Brochures, Technical Specifications and Colour Swatch Guide PDFs.

For access email marketing@osdoors.com

Door Samples — Door samples are available across all of our product ranges in order to help you illustrate the design and quality to your customers.

Door samples are 570mm x 396mm.

Order door samples via orders@osdoors.com
ordersuk@osdoors.com
ordersexpress@osdoors.com
Manchester@osdoors.com

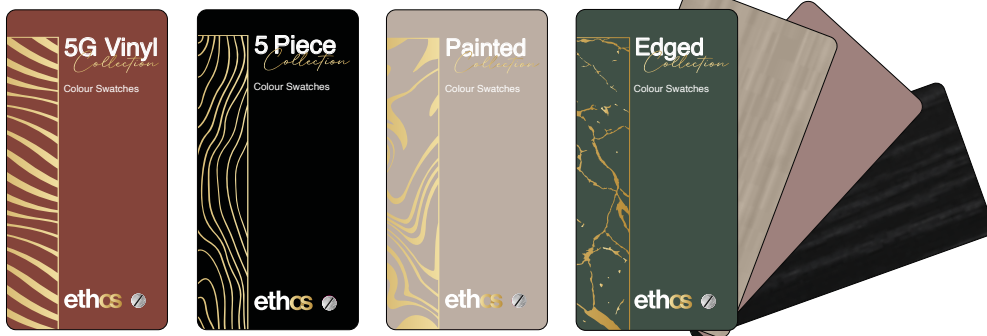

Colour Swatch Books — To get a real sense for the quality of the finish and to ensure that your customer gets the exact colour that they want, we recommend using our Colour Swatch Books. We have individual Colour Swatch Books available for each of our main product ranges: 5G Vinyl, 5Piece, Painted or Edged.

Order Colour Swatch Books via: orders@osdoors.com
ordersuk@osdoors.com
ordersexpress@osdoors.com
Manchester@osdoors.com

Customer Services

We have dedicated Account Managers to provide you with expert advice and insight on all of our services. Each dedicated Account Manager is supported by a member of our Customer Services team to ensure your ordering experience is as straightforward as possible. This approach means you will always speak to the right person, avoiding any delays and allowing your project to run smoothly.

O&S Doors Head Office - Northern Ireland

Reception
+44 (0) 28 3754 9190
info@osdoors.com

Antrim, Armagh, Cavan, Derry/ Londonderry, Donegal, Down, Fermanagh & Tyrone

Helen MacNeice
+44 (0) 28 3754 9190
hmcneice@osdoors.com

Cavan, Clare, Cork, Dublin, Galway, Sligo, Kerry, Laois, Leitrim, Limerick, Longford, Mayo, Monaghan, Offaly, Roscommon & Wicklow

Gordon Barry
+353 (86) 821 6561
gbarry@osdoors.com

Louise Downey
+44 (0) 28 3754 7291
ldowney@osdoors.com

Louth, Meath, Westmeath

Mark McNamee
+353 (86) 102 7046
mmcnamee@osdoors.com

Carlow, Dublin, Kildare, Kilkenny, Tipperary, Wexford & Waterford

Gordon Ross
+353 (87) 494 5117
gross@osdoors.com

Trade Counter - Dublin (Santry)

Reception
+353 (0) 1 852 3002
trade@osdoors.com

Shaun Barnes
+353 (86) 467 9233 (2)
sbarnes@osdoors.com

Trade Counter - Dublin (Clondalkin)

Reception
+353 (0) 1 572 6850
trade@osdoors.com

Shaun Barnes
+353 (86) 467 9233 (2)
sbarnes@osdoors.com

England, Scotland & Wales

Tim Dillon
tdillon@osdoors.com
sales@osdoors.com

OS Express - Customer Services
+44 (0) 28 37 542 299
express@osdoors.com

Geraldine Donaghy OS Express
+44 (0) 28 37 547 289
gdonaghy@osdoors.com

Stace Alibone OS Express
078 0317 8449
salibone@osdoors.com

Trade Counter - Manchester

Reception
0161 511 4317
manchester@osdoors.com

Natalie Hazelhurst
077 1990 4028
nhazelhurst@osdoors.com

Norman Yates
075 9344 0177
nyates@osdoors.com



Logistics

Northern Ireland / Republic of Ireland / UK — O&S Doors Ltd operate with a policy of making deliveries according to an area timetable. Delivery days for customers located in Northern Ireland, Republic of Ireland and UK are detailed in the despatch timetable below. Please note this despatch time-table may be subject to amendment.

Orders with a total value of less than £250 / €400 NETT incur a delivery charge of £15 / €22.*

Monday	Tuesday	Wednesday	Thursday**	Friday
Armagh	Bangor	Ballymena	Carlow	Castledawson
Banbridge	Ballymoney	Castledawson	Clare	Cookstown
Castleblaney	Belfast	Cavan	Cork	Rasharkin
Dublin Clondalkin	Carrickmore	Claudy	Dublin Clondalkin	
Dublin Santry	Carryduff	Coleraine	Dublin Santry	
Dundalk	Craigavon	Cookstown	Galway	
Drogheda	Coalisland	Derry	Kerry	
Louth	Downpatrick	Donegal	Kildare	
Manchester	Dublin Clondalkin	Dublin Clondalkin	Kilkenny	
Monaghan	Dublin Santry	Dublin Santry	Leitrim	
Newry	Dungannon	Dungiven	Limerick	
	Kilkeel	Enniskillen	Longford	
	Lurgan	Fermanagh	Manchester	
	Manchester	Kilrea	Mayo	
	Newcastle	Letterkenny	Offaly	
	Omagh	Limavady	Portlaoise	
	Portadown	Magherafelt	Roscommon	
	Sixmilecross	Manchester	Sligo	
	Sion Mills	Randalstown	Tipperary	
	Strabane	Rasharkin	Waterford	
			West Meath	
			Wexford	
			Wicklow	

**Thursday is a two day run. Some customers may not receive goods until Friday.

Dublin Santry — Unit 9, Boeing Rd, Kilmore Big, Dublin, D17 P863, Ireland

Dublin Clondalkin — Weatherwell Business Park, Units F2/F3, Clondalkin, Co. Dublin, D22 HN36, Ireland

England, Scotland and Wales — Deliveries to England, Scotland and Wales are set per customer account and are subject to change depending on volume of individual deliveries.

Manchester — Units 3A & 3B, Castlehill Industrial Estate, Horsfield Way, Bredbury, SK6 2SU

Special / Express Deliveries — Deliveries outside of the normal arrangements are only available in exceptional circumstances and are subject to delivery surcharge. O&S Doors Ltd accept no liability for any damages incurred in transit in such circumstances.

Sign On Receipt — We kindly request that on receipt of goods, a delivery note is signed and returned to our driver. Your co-operation in this matter is appreciated.

*Delivery charges may be subject to change.

For Ultimate Design Flexibility **Choose 5G.** Next Generation Vinyl Doors



5G is a product of our determination and attention to detail. We use the highest quality materials, the most reliable adhesives, the latest advancements in finishing techniques and manufacturing technology.

Through 5G you have the ultimate design flexibility, with 70+ Door Styles to choose from and an extensive range of finishes including **Embossed Woodgrain Textures, Legno, Matt, Superior Matt & Gloss.**

NEXT GENERATION
CORE SPECIFICATION

NEXT GENERATION
**MANUFACTURING
TECHNOLOGY**

NEXT GENERATION
**3D THERMOFORMED
POLYMER FINISHES**

NEXT GENERATION
ADHESIVES

NEXT GENERATION
DESIGN EXPERTISE





STEP 1 / Choose your door style

Use the Door Style Selection Guide on pages 16 - 31 as a quick reference to find the specific Door Style you need. We have 70+ Door Styles to choose from. These are broken down into the following 8 sections:

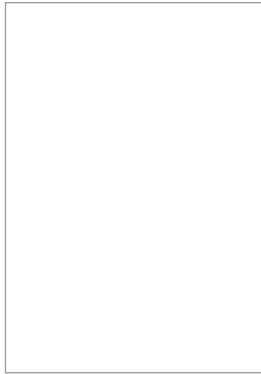

Modern / 9 Door Styles
See Page 16



Handleless / 10 Door Styles
See Page 18

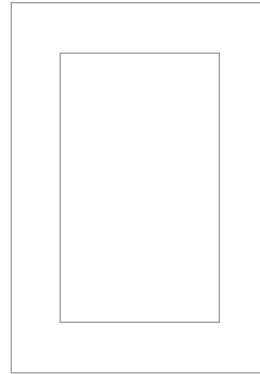

Plain Shaker / 9 Door Styles
See Page 20

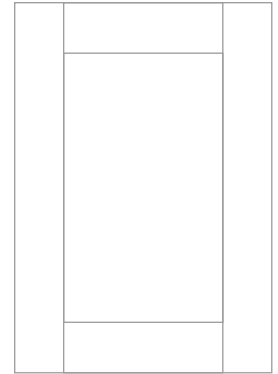

Lined Shaker / 8 Door Styles
See Page 22

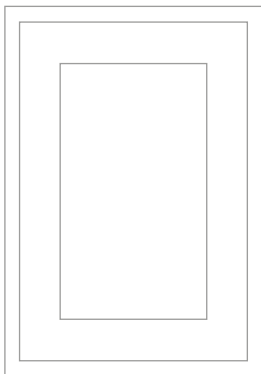

Mock In-Frame / 8 Door Styles
See Page 24

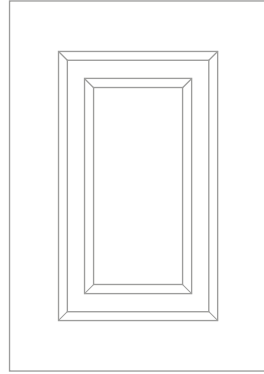

Raised Panel / 12 Door Styles
See Page 26

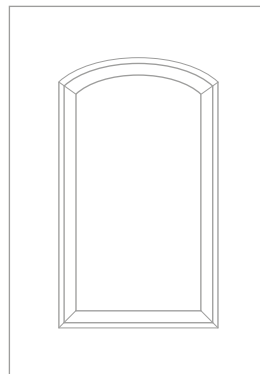

Arched / 9 Door Styles
See Page 28

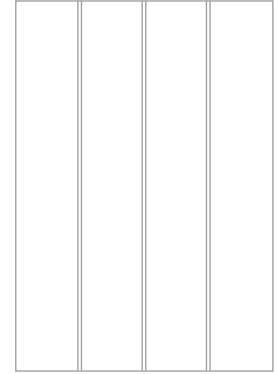

Grooved / 13 Door Styles
See Page 30

Our 5G Vinyl door range is broken down into 4 Price Bands. The complexity of each individual Door Style design will determine which price category it fits into.

- Price Band A
- Price Band B
- Price Band C
- Price Band D



5G Vinyl MTM | User Guide

STEP 2 / Choose your finish

Choose from 3 finish types: Matt, Superior Matt and Gloss. Please note not every door style is available within every finish. Use the key under each door image to see what finishes are available for that door. You can also use the key to see if that door style is compatible with our new Handleless Rail System.

See page 33 for the full list of 5G Vinyl finishes.

M Matt (incl. Wood Grain / Legno)

S Superior Matt

G Gloss

STEP 3 / Choose your sizes

Standard size guides are available on page 36, however all our 5G Vinyl ranges are available Made to Measure.

STEP 4 / Place your order

To place your order we recommend using our dedicated online ordering service. It gives you full access to our extensive product range, real time inventory status and live pricing. It's easy to use and allows you to order directly and independently at any time of day. You'll save both time and money creating quotes at the click of a button and placing orders with instant order confirmation.

To find out more about setting up your online ordering account please speak to a member of our Customer Service team on +44 (0)28 3754 9190.

Other enquiries send via email to:

Northern Ireland - Orders@osdoors.com

Republic of Ireland - Orders@osdoors.com

United Kingdom - OrdersUK@osdoors.com

Express - OrdersExpress@osdoors.com

Manchester - Manchester@osdoors.com

Orders sent to any other email will not be processed. Telephone orders will not be accepted.

For more details on the ordering process see page 6.

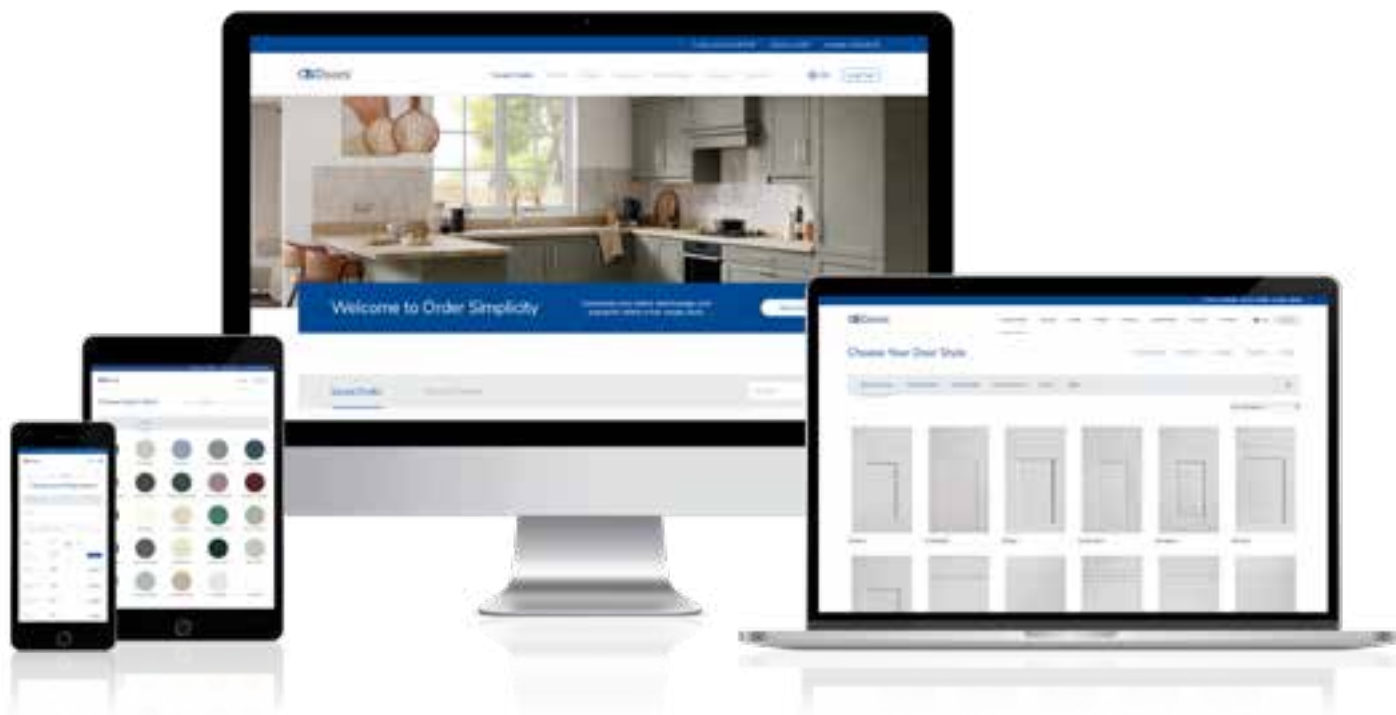

5G Vinyl Door Styles | Modern

5G Vinyl | MTM



Galaxy

M S G

Price Band A

Thickness	18mm Thick
Edge	Profile Edge 3 (See page 32)
Design	Slab Style



Cutler (Formally Duleek)

M S G

Price Band A

Thickness	18mm Thick
Edge	Profile Edge 1 (See page 32)
Design	Slab Style



Frankfurt (Formally Letterbox)

M S G

Price Band B

Thickness	18mm Thick
Edge	Profile Edge 1 (See page 32)
Design	020 Letterbox Handle Required



Oslo

M S G

Price Band A

Thickness	18mm Thick
Edge	Profile Edge 5 (See page 32)
Design	Line Groove 60mm



Euroline

M S G

Price Band A

Thickness	18mm Thick
Edge	Profile Edge 5 (See page 32)
Design	Line Groove 40mm

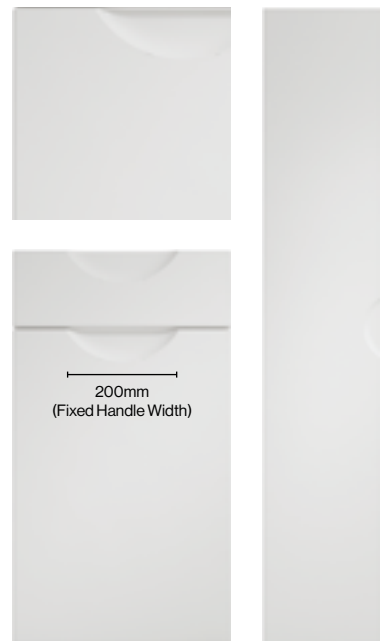

Seymour (Formally Scoop)

M S G

Price Band C

Thickness	18mm Thick
Edge	Profile Edge 1 (See page 32)
Design	010 Scoop Handle Required

5G Vinyl Door Styles | Modern



Savon (Formally Slab)



Price Band A

Thickness	18mm Thick
Edge	Profile Edge 5 (See page 32)
Design	Pillow Style



Mona



Price Band A

Thickness	18mm Thick
Edge	Profile Edge 5 (See page 32)
Design	7mm Arched Edge Detail



Marino (Formally Modena)



Price Band A

Thickness	18mm Thick
Edge	Profile Edge 1 (See page 32)
Design	18mm Thick Line Detail



Cutler and Mila / Featured in Superior Matt Heritage Green and Urban Oak.
Handles / Hampton 'D' Handle in Black / Code 136.

5G Vinyl Door Styles | Handleless

5G Vinyl | MTM



Kassel (Formally Gallo) M S G

Price Band D

Thickness	22mm Thick
Edge	Profile Edge 1 (See page 32)
Design	J-Pull Handle



Alaska (Formally Europe) M S G

Price Band B

Thickness	18mm Thick
Edge	Profile Edge 1 (See page 32)
Design	J-Pull Handle



Lane M S

Price Band D

Thickness	22mm Thick
Edge	Profile Edge 1 (See page 32)
Design	75mm Stile Width / J-Pull Handle

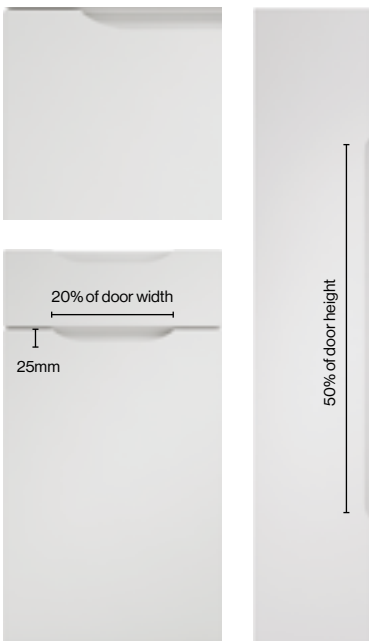

Neptune (Formally Brentford) M S G

Price Band D

Thickness	22mm Thick
Edge	Profile Edge 1 (See page 32)
Design	Variable Handle Width

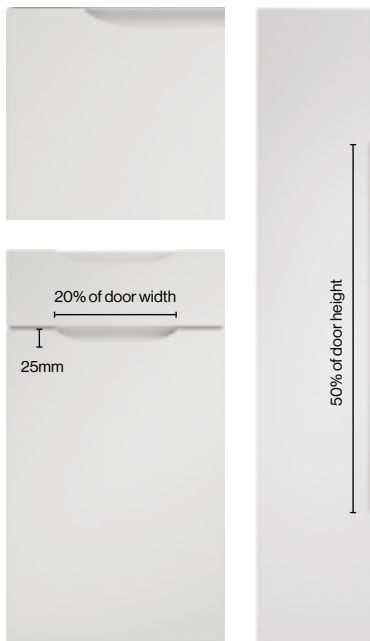

Rana (Formally Overton) M S G

Price Band B

Thickness	18mm Thick
Edge	Profile Edge 1 (See page 32)
Design	Variable Handle Width

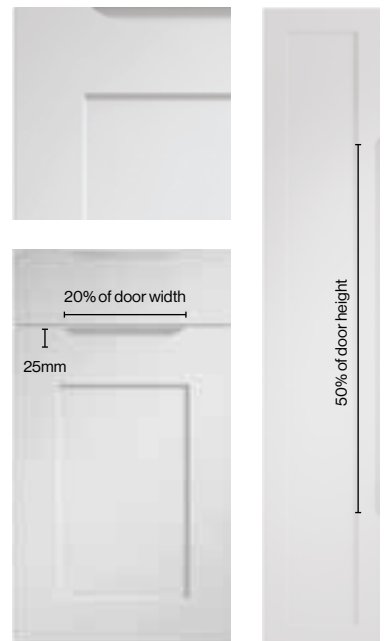

Shepford M S

Price Band D

Thickness	22mm Thick
Edge	Profile Edge 1 (See page 32)
Design	90mm Stile Width Variable Handle Width

5G Vinyl Door Styles | **Handleless**

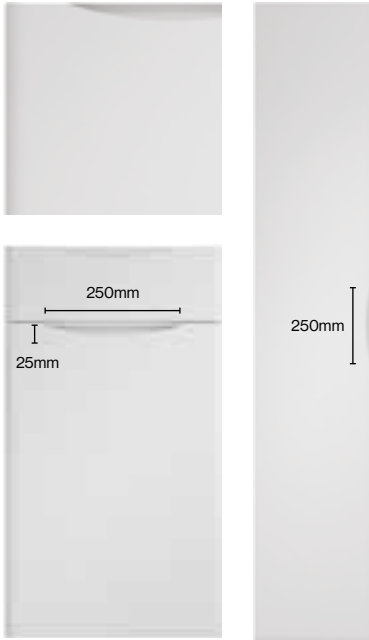

Loretto (Formerly Ryandale)



Price Band C

Thickness	18mm Thick
Edge	Profile Edge 5 (See page 32)
Design	Fixed Handle Width

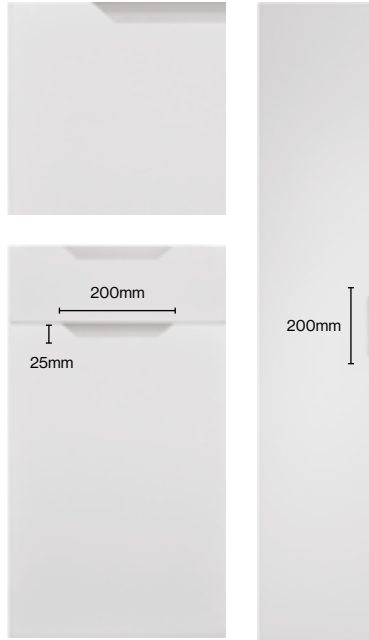

Mercury



Price Band D

Thickness	22mm Thick
Edge	Profile Edge 1 (See page 32)
Design	Fixed Handle Width

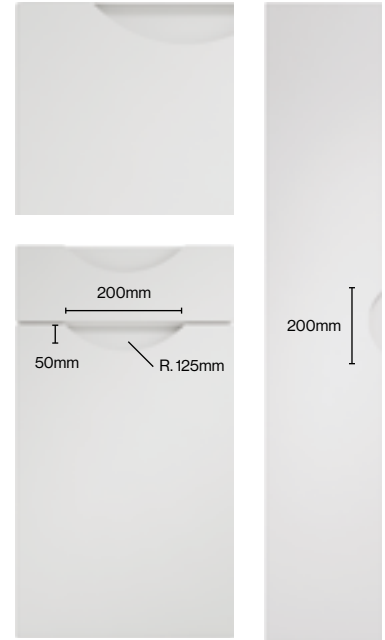

Orion (Formerly Sperrin)



Price Band C

Thickness	18mm Thick
Edge	Profile Edge 1 (See page 32)
Design	Fixed Handle Width

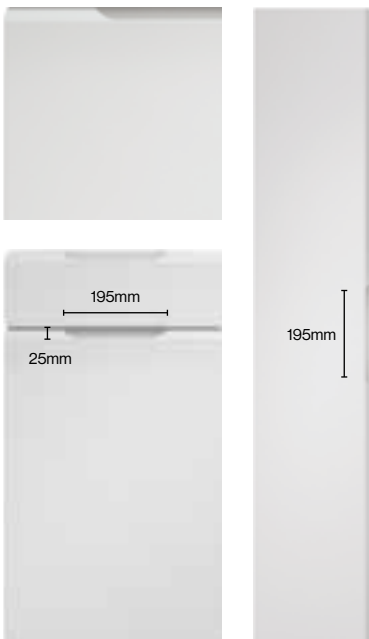

Jasper



Price Band B

Thickness	18mm Thick
Edge	Profile Edge 5 (See page 32)
Design	Fixed Handle Width



Kassel / Featured in Gloss White Grey.

5G Vinyl Door Styles | Plain Shaker



Melrose

M S

Price Band C

Thickness	18mm Thick
Edge	Profile Edge 1 (See page 32)
Design	60mm Stile Width



Lanark

M S

Price Band C

Thickness	18mm Thick
Edge	Profile Edge 1 (See page 32)
Design	70mm Stile Width



Barnbrook

M S

Price Band C

Thickness	18mm Thick
Edge	Profile Edge 1 (See page 32)
Design	80mm Stile Width



Taunton

M S

Price Band C

Thickness	18mm Thick
Edge	Profile Edge 1 (See page 32)
Design	90mm Stile Width



Trenton

M S

Price Band C

Thickness	18mm Thick
Edge	Profile Edge 1 (See page 32)
Design	100mm Stile Width



Athlone

M S

Price Band C

Thickness	18mm Thick
Edge	Profile Edge 1 (See page 32)
Design	110mm Stile Width

5G Vinyl Door Styles | Plain Shaker



Woking

M S

Price Band C

Thickness	18mm Thick
Edge	Profile Edge 1 (See page 32)
Design	60mm Stile Width



Welsford (Formally Windermere)

M S

Price Band C

Thickness	18mm Thick
Edge	Profile Edge 1 (See page 32)
Design	105mm Stile Width



Horton

M S

Price Band C

Thickness	18mm Thick
Edge	Profile Edge 1 (See page 32)
Design	70mm Stile Width



Chelsea

M S

Price Band C

Thickness	18mm Thick
Edge	Profile Edge 1 (See page 32)
Design	63mm Stile Width



Chelsea / Featured in Superior Matt Tuscan Red.
Handles / Fender Knurled 'D' Handle featured in Black / Code 134.

5G Vinyl Door Styles | Lined Shaker

5G Vinyl | MTM



Basel

M S

Price Band C

Thickness	18mm Thick
Edge	Profile Edge 1 (See page 32)
Design	60mm Stile Width



Carmen

M S

Price Band C

Thickness	18mm Thick
Edge	Profile Edge 1 (See page 32)
Design	70mm Stile Width



Allerford

M S

Price Band C

Thickness	18mm Thick
Edge	Profile Edge 1 (See page 32)
Design	80mm Stile Width



Bonn (Formerly Cologne)

M S

Price Band C

Thickness	18mm Thick
Edge	Profile Edge 1 (See page 32)
Design	90mm Stile Width



Hillwell

M S

Price Band C

Thickness	18mm Thick
Edge	Profile Edge 1 (See page 32)
Design	100mm Stile Width



Conway

M S

Price Band C

Thickness	18mm Thick
Edge	Profile Edge 1 (See page 32)
Design	110mm Stile Width



5G Vinyl Door Styles | Lined Shaker

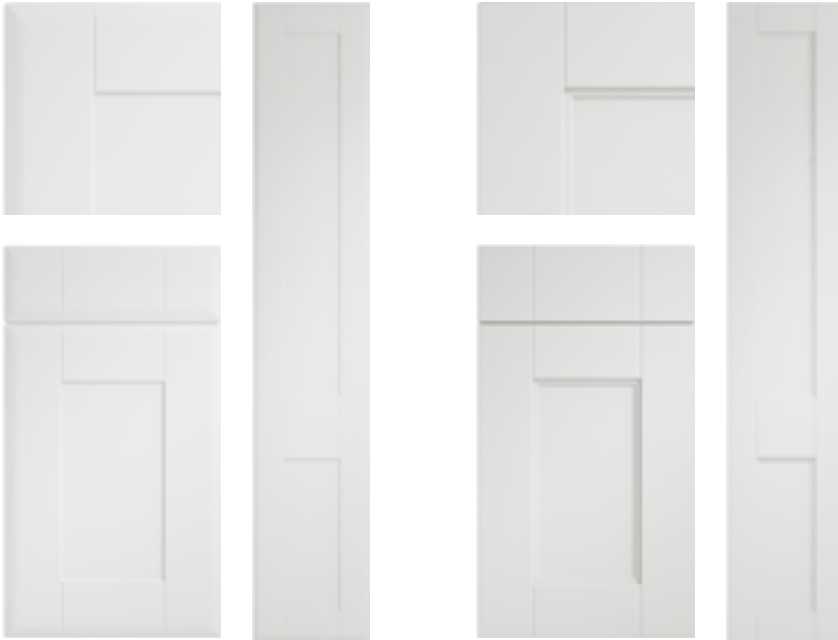

Auckland



Price Band C

Thickness	18mm Thick
Edge	Profile Edge 5 (See page 32)
Design	105mm Stile Width

Mason (Formerly Ottawa)



Price Band C

Thickness	18mm Thick
Edge	Profile Edge 1 (See page 32)
Design	100mm Stile Width



Base / Featured in Legno Reed.
Handles / Fender Knurled 'D' Handle featured in Satin Brass / Code 135.

5G Vinyl Door Styles | Mock In-Frame



Vilo

M S

Price Band C

Thickness	18mm Thick
Edge	Profile Edge 3 (See page 32)
Design	10mm Stile Width



Jones

M S G

Price Band B

Thickness	18mm Thick
Edge	Profile Edge 1 (See page 32)
Design	36mm Stile Width



Rathlin

M S

Price Band C

Thickness	18mm Thick
Edge	Profile Edge 1 (See page 32)
Design	95mm Stile Width



St. Ives

M S

Price Band C

Thickness	18mm Thick
Edge	Profile Edge 1 (See page 32)
Design	95mm Stile Width



Salisbury

M S

Price Band C

Thickness	18mm Thick
Edge	Profile Edge 1 (See page 32)
Design	90mm Stile Width



Ealing

M S

Price Band C

Thickness	18mm Thick
Edge	Profile Edge 1 (See page 32)
Design	90mm Stile Width

5G Vinyl Door Styles | **Mock In-Frame**



5G Vinyl Door Styles | Raised Panel

5G Vinyl | MTM



Siesta (Formally Surrey)

M S

Price Band B

Thickness	18mm Thick
Edge	Profile Edge 1 (See page 32)
Design	100mm Stile Width



Danforth (Formally Denton)

M S

Price Band C

Thickness	18mm Thick
Edge	Profile Edge 1 (See page 32)
Design	80mm Stile Width



Leon

M S

Price Band C

Thickness	18mm Thick
Edge	Profile Edge 1 (See page 32)
Design	70mm Stile Width



Chatham

M S

Price Band B

Thickness	18mm Thick
Edge	Profile Edge 1 (See page 32)
Design	70mm Stile Width



Monza

M S

Price Band B

Thickness	18mm Thick
Edge	Profile Edge 2 (See page 32)
Design	56mm Stile Width



Calcutta

M S

Price Band B

Thickness	18mm Thick
Edge	Profile Edge 2 (See page 32)
Design	64mm Stile Width

5G Vinyl Door Styles | Raised Panel



Lincoln

M S

Price Band B

Thickness	18mm Thick
Edge	Profile Edge 1 (See page 32)
Design	75mm Stile Width



Hazel (Formally Keeley)

M S

Price Band B

Thickness	18mm Thick
Edge	Profile Edge 1 (See page 32)
Design	78mm Stile Width



Gibson

M S

Price Band B

Thickness	18mm Thick
Edge	Profile Edge 1 (See page 32)
Design	78mm Stile Width



Amsterdam

M S

Price Band B

Thickness	18mm Thick
Edge	Profile Edge 2 (See page 32)
Design	67mm Stile Width



Ashford

M S G

Price Band B

Thickness	18mm Thick
Edge	Profile Edge 5 (See page 32)
Design	75mm Stile Width



Capital Square

M S G

Price Band B

Thickness	18mm Thick
Edge	Profile Edge 5 (See page 32)
Design	60mm Stile Width

5G Vinyl Door Styles | Arched

5G Vinyl | MTM



Annabelle

M S

Price Band B

Thickness	18mm Thick
Edge	Profile Edge 2 (See page 32)
Design	55mm Stile Width



Windsor

M S

Price Band B

Thickness	18mm Thick
Edge	Profile Edge 4 (See page 32)
Design	65mm Stile Width



Cathedral Single

M S

Price Band B

Thickness	18mm Thick
Edge	Profile Edge 2 (See page 32)
Design	50mm Stile Width



Verona

M S

Price Band B

Thickness	18mm Thick
Edge	Profile Edge 4 (See page 32)
Design	54mm Stile Width



Hayette Single

M S

Price Band B

Thickness	18mm Thick
Edge	Profile Edge 2 (See page 32)
Design	50mm Stile Width



Capital Arch

M S

Price Band B

Thickness	18mm Thick
Edge	Profile Edge 5 (See page 32)
Design	60mm Stile Width

5G Vinyl Door Styles | Arched



Bourbon

M S

Price Band C

Thickness	18mm Thick
Edge	Profile Edge 2 (See page 32)
Design	64mm Stile Width



Madrid

M S

Price Band C

Thickness	18mm Thick
Edge	Profile Edge 4 (See page 32)
Design	64mm Stile Width



Saxon Arch

M S

Price Band C

Thickness	18mm Thick
Edge	Profile Edge 2 (See page 32)
Design	60mm Stile Width



Verona / Featured in Matt Taupe Grey.
Handles / Oxford Knob featured in Chrome / Code 126.

5G Vinyl Door Styles | Grooved

5G Vinyl | MTM



Olivia

M S

Price Band C

Thickness	18mm Thick
Edge	Profile Edge 1 (See page 32)
Design	5mm round lines / 2mm deep / 5mm flats in between grooves
T&G Panel	For this range will be supplied matching the door.



Ella

M S

Price Band C

Thickness	18mm Thick
Edge	Profile Edge 1 (See page 32)
Design	5mm round lines / 2mm deep / 10mm flats in between grooves
T&G Panel	For this range will be supplied matching the door.



Aria

M S

Price Band C

Thickness	18mm Thick
Edge	Profile Edge 1 (See page 32)
Design	5mm round lines / 2mm deep / 15mm flats in between grooves
T&G Panel	For this range will be supplied matching the door.



Mila

M S

Price Band C

Thickness	18mm Thick
Edge	Profile Edge 1 (See page 32)
Design	5mm round lines / 2mm deep / 25mm flats in between grooves
T&G Panel	For this range will be supplied matching the door.



Lena

M S

Price Band C

Thickness	18mm Thick
Edge	Profile Edge 1 (See page 32)
Design	5mm round lines / 2mm deep / 50mm flats in between grooves
T&G Panel	For this range will be supplied matching the door.



Pembroke

M S

Price Band C

Thickness	18mm Thick
Edge	Profile Edge 1 (See page 32)
Design	Line spacing may vary

5G Vinyl Door Styles | Grooved



Shutter Groove



Price Band C

Thickness	18mm Thick
Edge	Profile Edge 2 (See page 32)
Design	70mm Stile Width



Newport



Price Band C

Thickness	18mm Thick
Edge	Profile Edge 1 (See page 32)
Design	90mm Stile Width



Berwick (Formally Stockholm)



Price Band C

Thickness	18mm Thick
Edge	Profile Edge 1 (See page 32)
Design	65mm Stile Width



Amalfi



Price Band B

Thickness	18mm Thick
Edge	Profile Edge 1 (See page 32)
Design	85mm Stile Width



Westbury



Price Band C

Thickness	18mm Thick
Edge	Profile Edge 2 (See page 32)
Design	70mm Stile Width



Saxon Square



Price Band C

Thickness	18mm Thick
Edge	Profile Edge 2 (See page 32)
Design	60mm Stile Width

5G Vinyl Door Styles | Profile Edge Specifications

Door Style Category	Door Style Name	Profile Edge	Price Band	M	S	G
Modern	Galaxy	Edge 3	Band A	●	●	●
Modern	Cutler	Edge 1	Band A	●	●	●
Modern	Frankfurt	Edge 1	Band B	●	●	●
Modern	Savon	Edge 5	Band A	●	●	●
Modern	Mona	Edge 5	Band A	●	●	●
Modern	Marino	Edge 1	Band A	●	●	●
Modern	Oslo	Edge 5	Band A	●	●	●
Modern	Euroline	Edge 5	Band A	●	●	●
Modern	Saymour	Edge 1	Band C	●	●	●
Handleless	Kassel	Edge 1	Band D	●	●	●
Handleless	Alaska	Edge 1	Band B	●	●	●
Handleless	Lane	Edge 1	Band D	●	●	×
Handleless	Loretto	Edge 5	Band C	●	●	●
Handleless	Mercury	Edge 1	Band D	●	●	●
Handleless	Orion	Edge 1	Band C	●	●	●
Handleless	Neptune	Edge 1	Band D	●	●	●
Handleless	Rana	Edge 1	Band B	●	●	●
Handleless	Shepford	Edge 1	Band D	●	●	×
Handleless	Jasper	Edge 5	Band B	●	●	●
Plain Shaker	Melrose	Edge 1	Band C	●	●	×
Plain Shaker	Lanark	Edge 1	Band C	●	●	×
Plain Shaker	Barnbrook	Edge 1	Band C	●	●	×
Plain Shaker	Woking	Edge 5	Band C	●	●	×
Plain Shaker	Welsford	Edge 1	Band C	●	●	×
Plain Shaker	Horton	Edge 1	Band C	●	●	×
Plain Shaker	Taunton	Edge 1	Band C	●	●	×
Plain Shaker	Trenton	Edge 1	Band C	●	●	×
Plain Shaker	Athlone	Edge 1	Band C	●	●	×
Plain Shaker	Chelsea	Edge 1	Band C	●	●	×
Lined Shaker	Basel	Edge 1	Band C	●	●	×
Lined Shaker	Carmen	Edge 1	Band C	●	●	×
Lined Shaker	Allerford	Edge 1	Band C	●	●	×
Lined Shaker	Auckland	Edge 5	Band C	●	●	×
Lined Shaker	Mason	Edge 1	Band C	●	●	×
Lined Shaker	Bonn	Edge 1	Band C	●	●	×
Lined Shaker	Hillwell	Edge 1	Band C	●	●	×
Lined Shaker	Conway	Edge 1	Band C	●	●	×
Mock In-frame	Vilo	Edge 3	Band C	●	●	×
Mock In-frame	Jones	Edge 1	Band B	●	●	●
Mock In-frame	Rathlin	Edge 1	Band C	●	●	×
Mock In-frame	St Ives	Edge 1	Band C	●	●	×
Mock In-frame	Salisbury	Edge 1	Band C	●	●	×
Mock In-frame	Ealing	Edge 1	Band C	●	●	×
Raised Panel	Siesta	Edge 1	Band B	●	●	×
Raised Panel	Danforth	Edge 1	Band C	●	●	×
Raised Panel	Leon	Edge 1	Band C	●	●	×
Raised Panel	Lincoln	Edge 1	Band B	●	●	×
Raised Panel	Hazel	Edge 1	Band B	●	●	×
Raised Panel	Gibson	Edge 1	Band B	●	●	×
Raised Panel	Chatham	Edge 1	Band B	●	●	×
Raised Panel	Monza	Edge 2	Band B	●	●	×
Raised Panel	Calcutta	Edge 2	Band B	●	●	×
Raised Panel	Amsterdam	Edge 2	Band B	●	●	×
Raised Panel	Ashford	Edge 5	Band B	●	●	●
Raised Panel	Capital Square	Edge 5	Band B	●	●	●

Door Style Category	Door Style Name	Profile Edge	Price Band	M	S	G
Arched	Annabelle	Edge 2	Band B	●	●	×
Arched	Windsor	Edge 4	Band B	●	●	×
Arched	Cathedral Single	Edge 2	Band B	●	●	×
Arched	Bourbon	Edge 2	Band C	●	●	×
Arched	Madrid	Edge 5	Band C	●	●	×
Arched	Saxon Arch	Edge 2	Band C	●	●	×
Arched	Verona	Edge 4	Band B	●	●	×
Arched	Hariette Single	Edge 2	Band B	●	●	×
Arched	Capital Arch	Edge 5	Band B	●	●	×
Grooved	Olivia	Edge 1	Band C	●	●	×
Grooved	Ella	Edge 1	Band C	●	●	×
Grooved	Aria	Edge 1	Band C	●	●	×
Grooved	Mila	Edge 1	Band C	●	●	×
Grooved	Lena	Edge 1	Band C	●	●	×
Grooved	Pembrook	Edge 1	Band C	●	●	×
Grooved	Shutter Groove	Edge 2	Band C	●	●	×
Grooved	Newport	Edge 1	Band C	●	●	×
Grooved	Berwick	Edge 1	Band C	●	●	×
Grooved	Amalfi	Edge 1	Band B	●	●	×
Grooved	Westbury	Edge 2	Band C	●	●	×
Grooved	Saxon Square	Edge 2	Band C	●	●	×

● Available × Not Available

Please note the Profile Edge is set per Door Style.
The Profile Edge is not interchangeable across Door Styles.

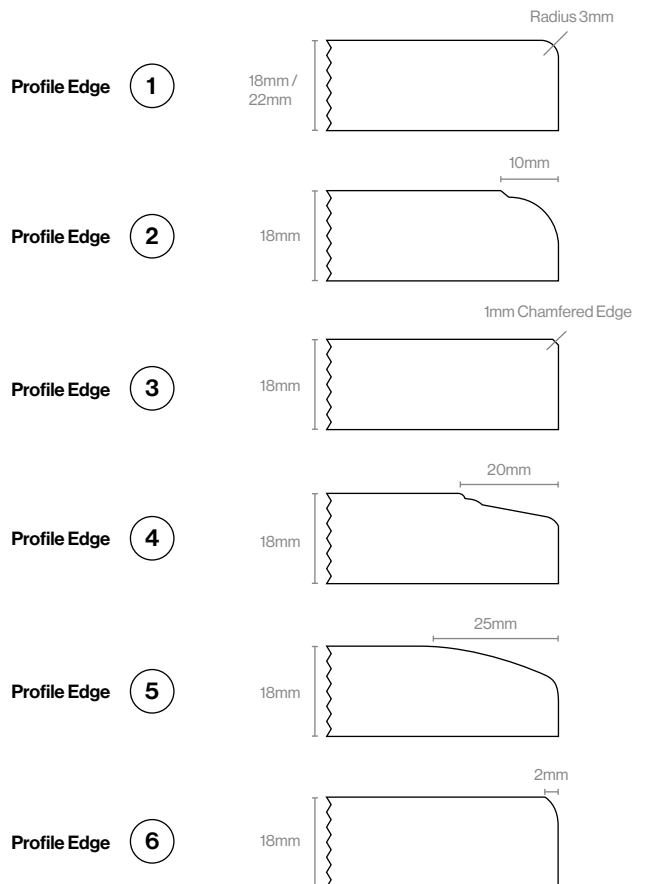

5G Vinyl | Colours / Finishes

M Matt Finishes | Woodgrain Effects

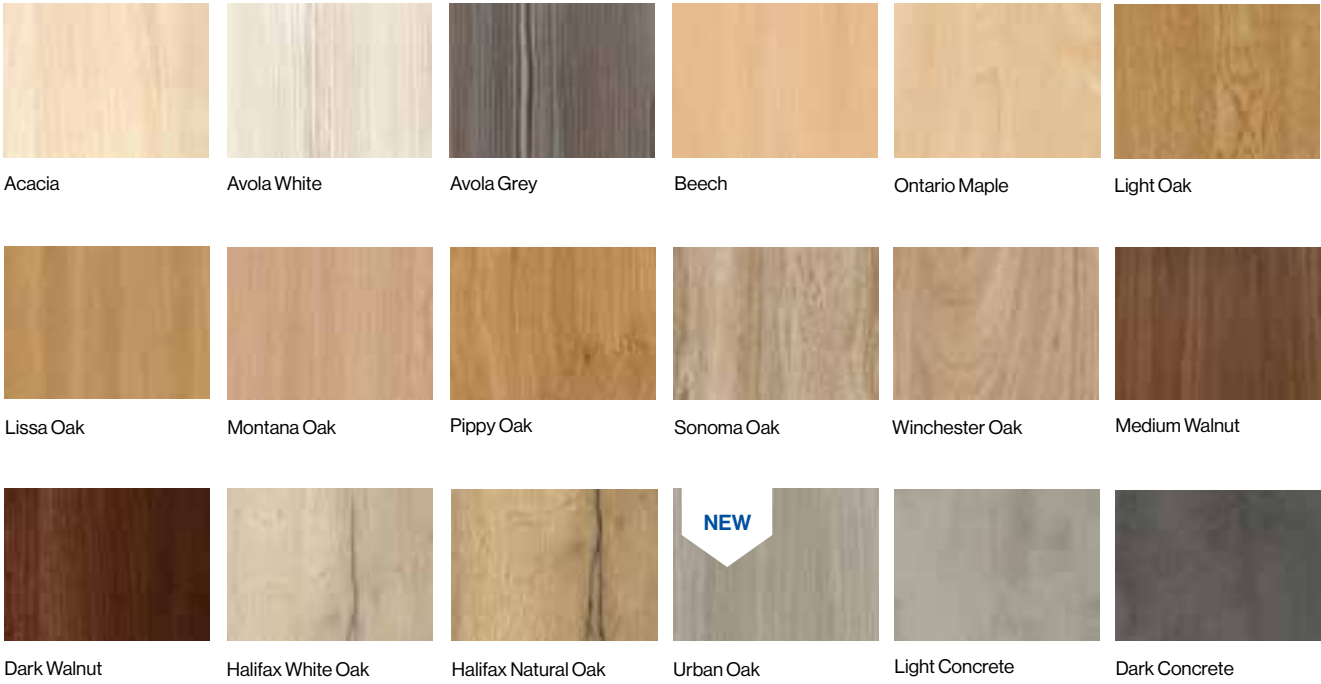

M Matt Finishes | Legno



5G Vinyl | Colours / Finishes

M Matt Finishes | Smooth

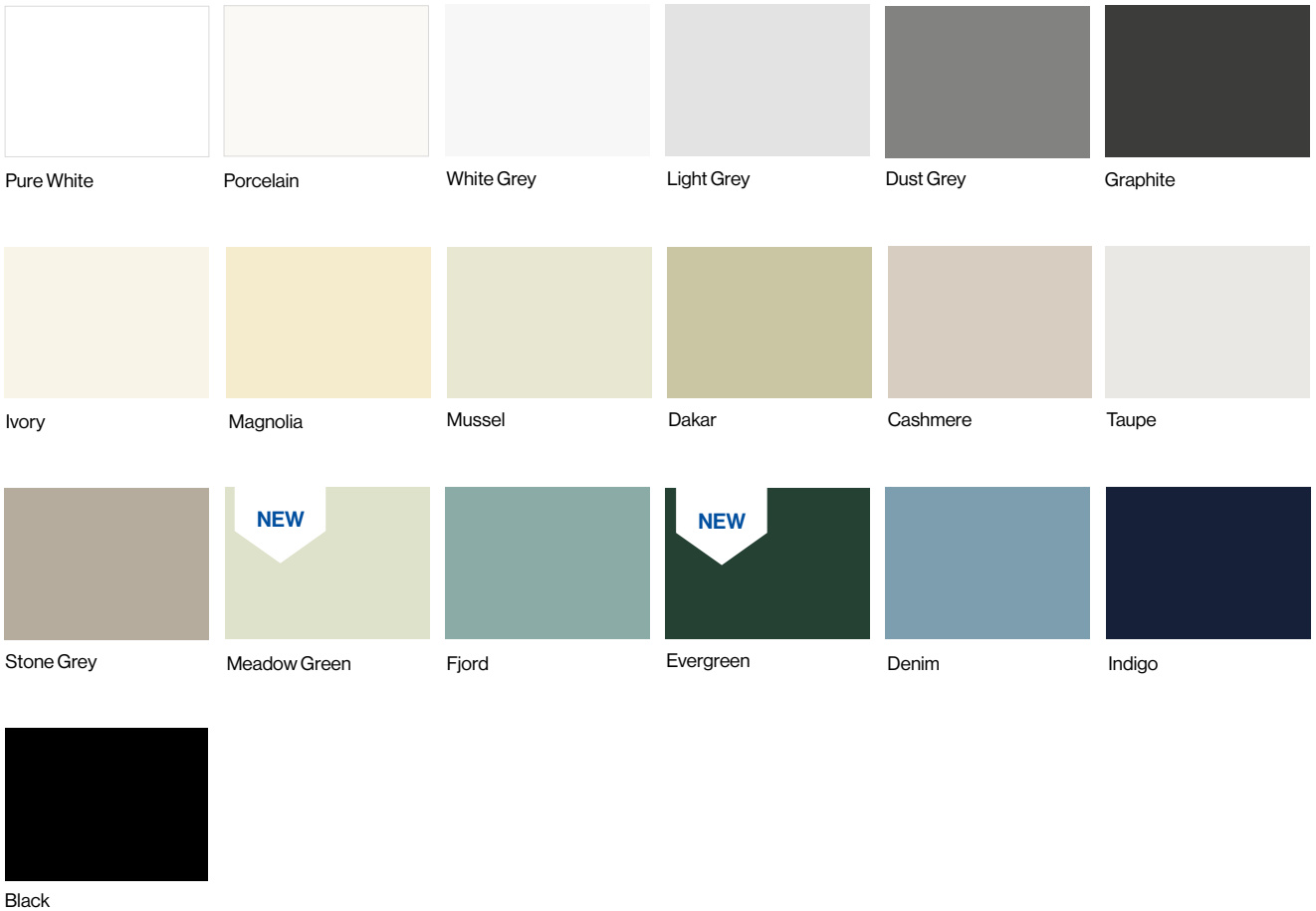

S Superior Matt Finishes | Super Smooth Matt Laminate Uni-Colours



5G Vinyl | Colours / Finishes

G Gloss Finishes | High Gloss Uni-Colours and Metallics

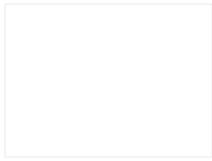

Gloss White

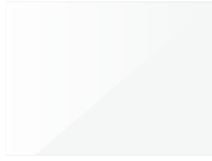

Gloss White Grey



Gloss Light Grey



Gloss Dust Grey



Gloss Graphite



Gloss Black



Gloss Oyster

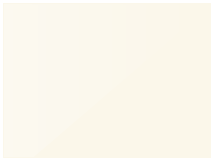

Gloss Ivory



Gloss Cream



Gloss Mussel



Gloss Dakar



Gloss Latte



Gloss Cappuccino



Gloss Cashmere



Gloss Stone Grey



Gloss Red



Gloss Aubergine



Gloss Slate



Gloss Denim



Gloss Marine Blue



Gloss Heritage Green



Gloss Metallic Anthracite
(While Stock Lasts)



Alaska Handleless featured in Gloss Light Grey

5G Vinyl | Door and Drawer Sizes

5G Vinyl | MTM



Kitchen Door Sizes				
Doors and Drawer Sizes		MTM	Curved Door Sizes	MTM
115 x 596	355 x 496	715 x 546	715 x 300	
140 x 296	355 x 596	715 x 596	895 x 300	
140 x 396	355 x 796	895 x 296	1245 x 300	
140 x 446	355 x 896	895 x 396	1965 x 300	
140 x 496	355 x 996	895 x 446		
140 x 596	450 x 596	895 x 496		
140 x 796	500 x 596	895 x 596		
140 x 896	570 x 296	980 x 596		
140 x 996	570 x 396	1060 x 396		
175 x 396	570 x 446	1060 x 496		
175 x 496	570 x 496	1060 x 596		
175 x 596	570 x 596	1245 x 296		
175 x 796	715 x 146	1245 x 396		
175 x 896	715 x 246	1245 x 446		
175 x 996	715 x 296	1245 x 496		
283 x 496	715 x 313	1245 x 596		
283 x 596	715 x 346			
283 x 796	715 x 396			
283 x 896	715 x 446			
283 x 996	715 x 496			

Bedroom Door Sizes				
Doors and Drawer Sizes		MTM	Curved Door Sizes	MTM
215 x 296	650 x 396	2150 x 396	1495 x 300	
215 x 396	650 x 446	2150 x 446	1595 x 300	
215 x 446	650 x 496	2150 x 496	2150 x 300	
215 x 496	650 x 596	2150 x 596	2250 x 300	
215 x 546	1495 x 296	2250 x 296		
215 x 596	1495 x 396	2250 x 396		
215 x 796	1495 x 446	2250 x 446		
215 x 896	1495 x 496	2250 x 496		
215 x 996	1495 x 596	2250 x 596		
415 x 296	1595 x 296	2400 x 296		
415 x 396	1595 x 396	2400 x 396		
415 x 446	1595 x 446	2400 x 446		
415 x 496	1595 x 496	2400 x 496		
415 x 596	1595 x 596	2400 x 596		
535 x 296	1735 x 296			
535 x 396	1735 x 396			
535 x 446	1735 x 446			
535 x 496	1735 x 496			
535 x 596	1735 x 596			
650 x 296	2150 x 296			

Non-Standard Kitchen Door Sizes - Priced next door size up plus 10%.

Angled Kitchen Doors - Door price plus 50%.

Horizontal Grain - Door price plus 20%.

Drilling - Additional charge per hole.

Curved Kitchen Doors available any height up to 2250mm

Non Standard Curved Kitchen Door Sizes - Priced next door size up plus 10% (Door design permitting - see page 40 for Curved Door Style availability).

Handle-less Curved Doors are only available at 715mm, 895mm and 1245mm.

Tall or Non-Standard Handleless Curved Doors are not available.

MTM Kitchen Frames - Supplied Unglazed.

Plain Kitchen Frames - Door price plus 35%.

Georgian Kitchen Frames - Door price plus 50%.

Gloss Georgian Bedroom Frames Not Available

No Foil Doors - Priced as Matt Door Size.

No Foil Curved Doors - Priced as Matt Door Size.

Non-Standard Bedroom Door Sizes - Priced next door size up plus 10%.

Angled Bedroom Doors - Door price plus 50%.

Horizontal Grain - Door price plus 20%.

Drilling - Additional charge per hole.

Curved Bedroom Doors available any height up to 2250mm

Non Standard Curved Bedroom Door Sizes - Priced next door size up plus 10% (Door design permitting - see page 40 for Curved Door Style availability).

Handle-less Curved Doors are only available at 715mm, 895mm and 1245mm.

Tall or Non-Standard Handleless Curved Doors are not available.

MTM Bedroom Frames - Supplied Unglazed.

Plain Bedroom Frames - Door price plus 35%.

Georgian Bedroom Frames - Door price plus 50%.

Gloss Georgian Bedroom Frames Not Available

No Foil Doors - Priced as Matt Door Size.

No Foil Curved Doors - Priced as Matt Door Size.

Please note not all 5G Vinyl finishes have Matching Reverse Colours.
 Please check available Matched Reverse Colours on page 51 before ordering.
22mm Door Reverse Colour - Available in White, Ivory or Silver.
 Please note if reverse colour is unspecified, Silver reverse will be used as default.

5G Vinyl | Handleless Rail System Door Sizes



Handleless Rail System Door Sizes

Kitchen Door Sizes		Bedroom Door Sizes		
160 x 296	490 x 296	1400 x 263	1500 x 413	2150 x 563
160 x 396	490 x 396	1400 x 281	1500 x 431	2150 x 581
160 x 446	490 x 446	1400 x 313	1500 x 463	2250 x 263
160 x 496	490 x 496	1400 x 331	1500 x 481	2250 x 281
160 x 596	490 x 596	1400 x 363	1500 x 513	2250 x 313
160 x 796	685 x 146	1400 x 381	1500 x 531	2250 x 331
160 x 896	685 x 296	1400 x 413	1500 x 563	2250 x 363
160 x 996	685 x 315	1400 x 431	1500 x 581	2250 x 381
325 x 496	685 x 346	1400 x 463	2150 x 263	2250 x 413
325 x 596	685 x 396	1400 x 481	2150 x 281	2250 x 431
325 x 796	685 x 446	1400 x 513	2150 x 313	2250 x 463
325 x 896	685 x 496	1400 x 531	2150 x 331	2250 x 481
325 x 996	685 x 596	1400 x 563	2150 x 363	2250 x 513
		1400 x 581	2150 x 381	2250 x 531
		1500 x 263	2150 x 413	2250 x 563
		1500 x 281	2150 x 431	2250 x 581
		1500 x 313	2150 x 463	
		1500 x 331	2150 x 481	
		1500 x 363	2150 x 513	
		1500 x 381	2150 x 531	

Drilling - Additional charge per hole.



Plain Panel
687 x 1200mm (18mm thick)

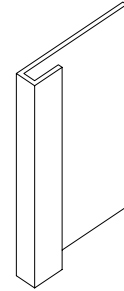

Return Cable
Made to Measure per m2
See page 216 for order form



Internal Corner Post
685 x 70 x 70mm



External Corner Post
685 x 46 x 46mm



Save time & money with **automatic pricing** through our online ordering service.

Order online at weborders.osdoors.com

Important: Always ensure doors are shielded from heat sources through the use of heat deflectors.

See page 226 for full range of heat deflector sizes.

5G Vinyl | Door Specifications

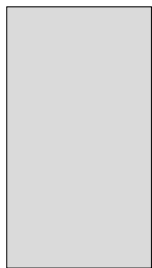

5G Kitchen Flat Panel Door

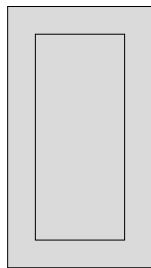

5G Kitchen Single Panel Door

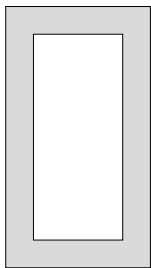

5G Kitchen Plain Frame

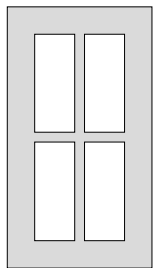

5G Kitchen Georgian Frame



5G Bedroom Standard Flat Panel Door

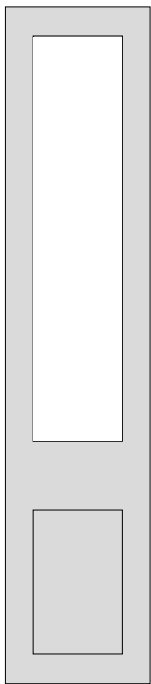

5G Bedroom Top Open Frame

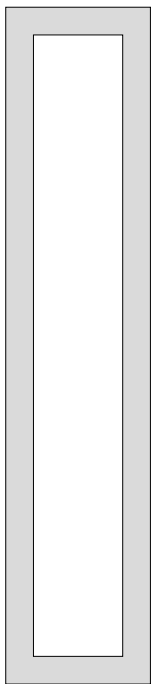

5G Bedroom Full Open Frame

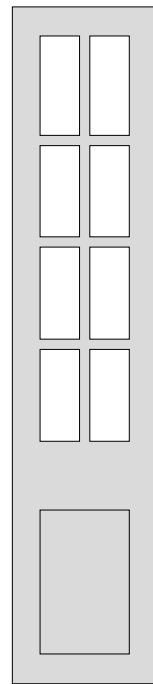

5G Bedroom Georgian Frame

STANDARD DOUBLE MID-RAIL

SPLIT DIMENSIONS



5G Kitchen Flat Panel Curved Door

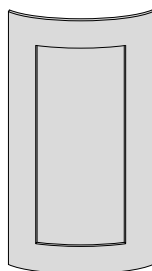

5G Kitchen Single Panel Curved Door

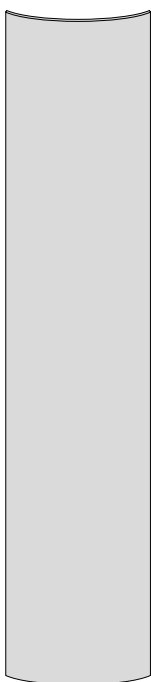

5G Bedroom Flat Panel Curved Door

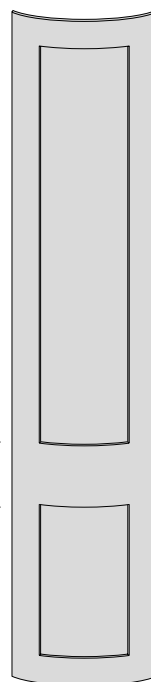

5G Bedroom Double Mid-rail Curved Door

STANDARD DOUBLE MID-RAIL

SPLIT DIMENSIONS



5G Drawer



5G Flat Panel Pan Drawer

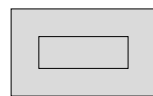

5G Single Panel Pan Drawer

5G Kitchen Doors:

Door sizes between 250mm - 1734mm high are supplied single panel as standard (door design permitting). Refer to pages 16-30 for visuals of how all standard kitchen door styles are supplied.

5G Drawers:

Design and tooling permitting, drawer sizes between 100mm - 282mm high are supplied with internal mould with horizontal grain as standard.

Pan Drawer sizes between 250mm - 282mm high are supplied as single panels with horizontal grain as standard.

Refer to pages 16-30 for visuals of how all standard drawer styles are supplied. Please note it's important to always specify either Door, Drawer or Pan Drawer when ordering to ensure that the correct rout and grain direction is used.

5G Frames:

Frames between 250mm - 1734mm high are supplied single panel as standard. Frames between 1735mm - 2400mm high are supplied with a double mid-rail which position is variable for each order (please specify required dimensions of split dimensions). The mid rail is measured from the base of the door to the centre of the mid rail unless otherwise specified.

Angled Frames are available.

5G Curved and Concave Doors:

Curved doors are made to suit 300mm x 300mm cabinets only. Height availability ranges from 570mm up to 2250mm.

Concave doors are made to suit 300mm, 330mm and 340mm cabinets. They are available at 715mm and 895mm high only. Some door styles are not available in concave.

For a full range of Curved and Concave door style availability see page 40.

5G Bedroom Doors:

Door sizes between 1735mm - 2400mm high are supplied with a double mid-rail. The mid-rail is measured from the base of the door to the centre of the mid-rail unless otherwise specified.

If an alternative mid-rail position is required this must be clearly stated when ordering.

Refer to pages 16-30 for visuals of how all standard Bedroom Door Styles are supplied.

Grain Direction:

Door sizes between 283mm - 2400mm are supplied with vertical grain as standard. Horizontal grain (up to 1220mm only) is available on request.

Drawer sizes between 100mm - 282mm are supplied with horizontal grain as standard. Vertical grain available on request.

Drilling:

All door styles are supplied un-drilled unless requested by the customer. If drilling is required, drilling instructions must clearly state full dimensions for all holes required.

5G Vinyl | Door Specifications



Angled Doors:

Angled Doors are available in both Kitchen and Bedroom door sizes. Angled Door sizes between 1735mm - 2400mm high are supplied with a double mid-rail which position is variable for each order (please specify required dimensions of split dimensions). The mid rail is measured from the base of the door to the centre of the mid rail unless otherwise specified.

Angled Open Frames are available unglazed.

When placing your order for an Angled Door you must clearly state the Angle Height and the Flat Top Width if required.

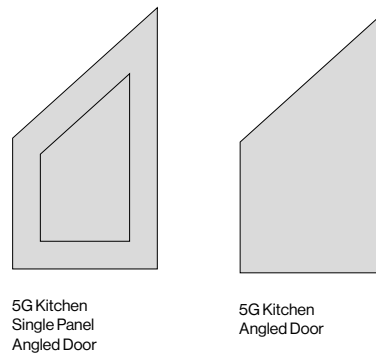

Custom Panel Bedroom Doors:

Bedroom door sizes between 1735mm - 2400mm are supplied as 2 panel doors with a double mid-rail which position is variable for each order (please specify required dimensions of split dimensions). The mid rail is measured from the base of the door to the centre of the mid rail unless otherwise specified.

If you require a 4 or 5 panel door this must be clearly stated when ordering. Both 4 and 5 panel doors are supplied with single mid-rails as standard.

Angled Doors are also available as single, double, 4 and 5 panel doors.

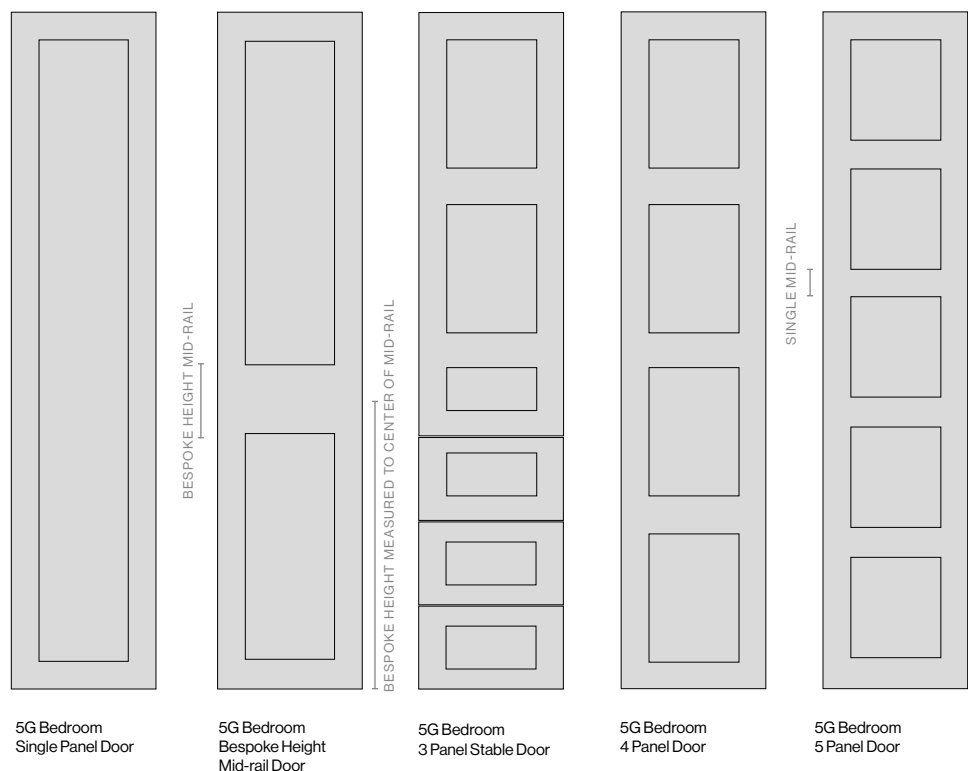

5G Door Style Category	5G Door Style Name	Curved Door	Concave Door	M	S	G
Modern	Galaxy	●	●	●	●	●
Modern	Cutler	●	●	●	●	●
Modern	Frankfurt	×	×	●	●	●
Modern	Savon	●	×	●	●	●
Modern	Mona	●	×	●	●	●
Modern	Marino	●	×	●	●	●
Modern	Oslo	●	×	●	●	●
Modern	Euroline	●	×	●	●	●
Modern	Saymour	×	×	●	●	●
Handleless	Kassel	●	●	●	●	●
Handleless	Alaska	●	×	●	●	●
Handleless	Lane	●	×	●	●	×
Handleless	Loretto	●	×	●	●	●
Handleless	Mercury	●	×	●	●	●
Handleless	Orion	●	×	●	●	●
Handleless	Neptune	●	●	●	●	●
Handleless	Rana	●	×	●	●	●
Handleless	Shepford	●	×	●	●	×
Handleless	Jasper	●	×	●	●	●
Plain Shaker	Melrose	●	×	●	●	×
Plain Shaker	Lanark	●	×	●	●	×
Plain Shaker	Barnbrook	●	×	●	●	×
Plain Shaker	Woking	●	×	●	●	×
Plain Shaker	Welsford	●	×	●	●	×
Plain Shaker	Horton	●	×	●	●	×
Plain Shaker	Taunton	●	×	●	●	×
Plain Shaker	Trenton	●	×	●	●	×
Plain Shaker	Athlone	●	×	●	●	×
Plain Shaker	Chelsea	●	×	●	●	×
Lined Shaker	Basel	●	×	●	●	×
Lined Shaker	Carmen	●	×	●	●	×
Lined Shaker	Allerford	●	×	●	●	×
Lined Shaker	Auckland	●	×	●	●	×
Lined Shaker	Mason	●	×	●	●	×
Lined Shaker	Bonn	●	×	●	●	×
Lined Shaker	Hillwell	●	×	●	●	×
Lined Shaker	Conway	●	×	●	●	×
Mock In-frame	Vilo	●	×	●	●	×
Mock In-frame	Jones	●	×	●	●	●
Mock In-frame	Rathlin	●	×	●	●	×
Mock In-frame	St Ives	●	×	●	●	×
Mock In-frame	Salisbury	●	×	●	●	×
Mock In-frame	Ealing	●	×	●	●	×
Raised Panel	Siesta	●	×	●	●	×
Raised Panel	Danforth	●	×	●	●	×
Raised Panel	Leon	×	×	●	●	×
Raised Panel	Lincoln	●	×	●	●	×
Raised Panel	Hazel	●	×	●	●	×
Raised Panel	Gibson	●	×	●	●	×
Raised Panel	Chatham	●	×	●	●	×
Raised Panel	Monza	●	×	●	●	×
Raised Panel	Calcutta	●	×	●	●	×
Raised Panel	Amsterdam	●	×	●	●	×
Raised Panel	Ashford	×	×	●	●	●
Raised Panel	Capital Square	●	×	●	●	●

5G Door Style Category	5G Door Style Name	Curved Door	Concave Door	M	S	G
Arched	Annabelle	●	×	●	●	×
Arched	Windsor	●	×	●	●	×
Arched	Cathedral Single Arch	●	×	●	●	×
Arched	Bourbon	●	×	●	●	×
Arched	Madrid	●	×	●	●	×
Arched	Saxon Arch	●	×	●	●	×
Arched	Verona	●	×	●	●	×
Arched	Hariette Single Arch	●	×	●	●	×
Arched	Capital Arch	●	×	●	●	×
Grooved	Olivia	●	×	●	●	×
Grooved	Ella	●	×	●	●	×
Grooved	Aria	●	×	●	●	×
Grooved	Mila	●	×	●	●	×
Grooved	Lena	●	×	●	●	×
Grooved	Pembrook	●	×	●	●	×
Grooved	Shutter Groove	●	×	●	●	×
Grooved	Newport	●	×	●	●	×
Grooved	Berwick	●	×	●	●	×
Grooved	Amalfi	●	×	●	●	×
Grooved	Westbury	●	×	●	●	×
Grooved	Saxon Square	●	×	●	●	×

● Available × Not Available



Curved Door: All 5G Curved Doors are designed to suit 300 x 300mm cabinet. 300mm Curved Doors are available any height up to 2250mm. Handle-less Curved Doors are only available at 715mm, 895mm and 1245mm. Tall or Non-Standard Handle-less Curved Doors are not available. All Curved Doors are available in Silver or Ivory reverse.

Concave Door: Available in 300mm, 330mm and 340mm. Concave Doors are available at 715mm and 895mm high only.

5G Vinyl | Curved Door Specifications

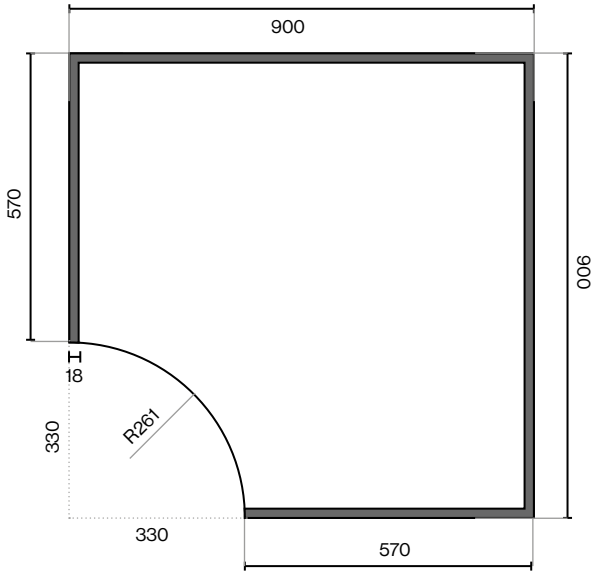

330mm Concave Door
330mm x 330mm Concave Door for 900mm Base Unit

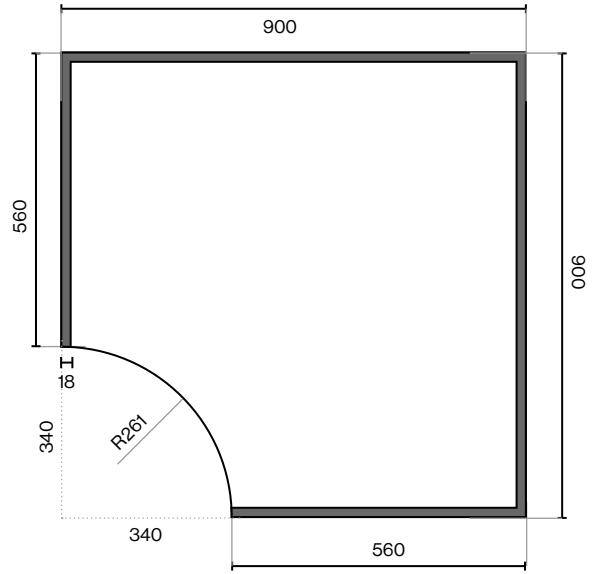

340mm Concave Door
340mm x 340mm Concave Door for 900mm Base Unit

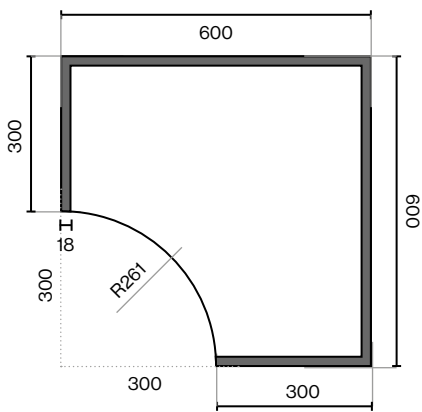

300mm Concave Door
300mm x 300mm Concave Door for 600mm Wall Unit

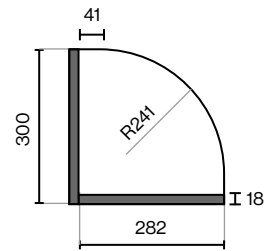

300mm Curved Door
300mm x 300mm Curved Radius Door

5G Vinyl | Technical Door Specification

M Matt | Technical Specification

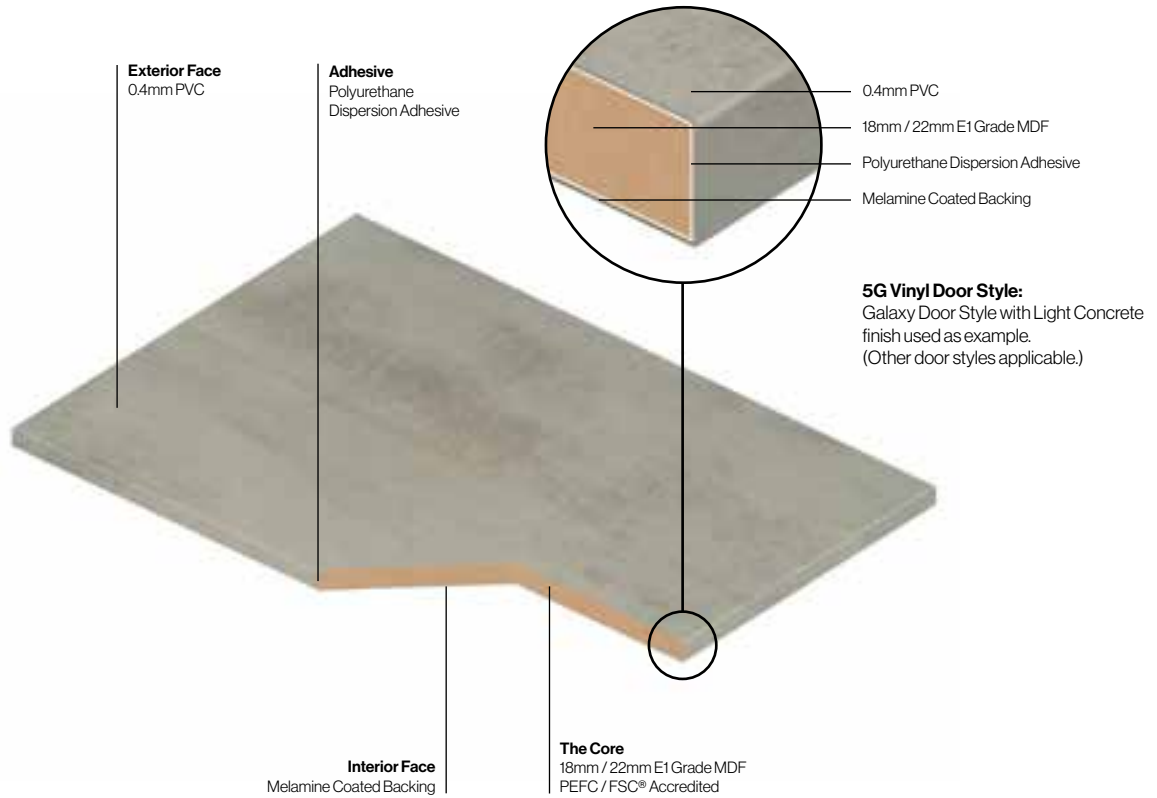

S Superior Matt | Technical Specification

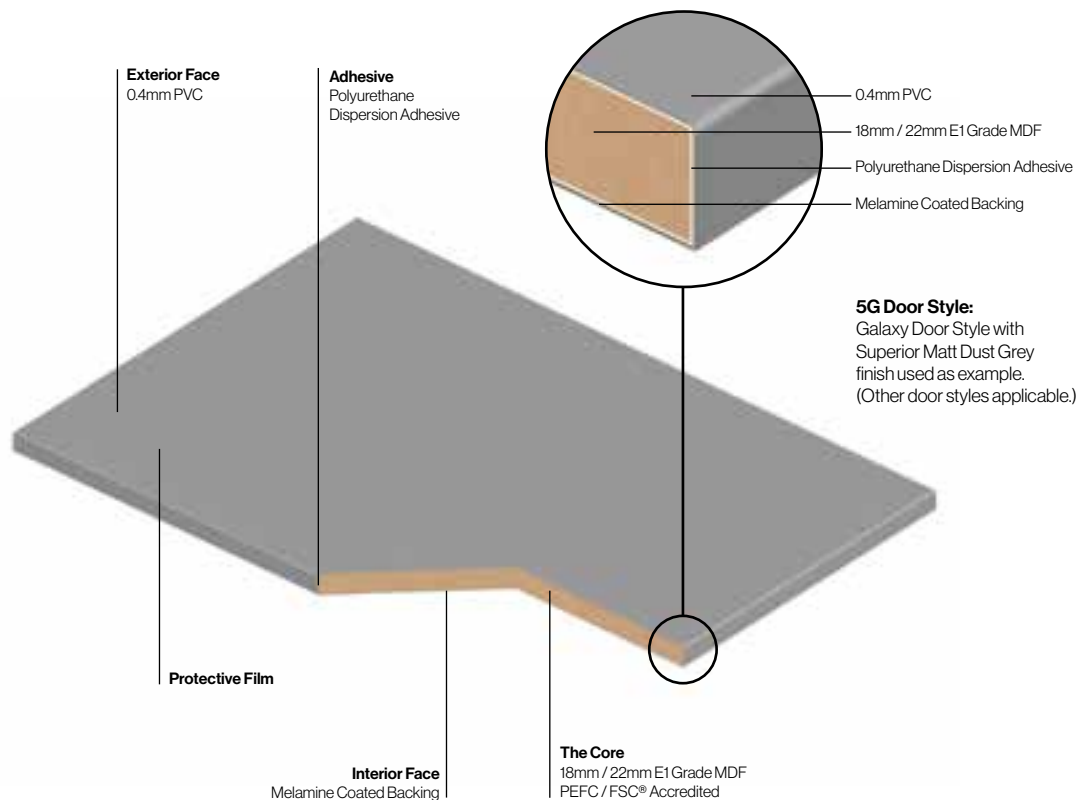

5G Vinyl | Technical Door Specification

G Gloss | Technical Specification

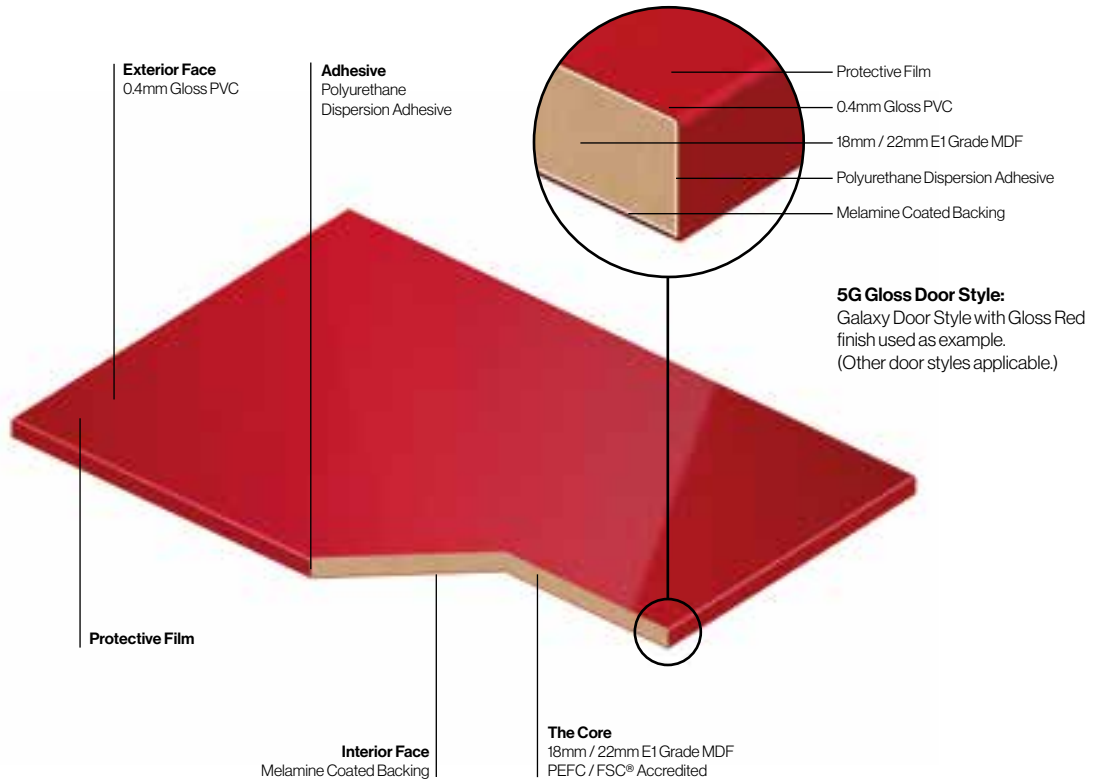

5G Vinyl | Accessories

5G Vinyl | MTM

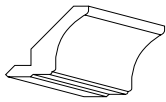

Classic Cornice
76mm (W) x 63mm (H)
3050mm Lengths

EXS

Limited Finishes. See Page 46.
Not available in Gloss.

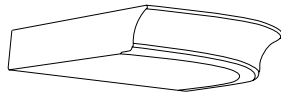

Curved Classic Cornice
364mm (L) x 364mm (W)
x 63mm (H)

MTO

Not available in Gloss.

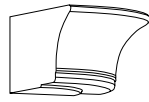

Classic Cornice Quadrant
84mm (L) x 84mm (W)
x 63mm (H)

MTO

Not available in Gloss.

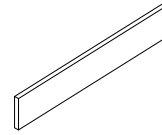

Plain Plinth
18mm (W) x 150mm (H)
3050mm Lengths

EXS

Limited Finishes. See Page 46.

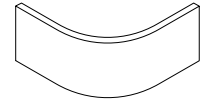

Curved Plain Plinth
300mm (L) x 300mm (W)
x 150mm (H)

MTO

Not available in Gloss.

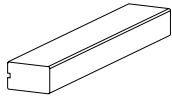

Modern Cornice / Pelmet
50mm (W) x 30mm (H)
3050mm Lengths

EXS

Limited Finishes. See Page 46.

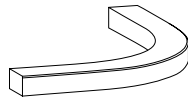

Curved Modern Cornice / Pelmet
350mm (L) x 350mm (W)
x 30mm (H)

MTM

Not available in Gloss.

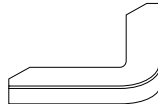

Modern Cornice / Pelmet Quadrant
220mm (L) x 220mm (W)
x 30mm (H)

MTM

Not available in Gloss.

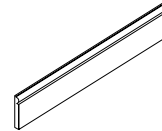

Torus Plinth
18mm (W) x 150mm (H)
3050mm Lengths

MTM

Not available in Gloss.



Curved Torus Plinth
300mm (L) x 300mm (W)
x 150mm (H)

MTM

Not available in Gloss.

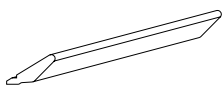

Tangent Cornice
72mm (W) x 44mm (H)
3050mm Lengths

EXS

Limited Finishes. See Page 46.



Curved Tangent Cornice
400mm (L) x 400mm (W)
x 44mm (H)

MTM

Not available in Gloss.



Tangent Cornice Quadrant
88mm (L) x 88mm (W)
x 44mm (H)

MTM

Not available in Gloss.

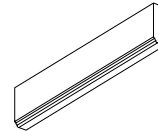

Tangent Pelmet
18mm (W) x 57mm (H)
3050mm Lengths

EXS

Limited Finishes. See Page 46.

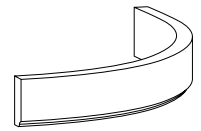

Curved Tangent Pelmet
300mm (L) x 300mm (W)
x 57mm (H)

MTM

Not available in Gloss.



MTM Corner Post
715mm (150 x 150mm Max)

MTM

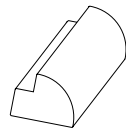

Radius Profile (R 48mm)
70mm (W) x 50mm (H)
3050mm Lengths

EXS

Limited Finishes. See Page 46.

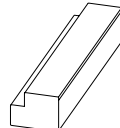

Square Base Pilaster
70mm (W) x 50mm (H)
3050mm Lengths

EXS

Limited Finishes. See Page 46.

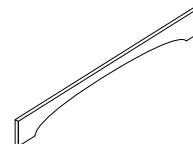

Arched Pelmet
2400mm (L) x 18mm (W)
x 200mm (H)

MTM

Not available in Gloss.

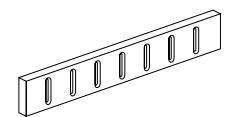

Fluted Rail
18mm (W) x 60mm (H)
2500mm Lengths

MTM

Not available in Gloss.



Plain Pilaster
100mm (W) x 900mm (H)
MTM up to 2500mm

MTM



Fluted Pilaster
100mm (W) x 900mm (H)
MTM up to 2500mm

MTM

Not available in Gloss.



Special Pilaster
100mm (W) x 900mm (H)
MTM up to 2500mm

MTM

Not available in Gloss.



Reeded Pilaster
100mm (W) x 900mm (H)
MTM up to 2500mm

MTM

Not available in Gloss.



Gun Barrel Pilaster
90mm (W) x 900mm (H)
90mm (W) x 1250 (H)
94mm (W) x 2150 (H)

EXS

Not available in Gloss.



Roman Reed Pilaster
90mm (W) x 900mm (H)
90mm/94mm (W) x 1250 (H)
94mm (W) x 2150 (H)

EXS

Not available in Gloss.

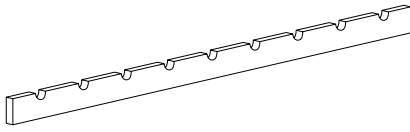

Wine Rack Rail
1200mm (L) x 18mm (W)
x 60mm (H)

MTO

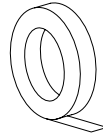

Pre-Glued Edging Tape
50m Roll.
(SERICA® Colour match only)

EXS

Limited Finishes. See Page 46.

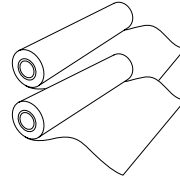

Peel 'n' Stick
Per m2

EXS

Limited Finishes. See Page 46.

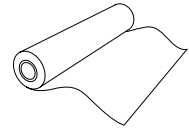

Vinyl
Per m2

EXS

Limited Finishes. See Page 46.

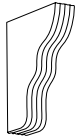

Shelf Bracket
180mm (D) x 37mm (W)
x 210mm (H)

MTO

Not available in Gloss.

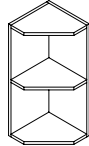

Wall Quad / Base Quad
720mm / 900mm

MTO

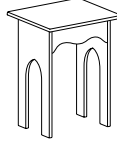

Stool
400mm (L) x 350mm (D)
x 470mm (H)

MTO

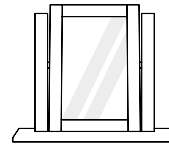

Single Square Mirror
485mm (W) x 570mm (H)

MTO

See page 48 for all full mirror dimensions

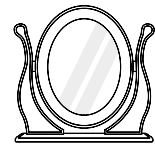

Single Oval Mirror
570mm (W) x 500mm (H)

MTO

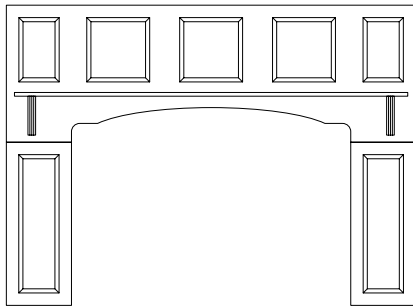

Overmantle Kit with Doors
2x Doors / 2x Shelf Brackets / 1x Mantle Shelf / 1x Back Panel

MTM

Not available in Gloss.

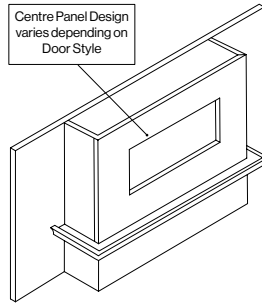

Classic Canopy
1000mm (W) x 193mm (D) x 525mm (H)

MTM

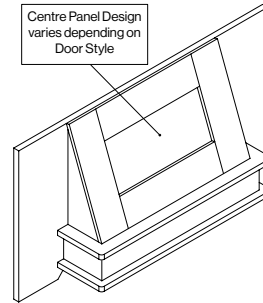

Modern Canopy
1000mm (W) x 193mm (D) x 525mm (H)

MTM

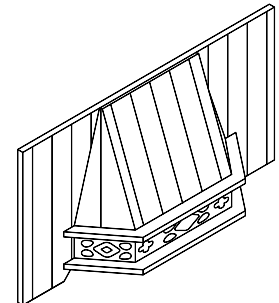

Traditional Canopy
1000mm (W) x 193mm (D) x 525mm (H)
Supplied with fretwork and T&G detail as standard.
Fretwork detail can be removed on request.

MTM

Not available in Gloss.

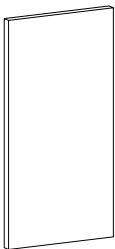

Pressed Plain Panel
18mm Thick

Standard Sizes MM:
785 x 360mm
900 x 650mm
900 x 1200mm
965 x 360mm
2400 x 360mm
2400 x 650mm

Made to Measure per m2

MTM

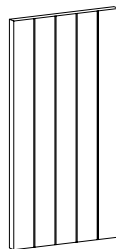

Pressed T&G Panel
18mm Thick

Standard Sizes MM:
785 x 360mm
900 x 650mm
900 x 1200mm
965 x 360mm
2400 x 360mm
2400 x 650mm

Made to Measure per m2

MTM

Not available in Gloss.

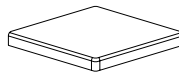

Moulded Top
Made to Measure per m2

MTM

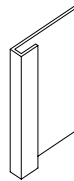

Return Gable
Made to Measure per m2
See page 238 for Order Form

MTM

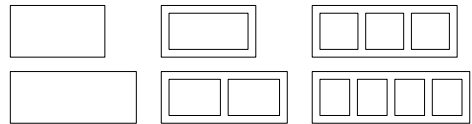

Headboards
MTM per m2.

5G Vinyl Headboards are supplied with the routed design of your chosen door style. All 5G Headboards will be supplied as single panels / flat panels as standard (Applicable to Door Style), unless otherwise specified.

Height Range: 500mm - 900mm
Width Range: 915mm - 1830mm

Standard Size MM:	Panel Availability:
3ft Headboard / 915mm	Flat Panel, Single Panel
4ft Headboard / 1208mm	Flat Panel, Single & 2 Panel
4.6ft Headboard / 1371mm	Flat Panel, Single, 2 & 3 Panel
5ft Headboard / 1510mm	Flat Panel, Single, 2, 3 & 4 Panel
6ft Headboard / 1830mm	Flat Panel, Single, 2, 3 & 4 Panel

EXS

Available Ex.Stock (Limited Finishes).
Ready for 48 hour despatch.

MTM

Available Made to Measure.
Ready for despatch in 5 working days.

5G Vinyl | Mouldings Availability

5G Vinyl | MTM

Moulding Availability Index														
Vinyl Colour	Classic Cornice	Modern Cornice Pelmet	Tangent Cornice	Tangent Pelmet	Plain Plinth	Torus Profiled Plinth	Radius Profile	Corner Post	Square Pilaster Profile	Peel & Stick	Pre-Glued Edging Tape*	Un-Glued Edging Tape*	MFC	
Acacia	×	●	×	×	●	●	×	●	×	×	●	×	×	
Avola White	×	×	●	●	●	●	×	●	×	●	●	×	×	
Avola Grey	×	●	×	×	●	●	×	●	×	●	●	×	×	
Beech	×	●	×	×	●	●	×	●	×	●	●	×	×	
Ontario Maple	×	●	×	×	●	●	×	●	×	●	●	×	×	
Dark Walnut	×	●	×	×	●	●	×	●	×	×	●	×	×	
Halifax Natural Oak	×	●	●	●	●	●	×	●	×	×	×	●	●	
Halifax White Oak	×	●	●	●	●	●	×	●	×	×	×	●	●	
Light Oak	×	●	×	×	●	●	×	●	×	●	×	×	×	
Lissa Oak	●	●	●	●	●	●	×	●	×	●	×	●	●	
Medium Walnut	×	●	●	●	●	●	×	●	×	●	●	×	×	
Montana Oak	×	●	×	×	●	●	×	●	×	●	×	×	×	
Pippy Oak	●	●	●	●	●	●	×	●	×	●	●	●	×	
Sonoma Oak	×	●	×	×	●	●	×	●	×	●	●	●	●	
Urban Oak	●	●	●	●	●	●	●	●	●	●	×	×	●	
Winchester Oak	×	●	×	×	●	●	×	●	×	●	●	×	×	
Light Concrete	×	●	×	×	●	●	×	●	×	×	×	×	×	
Dark Concrete	×	●	×	×	●	●	×	●	×	×	×	×	×	
Legno Black	●	●	●	●	●	●	●	●	●	●	×	●	●	
Legno Cashmere	●	●	●	●	●	●	●	●	●	●	●	●	●	
Legno Dakar	●	●	●	●	●	●	×	●	●	●	●	●	×	
Legno Dust Grey	●	●	●	●	●	●	●	●	●	●	●	●	●	
Legno Evergreen	●	●	●	●	●	●	●	●	●	●	×	●	●	
Legno Graphite	●	●	●	●	●	●	●	●	●	●	●	●	●	
Legno Indigo	●	●	●	●	●	●	●	●	●	●	×	●	●	
Legno Ivory	●	●	●	●	●	●	●	●	●	●	●	●	●	
Legno Light Grey	●	●	●	●	●	●	●	●	●	●	●	●	●	
Legno Marine Blue	●	●	●	●	●	●	●	●	●	●	×	●	×	
Legno Mussel	●	●	●	●	●	●	●	●	●	●	●	●	●	
Legno Reed	●	●	●	●	●	●	×	●	×	●	×	×	×	
Legno Stone Grey	●	●	●	●	●	●	×	●	●	●	●	●	×	
Legno Taupe	●	●	●	●	●	●	●	●	●	●	×	●	●	
Legno White	●	●	●	●	●	●	●	●	●	●	●	●	●	
Legno White Grey	●	●	●	●	●	●	●	●	●	●	×	●	●	
Black	×	×	×	×	●	●	×	●	×	×	●	×	×	
Cashmere	●	●	●	●	●	●	×	●	×	●	●	●	●	
Dakar	×	●	●	●	●	●	×	●	×	●	●	●	●	
Denim	×	●	×	×	●	●	×	●	×	●	●	●	●	
Dust Grey	●	●	●	●	●	●	×	●	×	●	●	●	●	
Evergreen	●	●	●	●	●	●	×	●	×	×	×	●	●	
Fjord	×	●	×	×	●	●	×	●	×	●	×	●	×	
Graphite	×	●	×	×	●	●	×	●	×	●	●	●	×	
Indigo	●	●	●	●	●	●	×	●	×	●	●	●	●	
Ivory	●	●	●	●	●	●	×	●	×	●	●	●	●	
Light Grey	●	●	●	●	●	●	●	●	×	●	●	●	●	
Magnolia	×	●	×	×	●	●	×	●	×	●	×	×	×	
Meadow Green	×	●	×	×	●	●	×	●	×	●	×	×	×	
Mussel	●	●	●	●	●	●	×	●	×	●	●	●	●	
Paintable Vinyl	×	×	×	×	●	●	×	●	×	×	×	×	×	
Porcelain	×	●	×	×	●	●	×	●	×	×	×	●	●	
Pure White	●	●	●	●	●	●	●	●	×	●	●	●	●	
Stone Grey	×	●	×	×	●	●	×	●	×	●	●	●	●	
Taupe	●	●	●	●	●	●	×	●	×	●	●	●	●	
White Grey	●	●	●	●	●	●	×	●	×	●	●	●	●	

Matt Vinyl Finishes

5G Vinyl | Mouldings Availability

Moulding Availability Index

Vinyl Colour	Classic Cornice	Modern Cornice Pelmet	Tangent Cornice	Tangent Pelmet	Plain Plinth	Torus Profiled Plinth	Radius Profile	Corner Post	Square Plaster Profile	Peel & Stick	Pre-Glued Edging Tape*	Un-Glued Edging Tape*	MFC
Superior Matt Vinyl Finishes	Superior Matt Alabaster	●	●	●	●	●	×	●	×	●	×	●	×
	Superior Matt Black	●	●	●	●	●	×	●	×	●	●	●	×
	Superior Matt Cashmere	●	●	●	●	●	×	●	×	●	●	●	×
	Superior Matt Denim	●	●	●	●	●	×	●	×	●	●	●	×
	Superior Matt Dust Grey	●	●	●	●	●	×	●	×	●	●	●	×
	Superior Matt Graphite	●	●	●	●	●	×	●	×	●	●	●	×
	Superior Matt Heritage Green	●	●	●	●	●	×	●	×	●	×	●	×
	Superior Matt Indigo	●	●	●	●	●	×	●	×	×	×	●	×
	Superior Matt Antique Rose	●	●	●	●	●	×	●	×	●	×	●	×
	Superior Matt Light Grey	●	●	●	●	●	×	●	×	●	●	●	×
	Superior Matt Marine Blue	●	●	●	×	●	×	●	×	●	×	●	×
	Superior Matt Porcelain	●	●	●	●	●	×	●	×	●	×	●	×
	Superior Matt Pebble	●	●	●	●	●	×	●	×	●	×	●	×
	Superior Matt Reed Green	●	●	●	●	●	×	●	×	●	×	×	×
	Superior Matt Stone Grey	●	●	●	●	●	×	●	×	●	●	●	×
	Superior Matt Taupe	●	●	●	●	●	×	●	×	●	×	●	×
	Superior Matt Tuscan Red	●	●	●	●	●	×	●	×	●	×	×	×
Superior Matt White Grey	●	●	●	●	●	×	●	×	×	×	●	×	
Gloss Vinyl Finishes	Gloss Aubergine	×	×	×	×	●	×	●	×	×	×	×	×
	Gloss Black	×	●	×	×	●	×	●	×	●	●	×	×
	Gloss Cappuccino	×	×	×	×	●	×	●	×	×	×	×	×
	Gloss Cashmere	×	●	×	×	●	×	●	×	●	×	×	×
	Gloss Cream	×	●	●	●	●	×	●	×	●	●	●	×
	Gloss Dakar	×	●	×	×	●	×	●	×	●	×	×	×
	Gloss Denim	×	●	×	×	●	×	●	×	×	×	×	×
	Gloss Dust Grey	×	●	×	×	●	×	●	×	×	×	×	×
	Gloss Graphite	×	●	×	×	●	×	●	×	×	×	×	×
	Gloss Heritage Green	×	●	×	×	●	×	×	×	×	×	×	×
	Gloss Ivory	×	●	●	●	●	×	●	×	●	×	×	×
	Gloss Latte	×	●	×	×	●	×	●	×	×	×	×	×
	Gloss Light Grey	×	●	●	●	●	×	●	×	●	×	×	×
	Gloss Marine Blue	×	●	×	×	●	×	●	×	×	×	×	×
	Gloss Metallic Anthracite	×	●	×	×	●	×	●	×	●	×	×	×
	Gloss Mussel	×	●	×	×	●	×	●	×	●	×	×	×
	Gloss Oyster	×	●	×	×	●	×	●	×	×	×	×	×
	Gloss Red	×	×	×	×	●	×	●	×	×	×	×	×
	Gloss Slate	×	●	×	×	●	×	×	×	×	×	×	×
	Gloss Stone Grey	×	●	×	×	●	×	●	×	×	×	×	×
Gloss White	×	●	●	●	●	×	●	×	●	●	●	×	
Gloss White Grey	×	●	×	×	●	×	●	×	●	×	×	×	

● Available Ex.Stock × Not Available ● Available Pressed to Order

*Edging Tape matches for Superior Matt finishes are colour matched only. They do not have a super smooth matt laminate finish.

5G Vinyl | Moulding Specifications

5G Vinyl | MTM

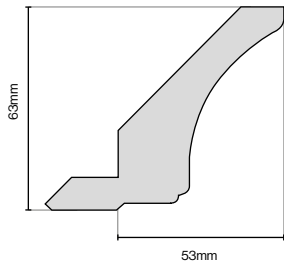

Classic Cornice
3050mm Lengths

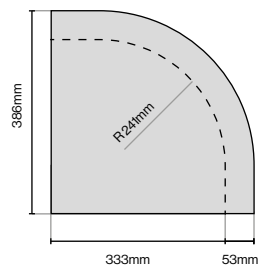

Curved Classic Cornice
386mm (L) x 336mm (W) x 63mm (H)

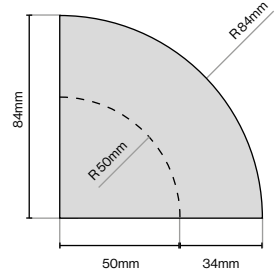

Classic Cornice Quadrant
84mm (L) x 84mm (W) x 63mm (H)

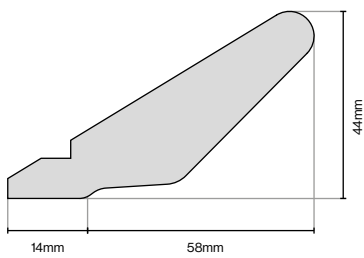

Tangent Cornice
3050mm Lengths

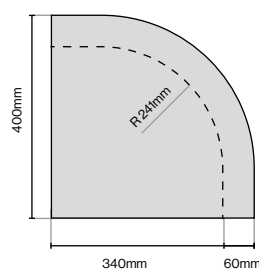

Curved Tangent Cornice
400mm (L) x 400mm (W) x 44mm (H)

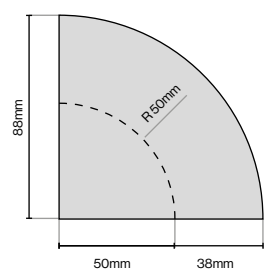

Tangent Cornice Quadrant
88mm (L) x 88mm (W) x 44mm (H)

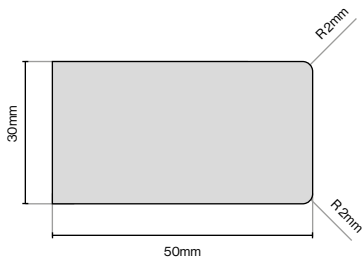

Modern Cornice / Pelmet
3050mm Lengths

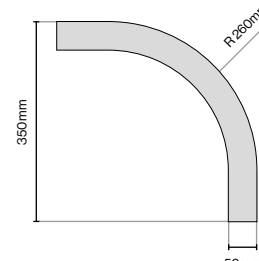

Curved Modern Cornice / Pelmet
350mm (L) x 350mm (W) x 30mm (H)

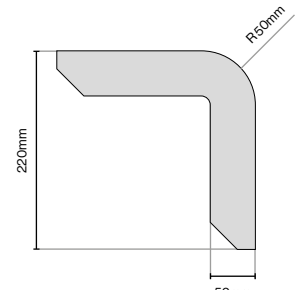

Modern Cornice / Pelmet Quadrant
220mm (L) x 220mm (W) x 30mm (H)

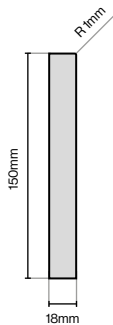

Plain Plinth
3050mm Lengths

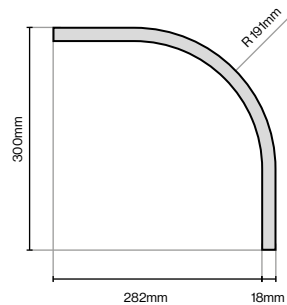

Curved Plain Plinth
300mm (L) x 300mm (W) x 150mm (H)

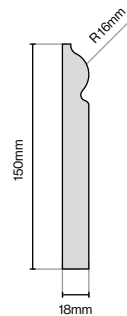

Torus Plinth
3050mm Lengths

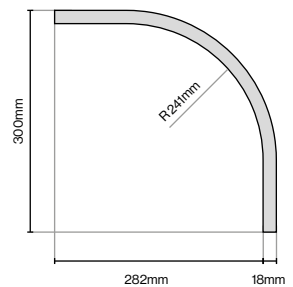

Curved Torus Plinth
300mm (L) x 300mm (W) x 150mm (H)

5G Vinyl | Moulding Specifications

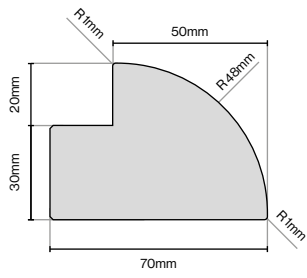

Radius Profile
3050mm Lengths

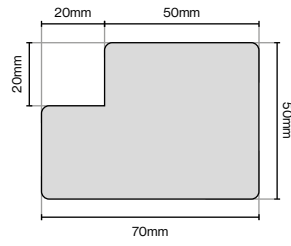

Square Pilaster
3050mm Lengths

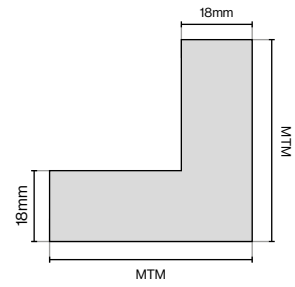

MTM Corner Post
715mm (150 x 150mm Max)

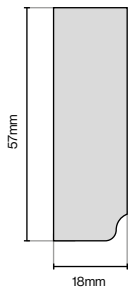

Tangent Pelmet
3050mm Lengths

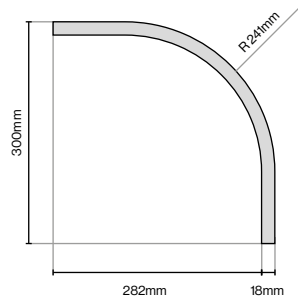

Curved Tangent Pelmet
300mm (L) x 300mm (W) x 150mm (H)

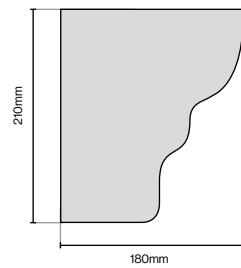

Shelf Bracket
180mm (L) x 37mm (W) 210mm (H)

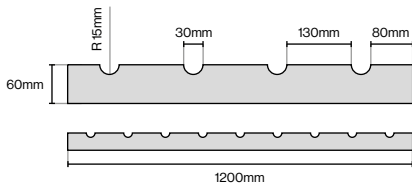

Wine Rack Rail
1200mm (L) x 18mm (W) x 60mm (H)

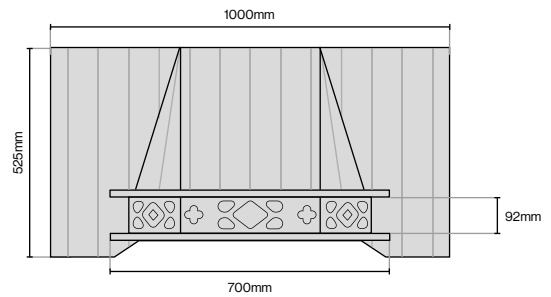

Traditional Canopy*
1000mm (L) x 193mm (D) x 525mm (H)

*Comes with fretwork and T&G detail as standard. If no detailing is required please specify when ordering.

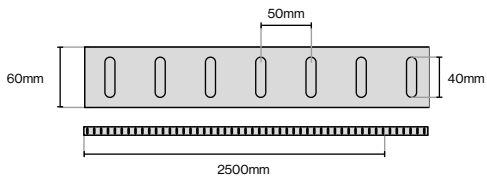

Fluted Rail
2500mm (L) x 18mm (W) x 60mm (H)

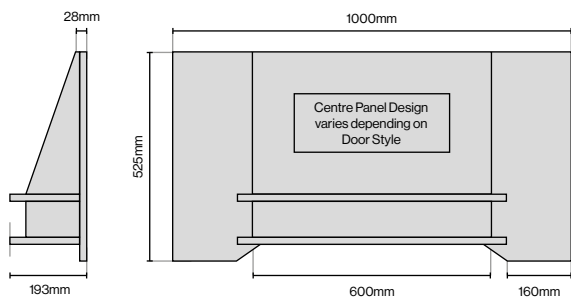

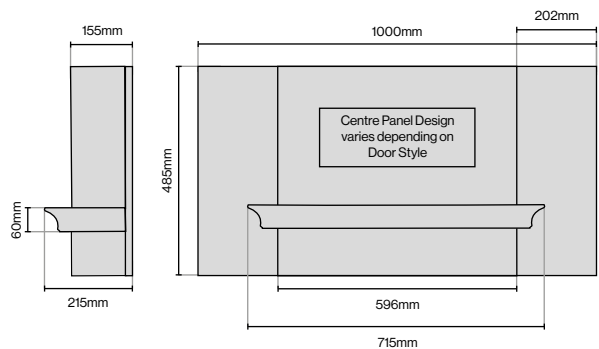

Modern Canopy
1000mm (L) x 193mm (D) x 525mm (H)



Classic Canopy
1000mm (W) x 215mm (D) x 485mm (H)

5G Vinyl | Bedroom Accessory Specifications

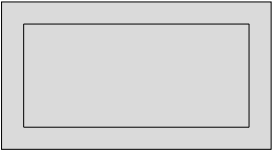
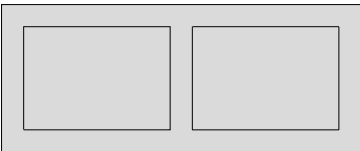
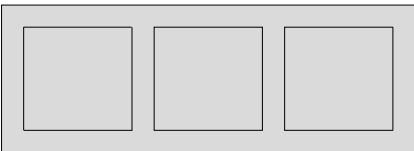
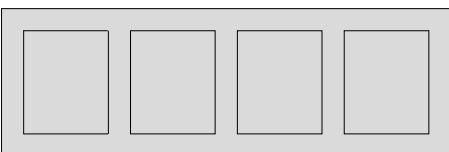
5G Headboard Specifications

Headboard Type		Height Range MM	Height Range MM
Single Panel		500mm – 900mm	915mm – 1830mm
2 Panel		500mm – 900mm	915mm – 1830mm
3 Panel		500mm – 900mm	1371mm – 1830mm
4 Panel		500mm – 900mm	1510mm – 1830mm
Flat Panel		500mm – 900mm	915mm – 1830mm

Headboards: All Headboards are supplied rectangular using the design of door style ordered.
 All Headboards will be supplied as Single Panels / Flat Panels (Applicable to Door Style) as standard, unless otherwise specified (Door Design permitting).

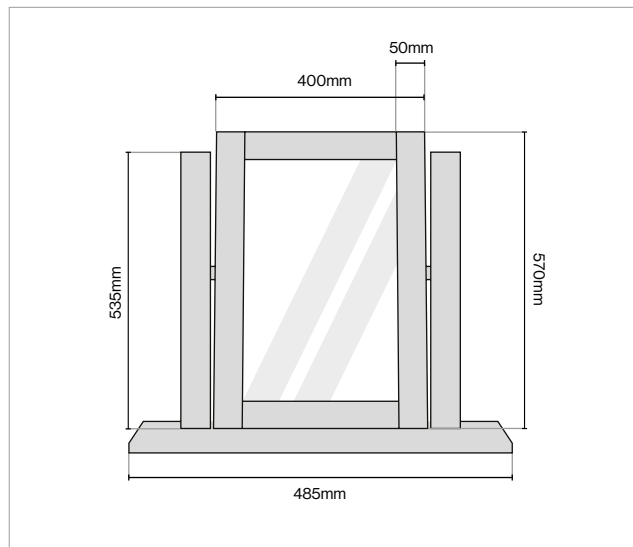



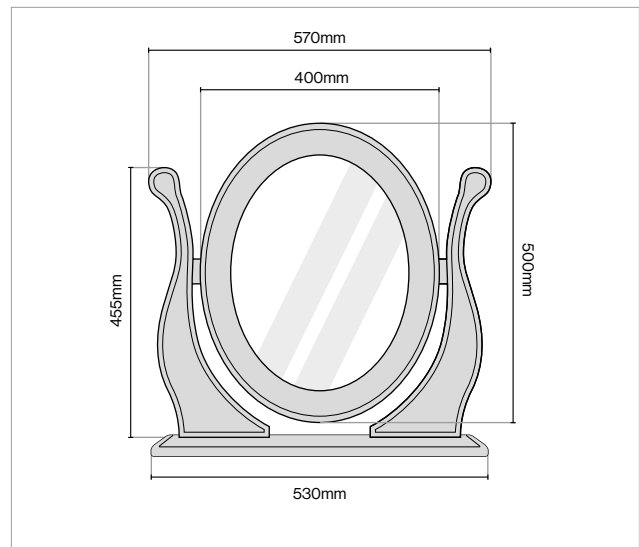

















Single Square Mirror: Single Square Mirrors are supplied fully assembled.





















Oval Mirror: Oval Mirrors are supplied fully assembled.

5G Vinyl | RAL Colour Match References























Matt Vinyl Finishes

O&S Doors Vinyl Colour	RAL Match
 Black	RAL 000 15 00
 Cashmere	RAL 060 80 05
 Cova Ivory	RAL 100 90 10
 Dakar	RAL 090 70 10
 Denim	RAL 250 70 10
 Dust Grey	RAL 000 60 00
 Evergreen	RAL 180 20 10
 Fjord	RAL 200 60 05
 Graphite	RAL 000 30 00
 Indigo	RAL 280 20 05
 Ivory	RAL 095 93 05
 Light Grey	RAL 7035
 Magnolia	RAL 085 90 10
 Meadow Green	RAL 140 70 05
 Mussel	RAL 085 85 10
 Porcelain	RAL 110 96 02
 Pure White	RAL 9003
 Stone Grey	RAL 060 60 05
 Taupe	RAL 090 85 05
 White Grey	RAL 000 90 00













Superior Matt Vinyl

O&S Doors Vinyl Colour	RAL Match
 Superior Matt Alabaster	RAL 090 90 05
 Superior Matt Black	RAL 000 15 00
 Superior Matt Cashmere	RAL 080 80 05
 Superior Matt Denim	RAL 250 70 10
 Superior Matt Dust Grey	RAL 000 65 00
 Superior Matt Graphite	RAL 000 35 00
 Superior Matt Heritage Green	RAL 180 40 05
 Superior Matt Indigo	RAL 280 20 05
 Superior Matt Antique Rose	RAL 040 60 10
 Superior Matt Light Gey	RAL 000 80 00
 Superior Matt Marine Blue	RAL 260 20 15
 Superior Matt Pebble	RAL 080 70 05
 Superior Matt Porcelain	RAL 060 60 05
 Superior Matt Reed Green	RAL 9003
 Superior Matt Stone Grey	RAL 060 60 05
 Superior Matt Taupe	RAL 080 80 05
 Superior Matt Tuscan Red	RAL 3009
 Superior Matt White Grey	RAL 000 90 00

Gloss Vinyl Finishes

O&S Doors Vinyl Colour	RAL Match
 Gloss Aubergine	RAL 350 20 15
 Gloss Black	RAL 000 15 00
 Gloss Cappuccino	RAL 060 60 10
 Gloss Cashmere	RAL 080 80 05
 Gloss Cream	RAL 085 90 10
 Gloss Dakar	RAL 090 70 10
 Gloss Denim	RAL 250 70 10
 Gloss Dust Grey	RAL 000 60 00
 Gloss Heritage Green	RAL 180 40 05
 Gloss Graphite	RAL 000 35 00
 Gloss Ivory	RAL 090 90 05
 Gloss Latte	RAL 075 80 10
 Gloss Light Grey	RAL 7035
 Gloss Mussel	RAL 090 85 05
 Gloss Marine Blue	RAL 260 20 15
 Gloss Metallic Anthracite	RAL N/A
 Gloss Oyster	RAL 090 93 05
 Glass Slate	RAL 080 30 05
 Gloss Red	RAL 030 30 45
 Gloss Stone Grey	RAL 060 60 05
 Gloss White	RAL 9003
 Gloss White Grey	RAL 000 90 00

Legno Vinyl Finishes

O&S Doors Vinyl Colour	RAL Match
 Legno Black	RAL 000 15 00
 Legno Cashmere	RAL 080 80 05
 Legno Dakar	RAL 090 70 10
 Legno Dust Grey	RAL 000 60 00
 Legno Evergreen	RAL 180 20 10
 Legno Graphite	RAL 000 30 00
 Legno Indigo	RAL 280 20 05
 Legno Ivory	RAL 095 93 05
 Legno Light Grey	RAL 000 80 00
 Legno Marine Blue	RAL 260 20 15
 Legno Mussel	RAL 095 85 10
 Legno Reed	RAL 160 60 05
 Legno Stone Grey	RAL 060 60 05
 Legno Taupe	RAL 090 85 05
 Legno White	RAL 9003
 Legno White Grey	RAL 000 90 00

Important Notice:

These RAL Colour match references are suggested options only. They are the closest RAL colour match to our vinyl colour, but please note they are not exact matches. Customers are strongly advised to obtain swatch samples to confirm a satisfactory colour match.

The listed RAL Colour matches are correct at time of printing. Due to unforeseen changes to the supply chain O&S Doors Ltd reserve the right due to amend, alter or discontinue finishes without prior notice.

5G Vinyl | Board Match Specifications

5G Vinyl | MTM

MDF Board Match References		Recommended MFC Board Match References				
Vinyl Colour	Matched Reverse (18mm MDF)	Egger	Kronospan	Pfleiderer	Finsa	Sonae
Acacia	Yes	H1277 ST9	D8975	-	Majestic S.3	-
Avola White	No	H1474 ST22	-	-	-	-
Avola Grey	No	H1484 ST22	-	-	-	-
Beech	Yes	H1582 ST15	1639 BS	R5542 VV	45A	M3582
Ontario Maple	No	H1869 ST9	-	R5479 VV	77C	M911
Dark Walnut	Yes	H3704 ST15	0481 BS	R4889 VV	10C	M3846
Halifax Natural Oak	Yes	H1180 ST37*	-	-	-	-
Halifax White Oak	Yes	H1176 ST37*	-	-	-	-
Light Oak	No	H1319 ST12	-	-	-	-
Lissa Oak	Yes	H1154 ST15*	8925 BS	R4276 VV	49D	M3851
Medium Walnut	Yes	H3703 ST15	0726 BS	R4899 VV	94A	M3569
Montana Oak	No	H1342 ST12	1929 SU	-	Amberes Roble 358	M963
Pippy Oak	Yes	H1381 ST12*	9277 PR	R4241 VV	34C	M3542
Sonoma Oak	Yes	H1146 ST12*	8197 SN	R4285 RU	Cambrian Oak 7AB	-
Urban Oak	Yes	-	K005PW	-	-	-
Winchester Oak	No	H1381 ST12 / H3382 ST9	8932 SU	-	-	-
Light Concrete	No (Use Light Grey)	F275 ST22	-	-	-	-
Dark Concrete	No (Use Dust Grey)	F274 ST9	-	-	-	-
Legno Black	Yes (Smooth)	U999 ST19	-	-	-	-
Legno Cashmere	Yes (Smooth)	U702 ST19	5981 GC*	U12168 MO	Gris Coco 15R	-
Legno Dakar	Yes (Smooth)	U717 ST19	5984 GC	-	Duna S.3	-
Legno Dust Grey	Yes (Smooth)	-	0171 GC*	U12150 MO	Gris Tormenta S.3	-
Legno Evergreen	Yes (Smooth)	U699 ST19	-	-	-	-
Legno Graphite	Yes (Smooth)	U961 ST19*	0164 GC	U12018 MO / U12257 MP	Petroleo 188	-
Legno Indigo	Yes (Smooth)	U599 ST19	-	-	-	-
Legno Ivory	Yes (Smooth)	U104 ST19	7031 GC*	U11506 MO	Contempo Ivory 88V	L402
Legno Light Grey	Yes (Smooth)	U708 ST19	0112 GC	U12204 MO*	Natural Grey U12	-
Legno Marine Blue	Yes (Smooth)	-	-	-	Azul Nautico Grained*	-
Legno Mussel	Yes (Smooth)	U100 ST19	5982 GC*	U15331 MO	Gris Porrin 192	-
Legno Reed	Yes (Smooth)	U608 ST19	-	-	-	-
Legno Stone Grey	Yes (Smooth)	U727 ST19	K096 GC*	U16002 MO	Mineral Grey S.3	-
Legno Taupe	Yes (Smooth)	U750 ST19*	-	-	-	-
Legno White	Yes (Smooth)	W980 ST19	0101 GC	U11015 MO*	White 020	B020
Legno White Grey	Yes (Smooth)	U775 ST19*	-	-	-	-
Black	Yes	U999 ST2	-	-	-	-
Cashmere	Yes	U702 ST9*	5981 PE	U12168 VV	Gris Coco 15R	-
Dakar	Yes	U717 ST9	5984 PE	U15190 VV	Duna S.3	-
Denim	Yes	U540 ST9*	-	-	Steel Blue S.3	-
Dust Grey	Yes	U732 ST9*	0171 PE	-	Gris Tormenta S.3	-
Evergreen	Yes	U699 ST9*	-	-	-	-
Fjord	Yes	U636 ST9	-	-	-	-
Graphite	Yes	U961 ST9	0164 PE	U12257 MP	Petroleo 188	-
Indigo	Yes	U599 ST9*	-	-	-	-
Ivory	Yes	U104 ST9*	0514 PE / 7031 PE	U1306	Contempo Ivory 88V	L402
Light Grey	Yes	U708 ST9*	0112 PE	U12204 MP	Gris Coco 15R	-
Magnolia	No (Use Ivory)	U108 ST9	9569 GC	U116	76B	-
Meadow Green	Yes	U608 ST9	-	-	-	-
Mussel	Yes	U100 ST9	5982 PE	U15331 VV	Gris Porrin 192	-
Paintable Vinyl	No (Use White)	-	-	-	-	-
Porcelain	No (Use White)	W1200 ST9*	0101 PE	W300 MP	White 020	-
Pure White	Yes	W1000 ST9* / W980 ST9*	0101 PE	U11015 VV	White 020	B020
Stone Grey	Yes	U727 ST9*	K096 SU	U16002 VV	Mineral Grey S.3	-
Taupe	Yes	U750 ST9*	-	-	-	-
White Grey	Yes	U775 ST9*	-	-	-	-

Matt Vinyl Finishes

5G Vinyl | Board Match Specifications

MDF Board Match References			Recommended MFC Board Match References				
Vinyl Colour	Matched Reverse (18mm MDF)		Egger	Kronospan	Pfleiderer	Finsa	Sonae
Superior Matt Vinyl Finishes	Superior Matt Alabaster	Yes*	U104 ST9*	0514 PE / 7031 PE	U11506 VV	Contempo Ivory 88V	L402
	Superior Matt Antique Rose	Yes*	U325 ST9	-	-	-	-
	Superior Matt Black	Yes*	U999 ST2	-	-	-	-
	Superior Matt Cashmere	Yes*	U702 ST9*	5981 PE	U12168 VV	Gris Coco 15R	-
	Superior Matt Denim	Yes*	U540 ST9*	-	-	Steel Blue S.3	-
	Superior Matt Dust Grey	Yes*	U732 ST9*	0171 PE	-	Gris Tormenta S.3	-
	Superior Matt Graphite	Yes*	U961 ST2	0164 PE	U12257 MP	Petroleo 188	-
	Superior Matt Heritage Green	Yes*	U699 ST9	-	-	-	-
	Superior Matt Indigo	Yes*	U599 ST9*	-	-	-	-
	Superior Matt Light Grey	Yes*	U708 ST9*	0112 PE	U12204 MP	Natural Grey U12	-
	Superior Matt Marine Blue	Yes*	-	-	-	Azul Nautico Smooth	-
	Superior Matt Porcelain	Yes*	W1200 ST9	-	-	-	-
	Superior Matt Pebble	Yes*	U201 ST9*	0101 PE	W300 MP	White 020	-
	Superior Matt Reed Green	Yes*	U604 ST9	2223BS	-	-	-
	Superior Matt Stone Grey	Yes*	U727 ST9*	K096 SU	U16002 VV	Mineral Grey S.3	-
	Superior Matt Taupe	Yes*	U750 ST9*	-	-	-	-
Superior Matt Tuscan Red	Yes*	U335 ST9	-	-	-	-	
Superior Matt White Grey	Yes*	U775 ST9*	-	-	-	-	
Gloss Vinyl Finishes	Gloss Aubergine	No (Use Matt White)	-	-	U17503 MP	-	-
	Gloss Black	Yes (Matt)	-	0190 PE	U12000 MP	231	-
	Gloss Cappuccino	No (Use Matt Ivory)	-	-	-	-	-
	Gloss Cashmere	Yes (Matt)	-	5981 PE	U12168 VV	Gris Coco 15R	-
	Gloss Cream	Yes (Matt)	-	0514 PE	U11509 VV	Contempo Ivory 88V	L402
	Gloss Dakar	Yes (Matt)	-	U5984 GC	U15190 VV	Duna S.3	-
	Gloss Denim	Yes (Matt)	-	-	-	Steel Blue S.3	-
	Gloss Dust Grey	Yes (Matt)	-	0171 PE	-	-	-
	Gloss Graphite	Yes (Matt)	-	0164 PE	U12257 MP	Petroleo 188	-
	Gloss Heritage Green	Yes (Matt)	U699 ST9	-	-	-	-
	Gloss Ivory	Yes (Matt)	U104 ST30*	0564 PE	U11506 VV	Contempo Ivory 88V	-
	Gloss Latte	No (Use Matt Ivory)	-	7045 SU	U1343 VV	-	-
	Gloss Light Grey	Yes (Matt)	-	0112 PE	U12204 MP	Natural Grey U12	-
	Gloss Marine Blue	Yes (Matt)	-	-	-	Azul Nautico Smooth*	-
	Gloss Metallic Anthracite	No (Matt Graphite)	U961 ST2	0164 PE	U12257 MP	Petroleo 188	-
	Gloss Mussel	Yes (Matt)	-	5982 PE	U15331 VV	Gris Porrin 192	-
	Gloss Oyster	No (Use Matt Ivory)	U104 ST30*	0564 PE	U11509 VV	Contempo Ivory 88V	-
	Gloss Red	No (Matt)	-	-	-	Rojo Red S.3 172	-
	Gloss Slate	Yes (Matt)	-	-	-	-	-
	Gloss Stone Grey	Yes (Matt)	-	K096 SU	U16002 VV	Mineral Grey S.3	-
	Gloss White	Yes (Matt)	W1000 ST30*	0101 PE	U11015 VV	White 020	B020
Gloss White Grey	Yes (Matt)	-	-	-	-	-	

22mm Door Reverse Colour - Available in White or Ivory. Please note if reverse colour is unspecified, Silver reverse will be used as default.

All MFC Board Matches marked in bold are available from O&S Doors Ltd.

*All Superior Matt matching backs are a colour match only. They do not have a super smooth matt laminate effect finish.

Important Notice: These board match references are only suggested options. Customers are strongly advised to obtain samples from their board or cabinet supplier in order to confirm a satisfactory match between the cabinet MFC and PVC door finish.

O&S Doors Ltd do not accept responsibility for any subsequent dissatisfaction between the board and door match. The listed PVC Finishes and board matches are correct at time of printing. Due to unforeseen changes in the supply chain O&S Doors Ltd reserve the right due to amend, alter or discontinue finishes and reverse boards without prior notice. If a match is of the essence a sample should always be sought first for final approval.

We recommend Pressed or Laminated Panels for the closest match.

Durable Construction. Handmade Aesthetic. Beautifully Designed. **Choose 5Piece.**

5Piece doors offer the traditional, handmade aesthetic that your customers want, with the added benefits of extra durability and flexibility of design through a wide choice of styles and finishes.

Within our 5Piece Collection we offer four beautifully designed, shaker style doors, that are each unique in their own right. Whether your customer prefers a classic or more contemporary style, each range is a blank canvas for you to add your own personal touch.



Harlem
8 Legno Finishes
1 Woodgrain Finish
See Page 56



Dylan
5 Matt Finishes
See Page 62



Fenwick
8 Legno Finishes
See Page 68



Bastille
7 Legno Finishes
See Page 76



Harlem | Kitchen Door Sizes

5 Piece | Ex:Stock and MTO

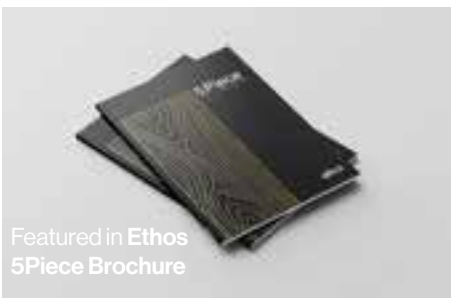

Door Specification

Description	5Piece Shaker Style Door with 60mm Stiles
Finish	Wrapped in Legno Embossed Grain Vinyl
Door Thickness	22mm Thick
Base Material	MDF Core
Special Features	Embossed Grain Vinyl Provides Extra Durability
Edge	1mm ABS End Caps and Chamfered Edges



8 Ex:Stock
Legno Finishes



Uni-Colour
Vinyl



Durable
Design



Embossed
Grain Texture



Urban Oak Finish
Available
Made To Order



Harlem | Colours / Finishes



The Harlem Door has been designed with a 60mm stile width to capture the growing trend for narrower Shaker styles. The centre panel is recessed at just 4.5mm to capture the growing trend for a shallow recess on Shaker style doors. The centre panel will be 12mm thick to achieve a very sturdy and robust door construction.

Note - Colour swatches shown are approximate. Please use Colour Swatch Book for a true colour match.

Harlem | Door and Drawer Sizes

Kitchen Door Sizes			Bedroom Door Sizes			Handleless Rail System Door Sizes						
Doors and Drawer Sizes	EXS	Curved Door Sizes	MTM	Doors and Drawer Sizes	MTM	Curved Door Sizes	MTM	Kitchen Door Sizes	MTM	Bedroom Door Sizes	MTM	
115X596	570X496	715 x 300		215 x 296	2150 x 346	1495 x 300		160 x 296		1400 x 263	1500 x 581	2250 x 563
140X296	570X596	895 x 300		215 x 396	2150 x 396	1595 x 300		160 x 396		1400 x 281	2150 x 263	2250 x 581
140X396	715X146	1245 x 300		215 x 446	2150 x 446	2150 x 300		160 x 446		1400 x 313	2150 x 281	
140X446	715X246	1965 x 300		215 x 496	2150 x 496	2250 x 300		160 x 496		1400 x 331	2150 x 313	
140X496	715X256			215 x 596	2150 x 596			160 x 596		1400 x 363	2150 x 331	
140X596	715X296			215 x 796	2250 x 296			160 x 796		1400 x 381	2150 x 363	
140X796	715X313			215 x 896	2250 x 346			160 x 896		1400 x 413	2150 x 381	
140X896	715X346			215 x 996	2250 x 396			160 x 996		1400 x 431	2150 x 413	
140X996	715X396			415 x 396	2250 x 446			325 x 496		1400 x 463	2150 x 431	
175X396	715X446			415 x 446	2250 x 496			325 x 596		1400 x 481	2150 x 463	
175X496	715X496			415 x 496	2250 x 596			325 x 796		1400 x 513	2150 x 481	
175X596	715X546	715X396 (Glazed)		515 x 396		1495 x 496 (Unglazed)		325 x 896		1400 x 531	2150 x 513	
283X496	715X596	895X396 (Glazed)		515 x 446		1595 x 396 (Unglazed)		325 x 996		1400 x 563	2150 x 531	
283X596	895X296	895X496 (Glazed)		515 x 496		1595 x 496 (Unglazed)		490 x 296		1400 x 581	2150 x 563	
283X796	895X396	1060X396 (Glazed)		650 x 396		2150 x 396 (Unglazed)		490 x 396		1500 x 263	2150 x 581	
283X896	895X446	1060X496 (Glazed)		650 x 446		2150 x 496 (Unglazed)		490 x 446		1500 x 281	2250 x 263	
283X996	895X496	1060X596 (Glazed)		650 x 496		2250 x 396 (Unglazed)		490 x 496		1500 x 313	2250 x 281	
355X496	895X596			1495 x 396		2250 x 496 (Unglazed)		490 x 596		1500 x 331	2250 x 313	
355X596	980X596			1495 x 446				685 x 146		1500 x 363	2250 x 331	
355X796	1060X396			1495 x 496				685 x 296		1500 x 381	2250 x 363	
355X896	1060X496			1595 x 396				685 x 315		1500 x 413	2250 x 381	
355X996	1060X596			1595 x 446				685 x 346		1500 x 431	2250 x 413	
450X596	1245X296			1595 x 496				685 x 396		1500 x 463	2250 x 431	
500X596	1245X396			1730 x 396				685 x 446		1500 x 481	2250 x 463	
570X296	1245X496			1730 x 446				685 x 496		1500 x 513	2250 x 481	
570X396	1245X596			1730 x 496				685 x 596		1500 x 531	2250 x 513	
570X446				2150 x 296						1500 x 563	2250 x 531	

Non-Standard Kitchen Door Sizes - Priced next door size up plus 40%.

Non-Standard Curved Kitchen Door Sizes - Priced next size up.

Curved Kitchen Doors available any height up to 2250mm

Concave Kitchen Doors are not available.

5Piece Curved Kitchen Door Specifications - See page 84.

All Standard Kitchen Plain Frame Sizes are supplied Glazed.

Non-Standard Kitchen Plain Frame Sizes are supplied Unglazed.

Non-Standard Kitchen Frame Sizes - Priced next door size up plus 40%.

MTM Frames - Supplied as individual pieces and require manual assembly.

Non-Standard Bedroom Door Sizes - Priced next door size up plus 40%.

Non-Standard Curved Bedroom Door Sizes - Priced next size up.

Curved Bedroom Doors available any height up to 2250mm

Concave Bedroom Doors are not available.

5Piece Curved Bedroom Door Specifications - See page 84.

All Bedroom Frame Sizes are supplied Unglazed.

Top Open Frames are not available.

Non-Standard Bedroom Frame Sizes - Priced next door size up plus 40%.

MTM Frames - Supplied as individual pieces and require manual assembly.

Drilling - Additional charge per hole.

EXS Available Ex.Stock. Ready for 48h despatch.

MTM Available Made to Measure. Ready for despatch in 5 working days.

Harlem | Door Specifications

5 Piece | Ex:Stock and MTO

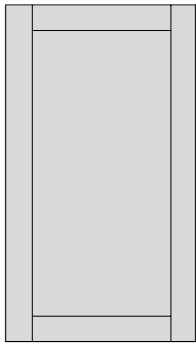

Harlem Kitchen Door

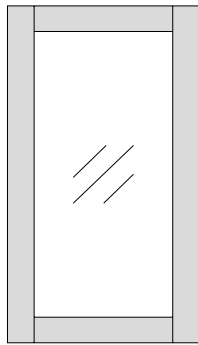

Harlem Kitchen Glazed Frame

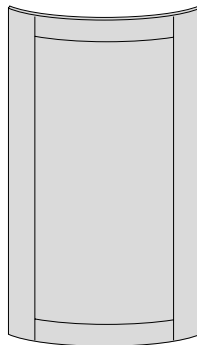

Harlem Kitchen Curved Door



Harlem Drawer

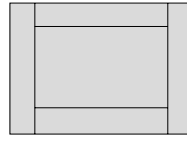

Harlem Pan Drawer

Harlem Kitchen Doors:

Kitchen Door sizes between 356 - 2400mm high are supplied 5-piece as standard. Minimum Door width is 246mm.

Harlem Drawers:

Drawer sizes between 100 - 215mm high are supplied as 1-piece flat panels (See Drawer visual for reference).

Minimum Drawer width 246mm.

Pan Drawer sizes between 283 - 355mm high are supplied as 5-piece. Minimum Pan Drawer width 246mm.

It's important to specify either Door, Drawer or Pan Drawer when ordering to ensure your order is processed correctly.

Harlem Frames:

Ex:Stock Frame sizes are supplied glazed. Top Open Frames are available. Non-Standard Frame sizes are available unglazed.

Harlem Bedroom Doors:

Bedroom Door sizes between 1735 - 2400mm high are supplied 5-piece as standard. Minimum Door width is 246mm.

Harlem Curved Doors:

Curved Doors are made to suit 300 x 300mm cabinets only. Height availability ranges from 715mm up to 2250mm. Concave Doors are not available. Non-Standard Curved Door sizes are not available.

Drilling:

All Doors are supplied un-drilled unless requested by the customer. If drilling is required, then drilling instructions must be clearly stated along with full dimensions for all holes required.

Angled Doors are not available.

Non-Standard Bedroom Door Sizes - Priced next door size up plus 40%.

Drilling - Additional charge per hole.

Non-Standard Curved Bedroom Door Sizes - Priced next size up.

Curved Bedroom Doors available any height up to 2250mm.

Concave Bedroom Doors are not available.

Curved Bedroom Door Specifications - See page 84.

All Bedroom Frame Sizes are supplied Unglazed. Top Open Frames are available.

Non-Standard Bedroom Frame Sizes - Priced next door size up plus 40%.

MTM Frames - Supplied as individual pieces and require manual assembly.

Panelled Bedroom Doors - Bedroom Door sizes between 1735mm - 2400mm high are supplied as single panels with one separate 75mm mid-rail as standard. The mid-rail must then be attached manually during installation. For Panelled Bedroom Doors you must clearly state 3, 4 or 5 panels when ordering to ensure the extra 60mm mid-rail pieces are included with your order.

Extra Mid-Rails - Additional charge per Mid-Rail.

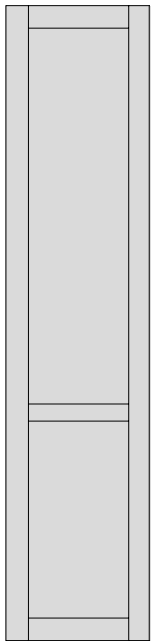

Harlem Bedroom Standard 2 Panel Door

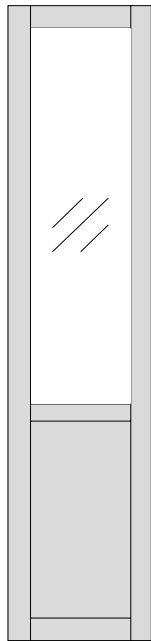

Harlem Bedroom Top Open Frame

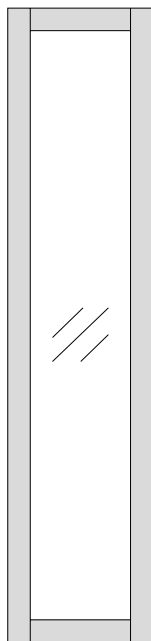

Harlem Bedroom Full Open Frame

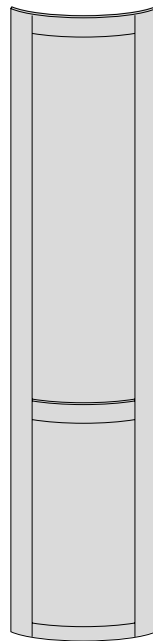

Harlem Bedroom Curved Door

SPLIT DIMENSIONS

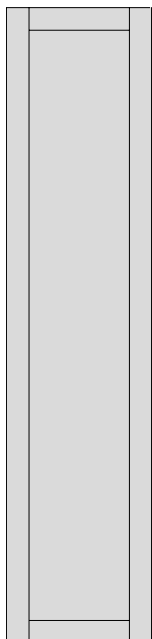

Harlem Bedroom Single Panel Door
No mid-rails included*

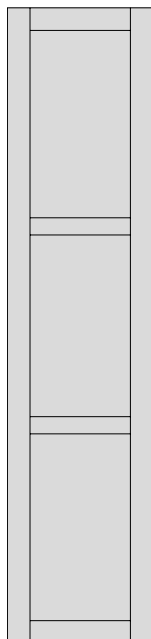

Harlem Bedroom 3 Panel Door
Includes 2 separate mid-rail pieces*

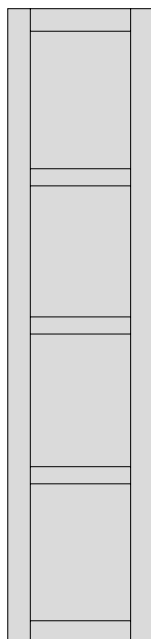

Harlem Bedroom 4 Panel Door
Includes 3 separate mid-rail pieces*

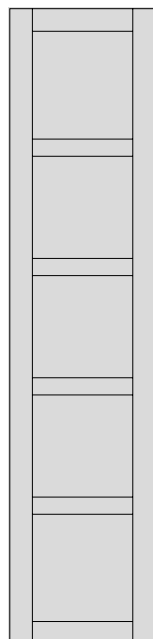

Harlem Bedroom 5 Panel Door
Includes 4 separate mid-rail pieces*

Harlem Door Cross Section

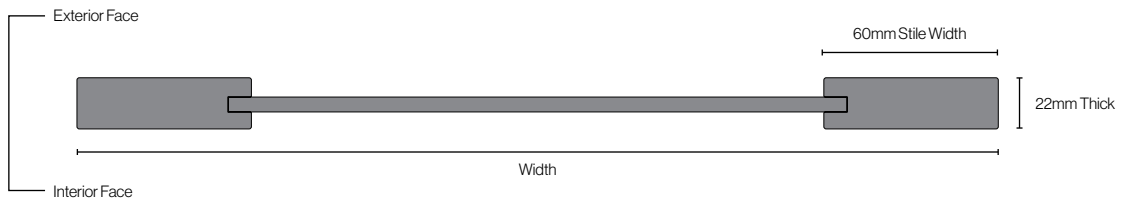

Harlem Door Cross Section

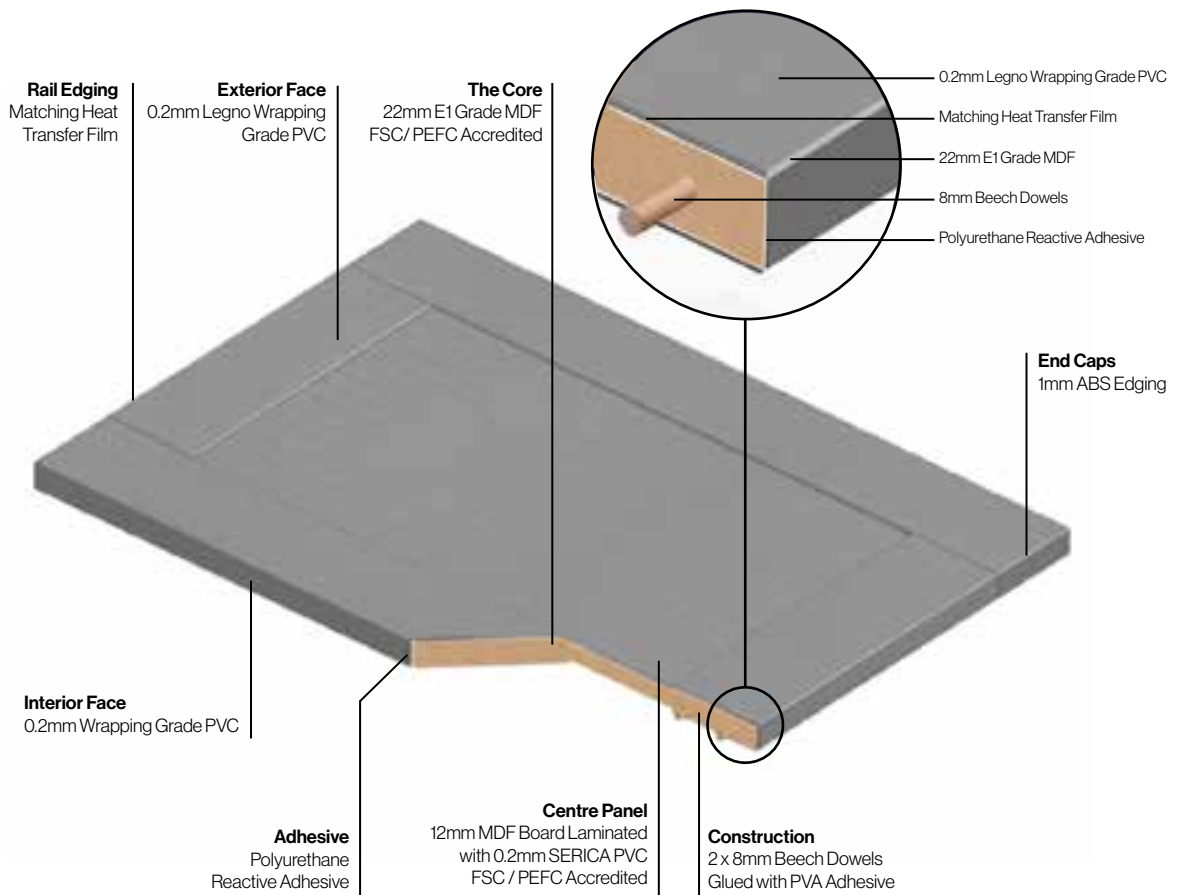
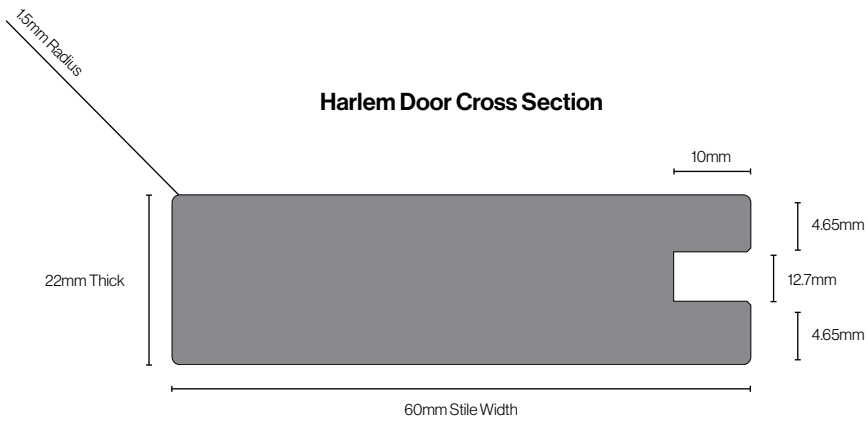

Harlem | Accessories

5 Piece | Ex:Stock and MTO

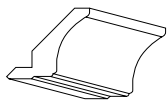

Classic Cornice
76mm (W) x 63mm (H)
3050mm Lengths

EXS

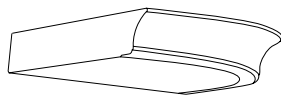

Curved Classic Cornice
364mm (L) x 364mm (W)
x 63mm (H)

MTM

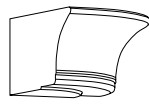

Classic Cornice Quadrant
84mm (L) x 84mm (W)
x 63mm (H)

MTM

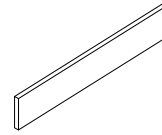

Plain Plinth
18mm (W) x 150mm (H)
3050mm Lengths

EXS



Curved Plain Plinth
300mm (L) x 300mm (W)
x 150mm (H)

MTM

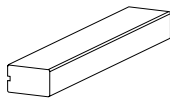

Modern Cornice / Pelmet
50mm (W) x 30mm (H)
3050mm Lengths

EXS

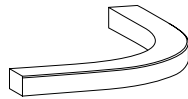

Curved Modern Cornice / Pelmet
350mm (L) x 350mm (W)
x 30mm (H)

MTM

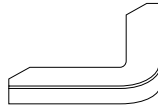

Modern Cornice / Pelmet Quadrant
220mm (L) x 220mm (W)
x 30mm (H)

MTM

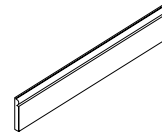

Torus Plinth
18mm (W) x 150mm (H)
3050mm Lengths

MTM



Curved Torus Plinth
300mm (L) x 300mm (W)
x 150mm (H)

MTM

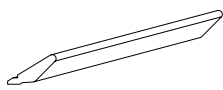

Tangent Cornice
72mm (W) x 44mm (H)
3050mm Lengths

EXS

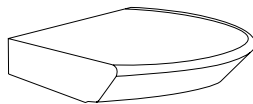

Curved Tangent Cornice
400mm (L) x 400mm (W)
x 44mm (H)

MTM



Tangent Cornice Quadrant
88mm (L) x 88mm (W)
x 44mm (H)

MTM

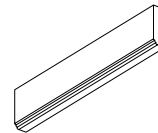

Tangent Pelmet
18mm (W) x 57mm (H)
3050mm Lengths

EXS

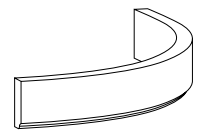

Curved Tangent Pelmet
300mm (L) x 300mm (W)
x 57mm (H)

MTM

Not available in Marine Blue



MTM Corner Post
715mm (150 x 150mm Max)

MTM

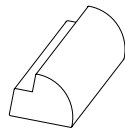

Radius Profile (R 48mm)
70mm (W) x 50mm (H)
3050mm Lengths

EXS

Limited Finishes. See Page 46.

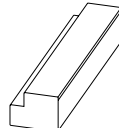

Square Base Pilaster
70mm (W) x 50mm (H)
3050mm Lengths

EXS

Limited Finishes. See Page 46.

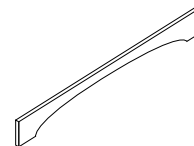

Arched Pelmet
2400mm (L) x 18mm (W)
x 200mm (H)

MTM

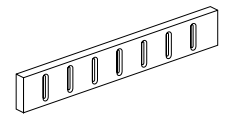

Fluted Rail
18mm (W) x 60mm (H)
2500mm Lengths

MTM



Plain Pilaster
100mm (W) x 900mm (H)
MTM up to 2500mm

MTM



Fluted Pilaster
100mm (W) x 900mm (H)
MTM up to 2500mm

MTM



Special Pilaster
100mm (W) x 900mm (H)
MTM up to 2500mm

MTM

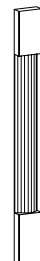

Reeded Pilaster
100mm (W) x 900mm (H)
MTM up to 2500mm

MTM



Gun Barrel Pilaster
90mm (W) x 900mm (H)
90mm (W) x 1250 (H)
94mm (W) x 2150 (H)

EXS



Roman Reed Pilaster
90mm (W) x 900mm (H)
90mm/94mm (W) x 1250 (H)
94mm (W) x 2150 (H)

EXS

Harlem | Accessories

5 Piece | Ex:Stock and MTO

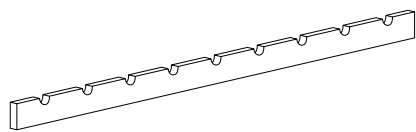

Wine Rack Rail
1200mm (L) x 18mm (W)
x 60mm (H)

MTM

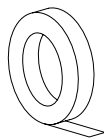

Pre-Glued Edging Tape
50m Roll.

EXS

Not available in Legno Marine Blue,
Legno Taupe and Legno White Grey

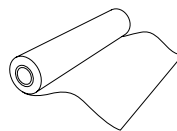

Peel 'n' Stick
Per m2

EXS

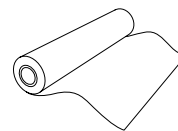

Vinyl
Per m2

EXS



Shelf Bracket
180mm (D) x 37mm (W)
x 210mm (H)

MTM

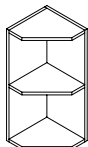

Wall Quad / Base Quad
MTM

MTM

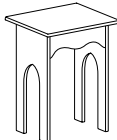

Stool
400mm (L) x 350mm (W)
x 470mm (H)

MTM

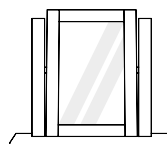

Single Square Mirror
485mm (W) x 570mm (H)

MTM

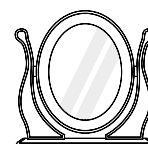

Single Oval Mirror
485mm (W) x 570mm (H)

MTM

See page 88 for all full mirror dimensions



Pressed Plain Panel
18mm Thick

Standard Sizes MM:
785 x 360mm
900 x 650mm
900 x 1200mm
965 x 360mm
2400 x 360mm
2400 x 650mm

Made to Measure per m2

MTM

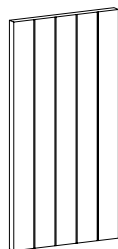

Pressed T&G Panel
18mm Thick

Standard Sizes MM:
785 x 360mm
900 x 650mm
900 x 1200mm
965 x 360mm
2400 x 360mm
2400 x 650mm

Made to Measure per m2

MTM



Flat Laminated Panel
18mm Thick

Standard Size MM:
785X360
900X650
965X360
2400X650

EXS

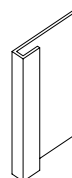

Return Gable
Made to Measure per m2
See page 222 for Order Form

MTM

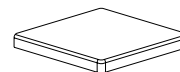

Moulded Top
Made to Measure per m2

MTM

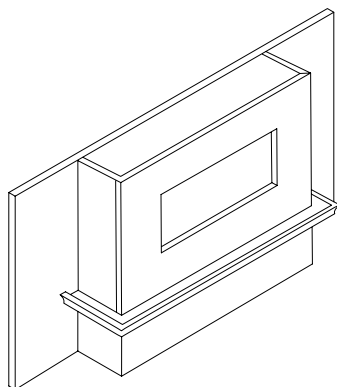

Classic Canopy
1000mm (W) x 215mm (D) x 485mm (H)

MTM

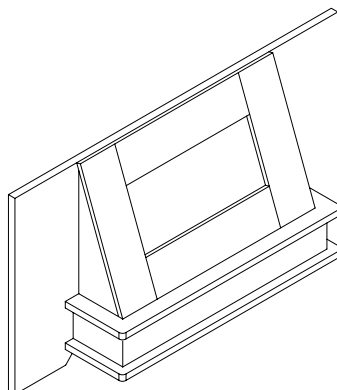

Modern Canopy
1000mm (L) x 193mm (D) x 525mm (H)

MTM

EXS

Available Ex:Stock (Limited Finishes).
Ready for 48h despatch.

MTM

Available Made to Measure.
Ready for despatch in 5 working days.

Dylan | Kitchen Door Sizes

5 Piece | Ex:Stock and MTO



Door Specification

Description	5Piece Shaker Style Door with 75mm Stiles
Finish	Wrapped in Matt Vinyl
Door Thickness	22mm Thick
Base Material	MDF Core
Special Features	Subtile Matt Microtexture Vinyl
Edge	1mm ABS End Caps and Chamfered Edges



5 Ex:Stock
Matt Finishes



Micro
Texture



Durable
Design



Featured in Ethos
5Piece Brochure



Dylan | Colours / Finishes

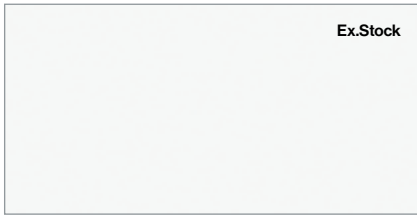

Matt White Grey



Matt Light Grey



Matt Dust Grey



Matt Taupe



Matt Indigo

The Dylan door has only been with us for a short time as a more durable replacement for Loxley and there are no plans to add additional colours at present.

Note - Colour swatches shown are approximate. Please use Colour Swatch Book for a true colour match.

Dylan | Door and Drawer Sizes

Kitchen Door Sizes			Bedroom Door Sizes			Handleless Rail System Door Sizes						
Doors and Drawer Sizes	EXS	Curved Door Sizes	MTM	Doors and Drawer Sizes	MTM	Curved Door Sizes	MTM	Kitchen Door Sizes	MTM	Bedroom Door Sizes	MTM	
115X596	570X496	715 x 300		215 x 296	2150 x 296	1495 x 300		160 x 296		1400 x 263	1500 x 563	2250 x 513
140X296	570X596	895 x 300		215 x 396	2150 x 346	1595 x 300		160 x 396		1400 x 281	1500 x 581	2250 x 531
140X396	715X146	1245 x 300		215 x 446	2150 x 396	2150 x 300		160 x 446		1400 x 313	2150 x 263	2250 x 563
140X446	715X246	1965 x 300		215 x 496	2150 x 446	2250 x 300		160 x 496		1400 x 331	2150 x 281	2250 x 581
140X496	715X256			215 x 596	2150 x 496			160 x 596		1400 x 363	2150 x 313	
140X596	715X296			215 x 796	2150 x 596			160 x 796		1400 x 381	2150 x 331	
140X796	715X313			215 x 896	2250 x 296			160 x 896		1400 x 413	2150 x 363	
140X896	715X346			215 x 996	2250 x 346			160 x 996		1400 x 431	2150 x 381	
140X996	715X396	Plain Frames	EXS	415 x 396	2250 x 396	Full Open Frames	MTM	325 x 496		1400 x 463	2150 x 413	
175X396	715X446			415 x 446	2250 x 446	1495 x 396 (Unglazed)		325 x 596		1400 x 481	2150 x 431	
175X496	715X496	715X396 (Glazed)		415 x 496	2250 x 496	1495 x 496 (Unglazed)		325 x 796		1400 x 513	2150 x 463	
175X596	715X546	715X496 (Glazed)		515 x 396	2250 x 596	1595 x 396 (Unglazed)		325 x 896		1400 x 531	2150 x 481	
283X496	715X596	895X396 (Glazed)		515 x 446		1595 x 496 (Unglazed)		325 x 996		1400 x 563	2150 x 513	
283X596	895X296	895X496 (Glazed)		515 x 496		1595 x 596 (Unglazed)		490 x 296		1400 x 581	2150 x 531	
283X796	895X396	1060X396 (Glazed)		650 x 396		2150 x 396 (Unglazed)		490 x 396		1500 x 263	2150 x 563	
283X896	895X446	1060X496 (Glazed)		650 x 446		2150 x 496 (Unglazed)		490 x 446		1500 x 281	2150 x 581	
283X996	895X496	1060X596 (Glazed)		650 x 496		2250 x 396 (Unglazed)		490 x 496		1500 x 313	2250 x 263	
355X496	895X596			1495 x 396		2250 x 496 (Unglazed)		490 x 596		1500 x 331	2250 x 281	
355X596	980X596			1495 x 446				685 x 146		1500 x 363	2250 x 313	
355X796	1060X396			1495 x 496				685 x 296		1500 x 381	2250 x 331	
355X896	1060X496			1595 x 396				685 x 315		1500 x 413	2250 x 363	
355X996	1060X596			1595 x 446				685 x 346		1500 x 431	2250 x 381	
450X596	1245X296			1595 x 496				685 x 396		1500 x 463	2250 x 413	
500X596	1245X396			1730 x 396				685 x 446		1500 x 481	2250 x 431	
570X296	1245X496			1730 x 446				685 x 496		1500 x 513	2250 x 463	
570X396	1245X596			1730 x 496				685 x 596		1500 x 531	2250 x 481	

Non-Standard Kitchen Door Sizes - Priced next door size up plus 40%.

Non-Standard Curved Kitchen Door Sizes - Priced next size up.

Curved Kitchen Doors available any height up to 2250mm

Concave Kitchen Doors are not available.

5Piece Curved Kitchen Door Specifications - See page 84.

All Standard Kitchen Plain Frame Sizes are supplied Glazed.

Non-Standard Kitchen Plain Frame Sizes are supplied Unglazed.

Non-Standard Kitchen Frame Sizes - Priced next door size up plus 40%.

MTM Frames - Supplied as individual pieces and require manual assembly.

Non-Standard Bedroom Door Sizes - Priced next door size up plus 40%.

Non-Standard Curved Bedroom Door Sizes - Priced next size up.

Curved Bedroom Doors available any height up to 2250mm

Concave Bedroom Doors are not available.

5Piece Curved Bedroom Door Specifications - See page 84.

All Bedroom Frame Sizes are supplied Unglazed.

Top Open Frames are not available.

Non-Standard Bedroom Frame Sizes - Priced next door size up plus 40%.

MTM Frames - Supplied as individual pieces and require manual assembly.

Drilling - Additional charge per hole.

EXS Available Ex.Stock.
Ready for 48h despatch.

MTM Available Made to Measure.
Ready for despatch in 5 working days.

Dylan | Door Specifications

5 Piece | Ex:Stock and MTO

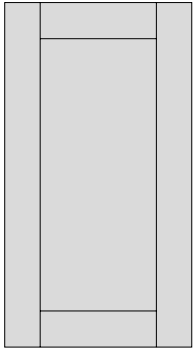

Dylan Kitchen Door

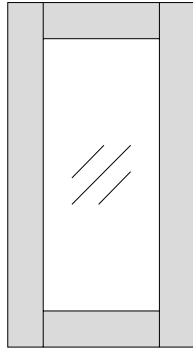

Dylan Kitchen Glazed Frame

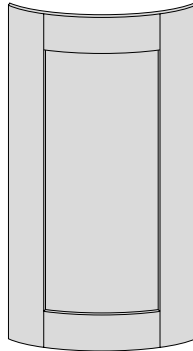

Dylan Kitchen Curved Door



Dylan Drawer

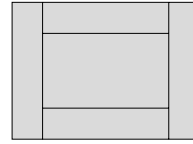

Dylan Pan Drawer

Dylan Kitchen Doors:

Kitchen Door sizes between 356 - 2400mm high are supplied 5-piece as standard. Minimum Door width is 246mm.

Dylan Drawers:

Drawer sizes between 100 - 215mm high are supplied as 1-piece flat panels (See Drawer visual for reference).

Minimum Drawer width 246mm.

Pan Drawer sizes between 283 - 355mm high are supplied as 5-piece. Minimum Pan Drawer width 246mm.

It's important to specify either Door, Drawer or Pan Drawer when ordering to ensure your order is processed correctly.

MTM Drawers are available.

Dylan Frames:

Ex:Stock Frame sizes are supplied glazed. Top Open Frames are available. Non-Standard Frame sizes are available. Minimum Frame width is 396mm supplied unglazed.

Dylan Curved Doors:

Curved Doors are made to suit 300 x 300mm cabinets only. Height availability ranges from 715mm up to 2250mm. Concave Doors are not available. Non-Standard Curved Door sizes are not available.

Drilling:

All Doors are supplied un-drilled unless requested by the customer. If drilling is required, then drilling instructions must be clearly stated along with full dimensions for all holes required.

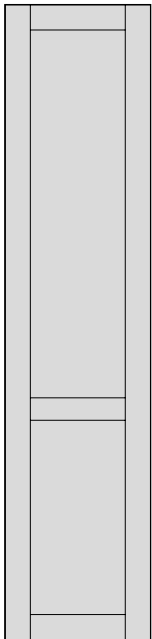

Dylan Bedroom Standard 2 Panel Door

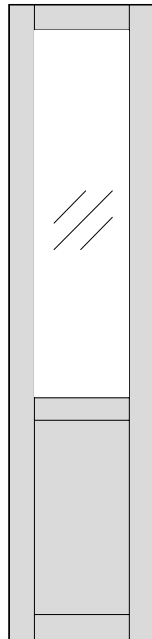

Dylan Bedroom Top Open Frame

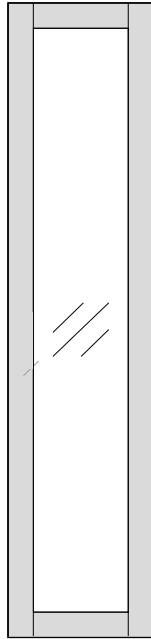

Dylan Bedroom Full Open Frame

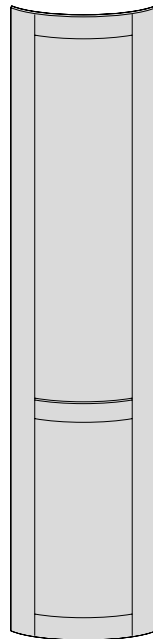

Dylan Bedroom Curved Door

SPLIT DIMENSIONS

Angled Doors and Frames are not available.

Non-Standard Bedroom Door Sizes - Priced next door size up plus 40%.

Drilling - Additional charge per hole.

Non-Standard Curved Bedroom Door Sizes - Priced next size up.

Curved Bedroom Doors available any height up to 2250mm

Concave Bedroom Doors are not available.

5 Piece Curved Bedroom Door Specifications - See page 84.

All Bedroom Frame Sizes are supplied Unglazed.

Top Open Frames are available.

Non-Standard Bedroom Frame Sizes - Priced next door size up plus 40%.

MTM Frames - Supplied as individual pieces and require manual assembly.

Panelled Bedroom Doors - Bedroom Door sizes between 1735mm - 2400mm high are supplied as single panels with one separate 75mm mid-rail as standard. The mid-rail must then be attached manually during installation. For Panelled Bedroom Doors you must clearly state 3, 4 or 5 panels when ordering to ensure the extra 75mm mid-rail pieces are included with your order.

Kitchen and Bedroom Matrix.

Drilling - Additional charge per hole.

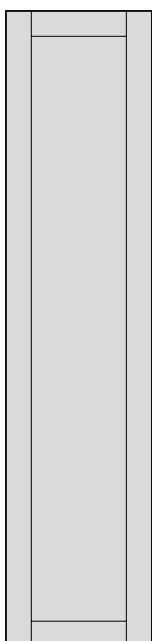

Dylan Bedroom Single Panel Door
No mid-rails included*

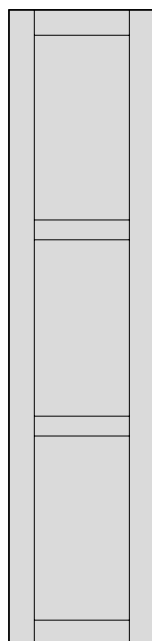

Dylan Bedroom 3 Panel Door
Includes 2 separate mid-rail pieces*

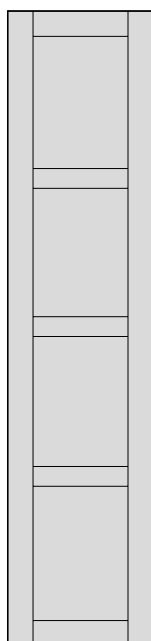

Dylan Bedroom 4 Panel Door
Includes 3 separate mid-rail pieces*

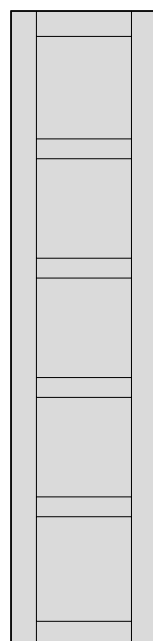

Dylan Bedroom 5 Panel Door
Includes 4 separate mid-rail pieces*

Dylan | Technical Specifications

Dylan Door Cross Section

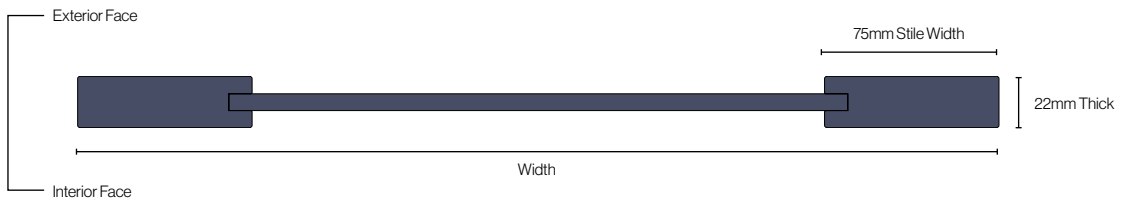

Dylan Stile Cross Section

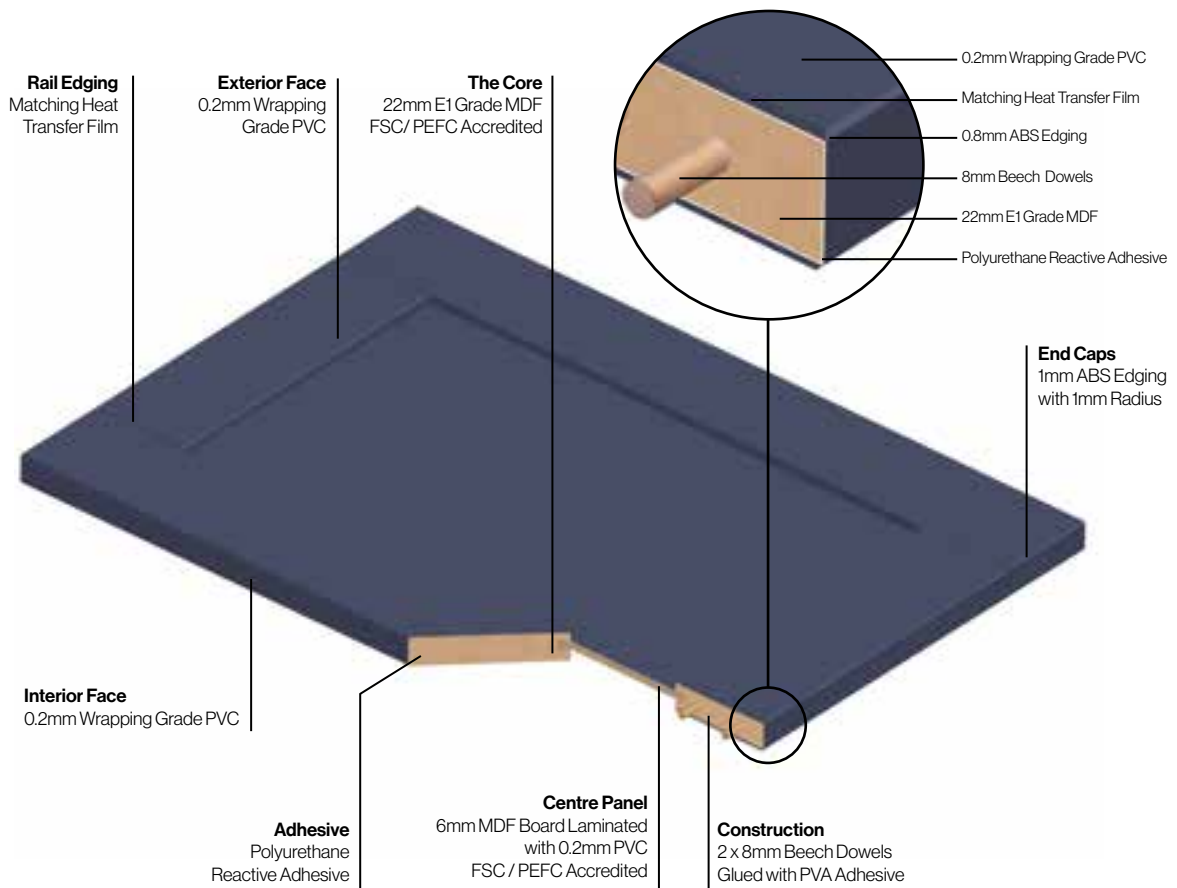
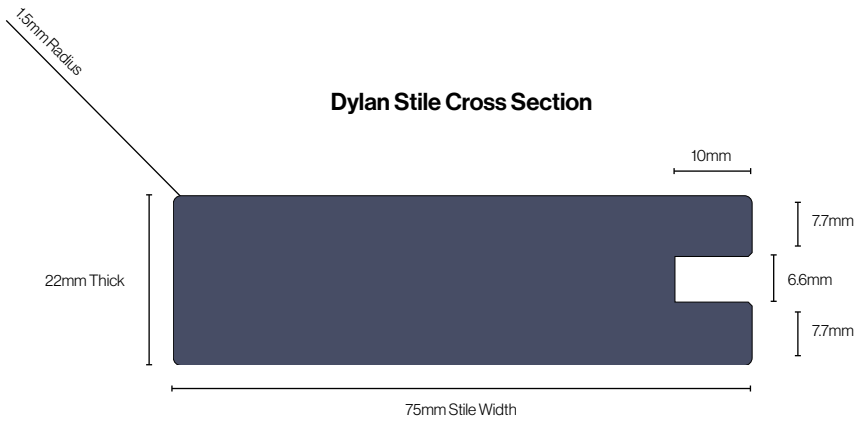

Dylan | Accessories

5 Piece | Ex:Stock and MTO

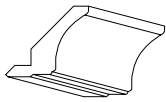

Classic Cornice
76mm (W) x 63mm (H)
3050mm Lengths

EXS

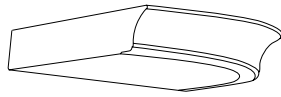

Curved Classic Cornice
364mm (L) x 364mm (W)
x 63mm (H)

MTM

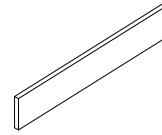

Plain Plinth
18mm (W) x 150mm (H)
3050mm Lengths

EXS

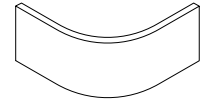

Curved Plain Plinth
300mm (L) x 300mm (W)
x 150mm (H)

MTM

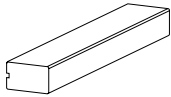

Modern Cornice / Pelmet
50mm (W) x 30mm (H)
3050mm Lengths

EXS

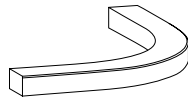

Curved Modern Cornice / Pelmet
350mm (L) x 350mm (W)
x 30mm (H)

MTM

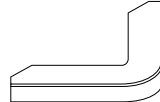

**Modern Cornice /
Pelmet Quadrant**
220mm (L) x 220mm (W)
x 30mm (H)

MTM

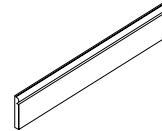

Torus Plinth
18mm (W) x 150mm (H)
3050mm Lengths

MTM



Curved Torus Plinth
300mm (L) x 300mm (W)
x 150mm (H)

MTM

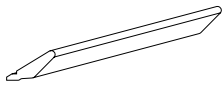

Tangent Cornice
72mm (W) x 44mm (H)
3050mm Lengths

EXS

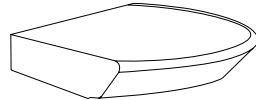

Curved Tangent Cornice
400mm (L) x 400mm (W)
x 44mm (H)

MTM

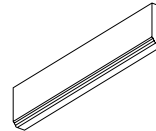

Tangent Pelmet
18mm (W) x 57mm (H)
3050mm Lengths

EXS

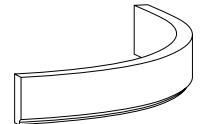

Curved Tangent Pelmet
300mm (L) x 300mm (W)
x 57mm (H)

MTM



MTM Corner Post
715mm (150 x 150mm Max)

MTM

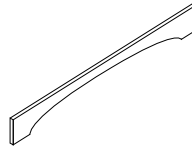

Arched Pelmet
2400mm (L) x 18mm (W)
x 200mm (H)

MTM

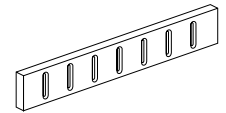

Fluted Rail
18mm (W) x 60mm (H)
2500mm Lengths

MTM

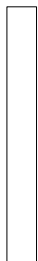

Plain Pilaster
100mm (W) x 900mm (H)
MTM up to 2500mm

MTM

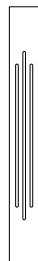

Fluted Pilaster
100mm (W) x 900mm (H)
MTM up to 2500mm

MTM



Special Pilaster
100mm (W) x 900mm (H)
MTM up to 2500mm

MTM



Reeded Pilaster
100mm (W) x 900mm (H)
MTM up to 2500mm

MTM



Gun Barrel Pilaster
90mm (W) x 900mm (H)
90mm (W) x 1250 (H)
94mm (W) x 2150 (H)

EXS



Roman Reed Pilaster
90mm (W) x 900mm (H)
90mm/94mm (W) x 1250 (H)
94mm (W) x 2150 (H)

EXS

Dylan | Accessories

5 Piece | Ex:Stock and MTO

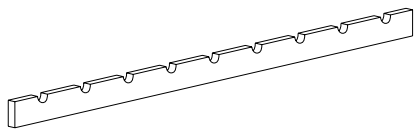

Wine Rack Rail
1200mm (L) x 18mm (W)
x 60mm (H)

MTM

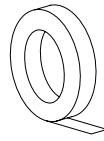

Pre-Glued Edging Tape
50m Roll.

EXS

Not available in Legno Marine Blue,
Legno Taupe and Legno White Grey

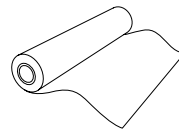

Peel 'n' Stick
Per m2

EXS

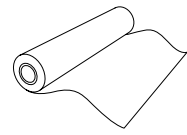

Vinyl
Per m2

EXS

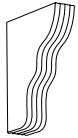

Shelf Bracket
180mm (D) x 37mm (W)
x 210mm (H)

MTM

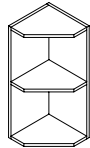

Wall Quad / Base Quad
MTM

MTM

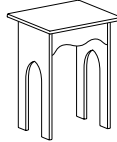

Stool
400mm (L) x 350mm (W)
x 470mm (H)

MTM

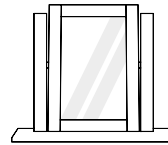

Single Square Mirror
485mm (W) x 570mm (H)

MTM

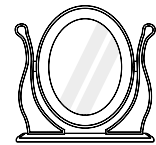

Single Oval Mirror
485mm (W) x 570mm (H)

MTM

See page 88 for all full mirror dimensions

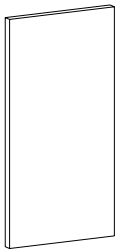

Pressed Plain Panel
18mm Thick

Standard Sizes MM:
785 x 360mm
900 x 650mm
900 x 1200mm
965 x 360mm
2400 x 360mm
2400 x 650mm

Made to Measure per m2

MTM

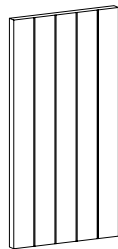

Pressed T&G Panel
18mm Thick

Standard Sizes MM:
785 x 360mm
900 x 650mm
900 x 1200mm
965 x 360mm
2400 x 360mm
2400 x 650mm

Made to Measure per m2

MTM



Flat Laminated Panel
18mm Thick

Standard Size MM:
785X360
900X650
965X360
2400X650

EXS

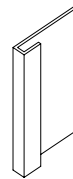

Return Gable
Made to Measure per m2
See page 222 for Order Form

MTM

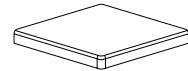

Moulded Top
Made to Measure per m2

MTM

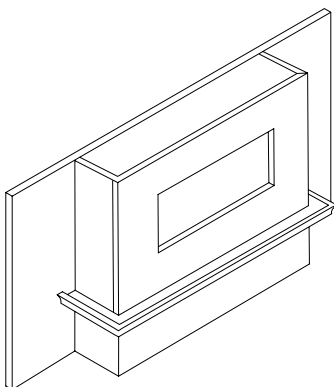

Classic Canopy
1000mm (W) x 215mm (D) x 485mm (H)

MTM

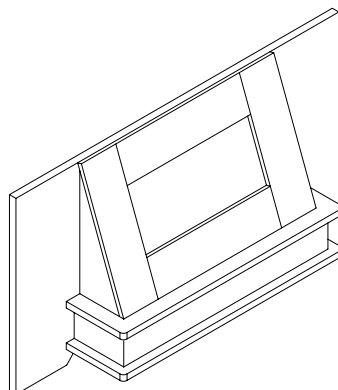

Modern Canopy
1000mm (L) x 193mm (D) x 525mm (H)

MTM

EXS

Available Ex:Stock (Limited Finishes).
Ready for 48h despatch.

MTM

Available Made to Measure.
Ready for despatch in 5 working days.

Fenwick | 5 Piece Collection

5 Piece | Ex:Stock and MTO



Door Specification

Description	5Piece Shaker Style Door with 105mm Stiles
Finish	Wrapped in Solid, Uni-Colour, Legno Grain Embossed Vinyl
Door Thickness	22mm Thick
Base Material	MDF Core
Special Features	Embossed Grain Vinyl Provides Extra Durability
Edge	2mm ABS End Caps and Chamfered Edges



8 Ex:Stock
Legno Finishes



Available
Made to Measure



Uni-Colour
Vinyl



Embossed
Texture



Durable
Construction



Featured in Ethos
5 Piece Brochure



Fenwick | Colours / Finishes



Legno White



Legno Ivory



Legno White Grey



Legno Taupe



Legno Light Grey



Legno Dust Grey



Legno Graphite



Legno Marine Blue

Note - Colour swatches shown are approximate. Please use Colour Swatch Book for a true colour match.

5 Piece | Ex.Stock and MTO



Available Ex.Stock (Limited Finishes).
Ready for 48h despatch.



Available Made to Measure.
Ready for despatch in 5 working days.

Fenwick | Door and Drawer Sizes

5 Piece | Ex:Stock and MTO



Kitchen Door Sizes				
Doors and Drawer Sizes		EXS	Curved Door Sizes	MTM
115X596	355X796	715X596	715 x 300	
140X296	355X896	895X296	895 x 300	
140X396	355X996	895X396	1245 x 300	
140X446	450X596	895X446	1965 x 300	
140X496	500X596	895X496		
140X596	570X296	895X596		
140X796	570X396	980X596		
140X896	570X446	1060X396		
140X996	570X496	1060X496		
175X396	570X596	1060X596		
175X496	715X146	1245X296		
175X596	715X246	1245X396		
283X496	715X256	1245X496		
283X596	715X296	1245X596		
283X796	715X313			
283X896	715X346			
283X996	715X396			
355X496	715X446			
355X596	715X496			
355X796	715X546			
			Plain Frames	EXS
			715 x 396 (Glazed)	
			715 x 496 (Glazed)	
			895 x 396 (Glazed)	
			895 x 496 (Glazed)	
			1060 x 396 (Glazed)	
			1060 x 496 (Glazed)	
			1060 x 596 (Glazed)	

Bedroom Door Sizes				
Doors and Drawer Sizes		EXS	Curved Door Sizes	MTM
215 x 296	1595 x 396		1495 x 300	
215 x 396	1595 x 446		1595 x 300	
215 x 446	1595 x 496		2150 x 300	
215 x 496	1730 x 396		2250 x 300	
215 x 596	1730 x 446			
215 x 796	1730 x 496			
215 x 896	2150 x 296			
215 x 996	2150 x 346			
415 x 396	2150 x 396			
415 x 446	2150 x 446			
415 x 496	2150 x 496			
515 x 396	2150 x 596			
515 x 446	2250 x 296			
515 x 496	2250 x 346			
650 x 396	2250 x 396			
650 x 446	2250 x 446			
650 x 496	2250 x 496			
1495 x 396	2250 x 596			
1495 x 446				
1495 x 496				
			Full Open Frames	MTM
			1495 x 396 (Unglazed)	
			1495 x 496 (Unglazed)	
			1595 x 396 (Unglazed)	
			1595 x 496 (Unglazed)	
			2150 x 396 (Unglazed)	
			2150 x 496 (Unglazed)	
			2250 x 396 (Unglazed)	
			2250 x 496 (Unglazed)	

Non-Standard Kitchen Door Sizes - Priced next door size up plus 40%.

Drilling - Additional charge per hole.

Non-Standard Curved Kitchen Door Sizes - Priced next size up.

Curved Kitchen Doors available any height up to 2250mm

Concave Kitchen Doors are not available.

5Piece Curved Kitchen Door Specifications - See page 84.

All Standard Kitchen Plain Frame Sizes are supplied Glazed.

Non-Standard Kitchen Plain Frame Sizes are supplied Unglazed.

Non-Standard Kitchen Frame Sizes - Priced next door size up plus 40%.

MTM Frames - Supplied as individual pieces and require manual assembly.

Non-Standard Bedroom Door Sizes - Priced next door size up plus 40%.

Drilling - Additional charge per hole.

Non-Standard Curved Bedroom Door Sizes - Priced next size up.

Curved Bedroom Doors available any height up to 2250mm

Concave Bedroom Doors are not available.

5Piece Curved Bedroom Door Specifications - See page 84.

All Bedroom Frame Sizes are supplied Unglazed.

Top Open Frames are available.

Non-Standard Bedroom Frame Sizes - Priced next door size up plus 40%.

MTM Frames - Supplied as individual pieces and require manual assembly.

Panelled Bedroom Doors - Bedroom Door sizes between 1735mm - 2400mm high are supplied as single panels with one separate 75mm mid-rail as standard. The mid-rail must then be attached manually during installation. For Panelled Bedroom Doors you must clearly state 3, 4 or 5 panels when ordering to ensure the extra 75mm mid-rail pieces are included with your order.

Extra Mid-Rails - Additional charge per Mid-Rail.



Fenwick | Handleless Rail System Door Sizes



Plain Panel
(18mm thick)



Internal Corner Post
685 x 70 x 70mm



External Corner Post
685 x 46 x 46mm



Handleless Rail System Door Sizes				
Kitchen Door Sizes		Bedroom Door Sizes		
160 x 296	490 x 296	1400 x 263	1500 x 413	2150 x 563
160 x 396	490 x 396	1400 x 281	1500 x 431	2150 x 581
160 x 446	490 x 446	1400 x 313	1500 x 463	2250 x 263
160 x 496	490 x 496	1400 x 331	1500 x 481	2250 x 281
160 x 596	490 x 596	1400 x 363	1500 x 513	2250 x 313
160 x 796	685 x 146	1400 x 381	1500 x 531	2250 x 331
160 x 896	685 x 296	1400 x 413	1500 x 563	2250 x 363
160 x 996	685 x 315	1400 x 431	1500 x 581	2250 x 381
325 x 496	685 x 346	1400 x 463	2150 x 263	2250 x 413
325 x 596	685 x 396	1400 x 481	2150 x 281	2250 x 431
325 x 796	685 x 446	1400 x 513	2150 x 313	2250 x 463
325 x 896	685 x 496	1400 x 531	2150 x 331	2250 x 481
325 x 996	685 x 596	1400 x 563	2150 x 363	2250 x 513
		1400 x 581	2150 x 381	2250 x 531
		1500 x 263	2150 x 413	2250 x 563
		1500 x 281	2150 x 431	2250 x 581
		1500 x 313	2150 x 463	
		1500 x 331	2150 x 481	
		1500 x 363	2150 x 513	
		1500 x 381	2150 x 531	

Drilling - Additional charge per hole.

Save time & money with **automatic pricing** through our online ordering service.

Order online at weborders.osdoors.com

Important: Always ensure doors are shielded from heat sources through the use of heat deflectors.

See page 212 for full range of heat deflector sizes.

5 Piece | Ex: Stock and MTO

Fenwick | Door Specifications

5 Piece | Ex-Stock and MTO

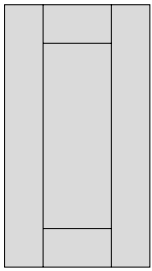

Fenwick Kitchen Door

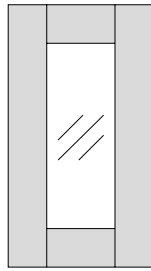

Fenwick Kitchen Glazed Frame

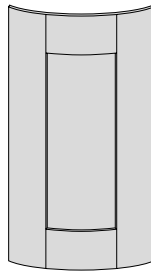

Fenwick Kitchen Curved Door



Fenwick Drawer

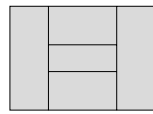

Fenwick Pan Drawer

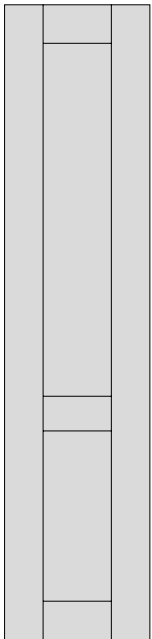

Fenwick Bedroom Standard 2 Panel Door

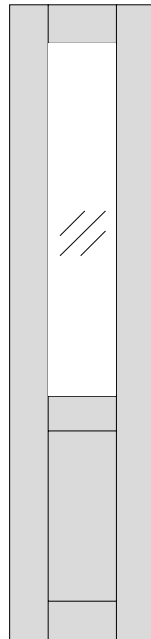

Fenwick Bedroom Top Open Frame

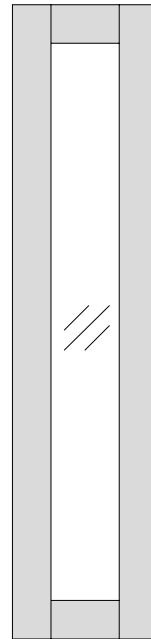

Fenwick Bedroom Full Open Frame

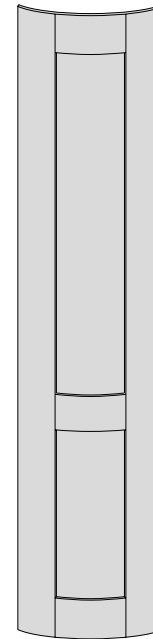

Fenwick Bedroom Curved Door

SPLIT DIMENSIONS

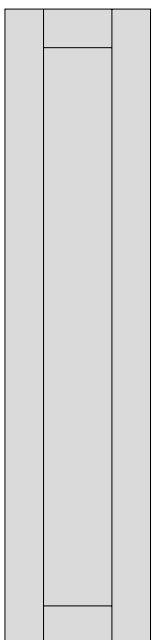

Fenwick Bedroom Single Panel Door
No mid-rails included*

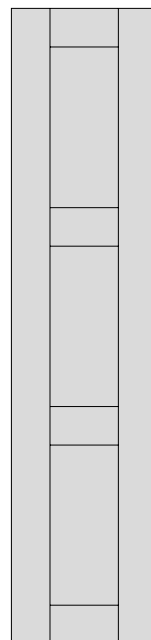

Fenwick Bedroom 3 Panel Door
Includes 2 separate mid-rail pieces*

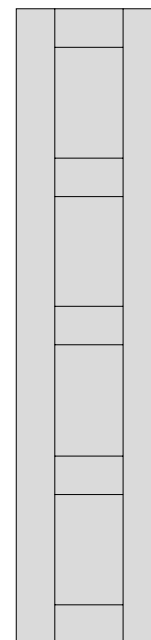

Fenwick Bedroom 4 Panel Door
Includes 3 separate mid-rail pieces*

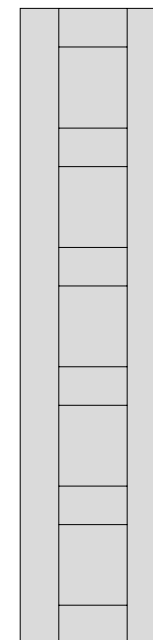

Fenwick Bedroom 5 Panel Door
Includes 4 separate mid-rail pieces*

Fenwick Kitchen Doors:

Kitchen Door sizes between 356 - 2400mm high are supplied 5-piece as standard. The centre panel grain direction will always be vertical. Minimum Door width 246mm. Beneath this a 146mm single wrapped profile can be ordered MTM in height only.

Fenwick Drawers:

Drawer sizes between 100 - 215mm high are supplied as 1-piece flat panels (See drawer visual for reference).

MTM height Drawers are manufactured from the next nearest profile size (115, 140, 175 and 215mm high) with the bottom cut and edged. This edge should always be placed at the bottom during installation. Drawers are supplied with horizontal grain.

Minimum Drawer width 246mm. Drawers are not available between 216 - 219mm high.

Pan Drawer sizes between 220 - 355mm high are supplied as 5-piece. The centre panel grain direction will always be vertical. Minimum Pan Drawer width 246mm.

It's important to specify either Door, Drawer or Pan Drawer when ordering to ensure your order is processed correctly.

Fenwick Frames:

Full Open Frames between 250 - 2400mm high are supplied as single panels as standard.

Top Open Frames are available.

Standard Kitchen Frame sizes are supplied glazed. Non-Standard Frame Sizes are supplied unglazed.

MTM Frames are supplied as individual pieces and require manual assembly.

Minimum Frame width is 246mm.

Fenwick Curved Doors:

Curved Doors are made to suit 300 x 300mm cabinets only. Height availability ranges from 570mm up to 2250mm. Curved Doors are supplied with a 105mm mid-rail which position is variable for each order (please specify required dimensions of split dimensions). The mid rail is measured from the base of the door to the centre of the mid rail unless otherwise specified. The centre panel grain direction will always be vertical.

Concave Doors are not available.

Fenwick Bedroom Doors:

Bedroom Door sizes between 1735 - 2400mm high are supplied as single panels with a separate 105mm mid-rail as standard. The mid-rail must then be attached manually during installation.

*Panelled Bedroom Doors must clearly state 3, 4 or 5 when ordering to ensure the extra 105mm mid-rail pieces are included with your order.

The centre panel grain direction will always be vertical. Minimum Door width is 246mm. Beneath this a 146mm single wrapped profile can be ordered MTM height only.

Drilling:

All Doors are supplied un-drilled unless requested by the customer. If drilling is required, then drilling instructions must be clearly stated along with full dimensions for all holes required.

Angled Doors and Frames are not available.

Fenwick Door Cross Section

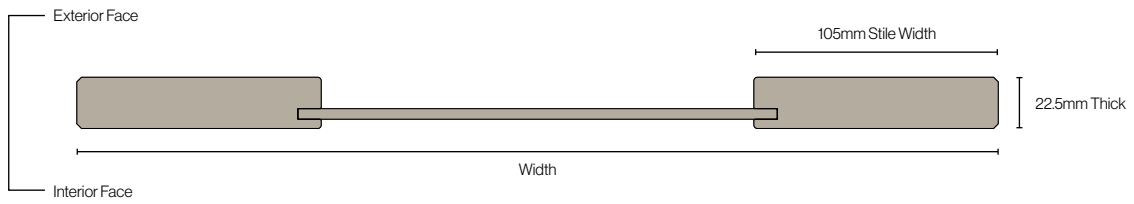

Fenwick Stile Cross Section

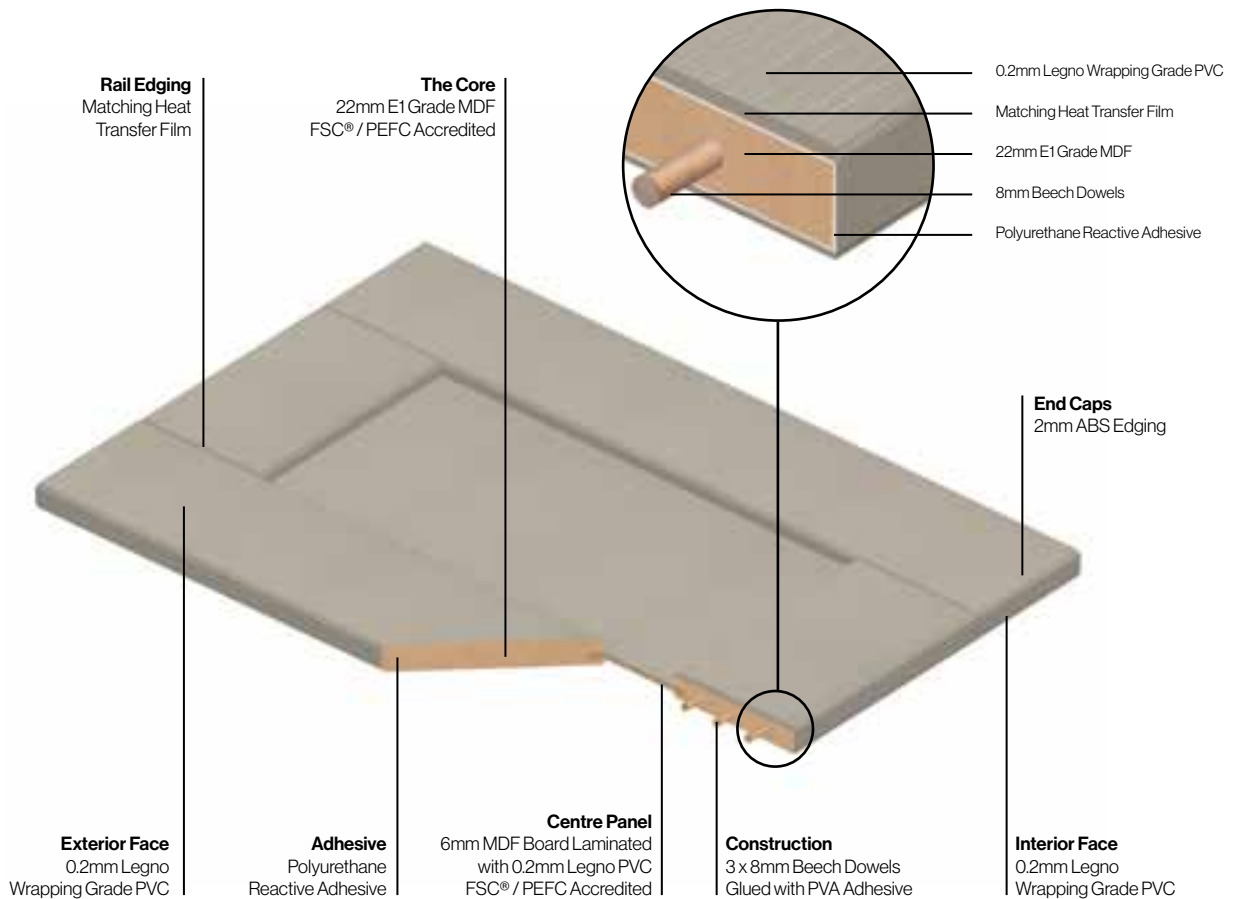
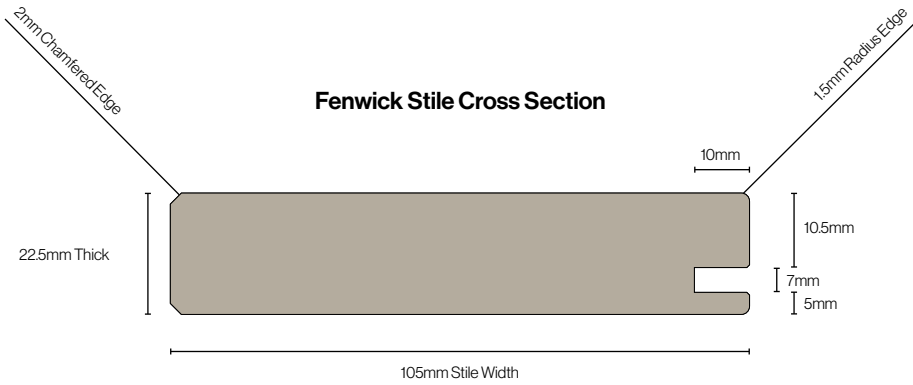

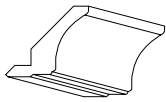

Classic Cornice
76mm (W) x 63mm (H)
3050mm Lengths

EXS

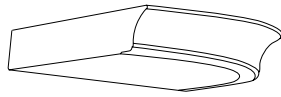

Curved Classic Cornice
364mm (L) x 364mm (W)
x 63mm (H)

MTM

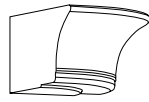

Classic Cornice Quadrant
84mm (L) x 84mm (W)
x 63mm (H)

MTM

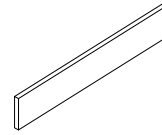

Plain Plinth
18mm (W) x 150mm (H)
3050mm Lengths

EXS

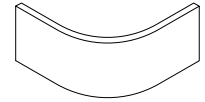

Curved Plain Plinth
300mm (L) x 300mm (W)
x 150mm (H)

MTM

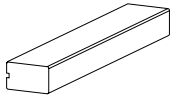

Modern Cornice / Pelmet
50mm (W) x 30mm (H)
3050mm Lengths

EXS

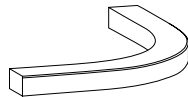

Curved Modern Cornice / Pelmet
350mm (L) x 350mm (W)
x 30mm (H)

MTM

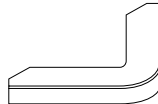

Modern Cornice / Pelmet Quadrant
220mm (L) x 220mm (W)
x 30mm (H)

MTM

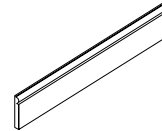

Torus Plinth
18mm (W) x 150mm (H)
3050mm Lengths

MTM



Curved Torus Plinth
300mm (L) x 300mm (W)
x 150mm (H)

MTM

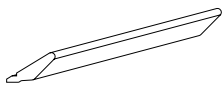

Tangent Cornice
72mm (W) x 44mm (H)
3050mm Lengths

EXS

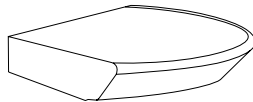

Curved Tangent Cornice
400mm (L) x 400mm (W)
x 44mm (H)

MTM



Tangent Cornice Quadrant
88mm (L) x 88mm (W)
x 44mm (H)

MTM

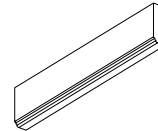

Tangent Pelmet
18mm (W) x 57mm (H)
3050mm Lengths

EXS

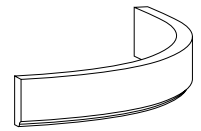

Curved Tangent Pelmet
300mm (L) x 300mm (W)
x 57mm (H)

MTM



MTM Corner Post
715mm (150 x 150mm Max)

MTM

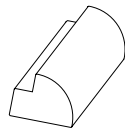

Radius Profile (R 48mm)
70mm (W) x 50mm (H)
3050mm Lengths

EXS

Limited Finishes. See Page 46.

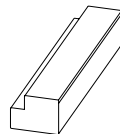

Square Base Pilaster
70mm (W) x 50mm (H)
3050mm Lengths

EXS

Limited Finishes. See Page 46.

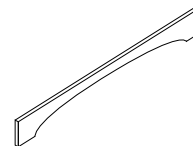

Arched Pelmet
2400mm (L) x 18mm (W)
x 200mm (H)

MTM

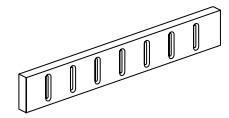

Fluted Rail
18mm (W) x 60mm (H)
2500mm Lengths

MTM

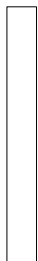

Plain Pilaster
100mm (W) x 900mm (H)
MTM up to 2500mm

MTM



Fluted Pilaster
100mm (W) x 900mm (H)
MTM up to 2500mm

MTM



Special Pilaster
100mm (W) x 900mm (H)
MTM up to 2500mm

MTM



Reeded Pilaster
100mm (W) x 900mm (H)
MTM up to 2500mm

MTM



Gun Barrel Pilaster
90mm (W) x 900mm (H)
90mm (W) x 1250 (H)
94mm (W) x 2150 (H)

EXS



Roman Reed Pilaster
90mm (W) x 900mm (H)
90mm/94mm (W) x 1250 (H)
94mm (W) x 2150 (H)

EXS

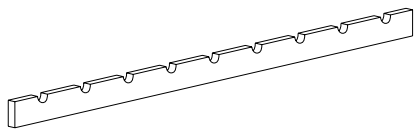

Wine Rack Rail
1200mm (L) x 18mm (W)
x 60mm (H)

MTM

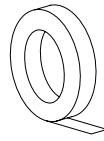

Pre-Glued Edging Tape
50m Roll.

EXS

Not available in Legno Marine Blue,
Legno Taupe and Legno White Grey

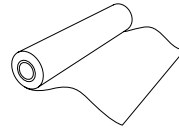

Peel 'n' Stick
Per m2

EXS

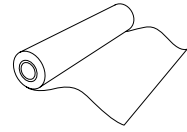

Vinyl
Per m2

EXS

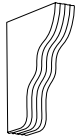

Shelf Bracket
180mm (D) x 37mm (W)
x 210mm (H)

MTM

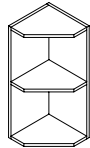

Wall Quad / Base Quad
MTM

MTM

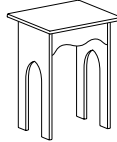

Stool
400mm (L) x 350mm (W)
x 470mm (H)

MTM

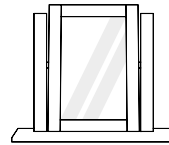

Single Square Mirror
485mm (W) x 570mm (H)

MTM

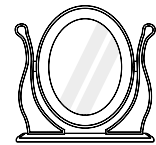

Single Oval Mirror
485mm (W) x 570mm (H)

MTM

See page 88 for all full mirror dimensions

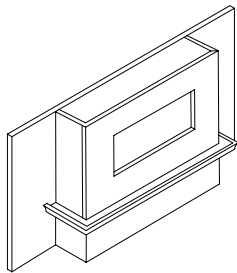

Classic Canopy
1000mm (W) x 215mm (D)
x 485mm (H)

MTM

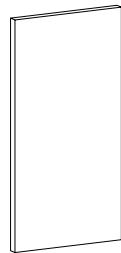

Flat Laminated Panel
18mm Thick

Standard Size MM:
785X360
900X650
965X360
2400X650

EXS

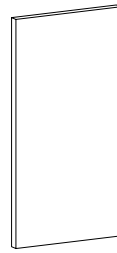

Pressed Plain Panel
18mm Thick

Standard Sizes MM:
785 x 360mm
900 x 650mm
900 x 1200mm
965 x 360mm
2400 x 360mm
2400 x 650mm

Made to Measure per m2

MTM

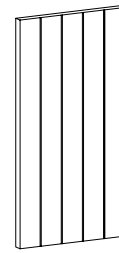

Pressed T&G Panel
18mm Thick

Standard Sizes MM:
785 x 360mm
900 x 650mm
900 x 1200mm
965 x 360mm
2400 x 360mm
2400 x 650mm

Made to Measure per m2

MTM

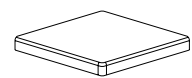

Moulded Top
Made to Measure per m2

MTM

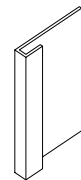

Return Gable
Made to Measure per m2
See page 222 for Order Form

MTM

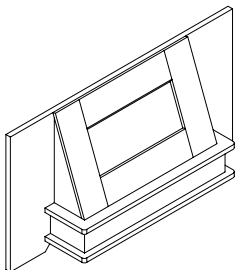

Modern Canopy
1000mm (L) x 193mm (D)
x 525mm (H)

MTM

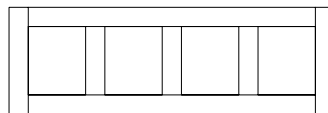
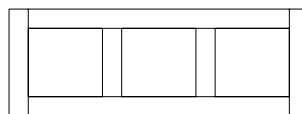
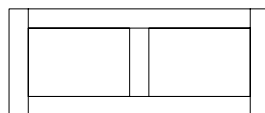
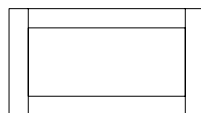

Headboards MTM
MTM per m2.

5Piece Headboards are supplied as single panels in design of your chosen door style as standard. Panelled Headboards must be clearly specified when ordering.

Height Range: 500mm - 900mm
Width Range: 915mm - 1830mm

Standard Size MM:	Panel Availability:
3ft Headboard / 915mm	Single Panel
4ft Headboard / 1208mm	Single & 2 Panel
4.6ft Headboard / 1371mm	Single, 2 & 3 Panel
5ft Headboard / 1510mm	Single, 2, 3 & 4 Panel
6ft Headboard / 1830mm	Single, 2, 3 & 4 Panel

EXS Available Ex:Stock (Limited Finishes).
Ready for 48h despatch.

MTM Available Made to Measure.
Ready for despatch in 5 working days.

Bastille | 5Piece Collection

5 Piece | Ex:Stock and MTO



Door Specification

Description	5Piece Beaded Shaker Style Door with 84mm Stiles
Finish	Wrapped in Solid, Uni-Colour, Legno Grain Embossed Vinyl
Door Thickness	22mm Thick
Base Material	MDF Core
Special Features	French-Cut Door Construction Provides Extra Durability
Edge	2mm ABS End Caps and Chamfered Edges



7 Ex:Stock
Legno Finishes



Available
Made to Measure



Uni-Colour
Vinyl



Embossed
Texture



Durable
Construction

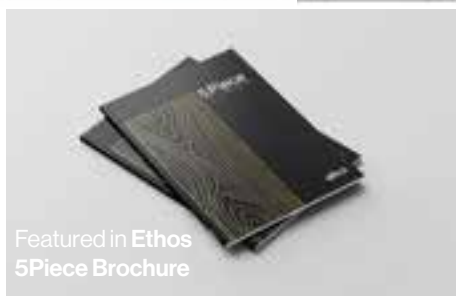

Featured in Ethos
5Piece Brochure



Bastille | Colours / Finishes



Legno White Grey



Legno Taupe



Legno Light Grey

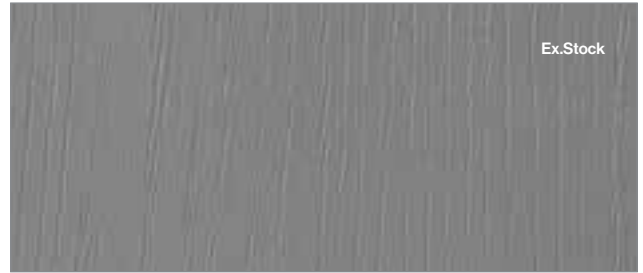

Legno Dust Grey



Legno Graphite



Legno Evergreen



Legno Indigo

The Bastille Door colour offering is being expanded with the addition of three new colours Legno Graphite, Legno Indigo and Legno Evergreen.

Note - Colour swatches shown are approximate. Please use Colour Swatch Book for a true colour match.

Bastille | Door and Drawer Sizes

5 Piece | Ex:Stock and MTO



Kitchen Door Sizes				
Doors and Drawer Sizes		EXS	Curved Door Sizes	MTM
115X596	355X896	895X296	715 x 300	
140X296	355X996	895X396	895 x 300	
140X396	450X596	895X446	1245 x 300	
140X446	500X596	895X496	1965 x 300	
140X496	570X296	895X596		
140X596	570X396	980X596		
140X796	570X446	1060X396		
140X896	570X496	1060X496		
140X996	570X596	1060X596		
175X396	715X146	1245X296	715X396 (Glazed)	EXS
175X496	715X246	1245X396	715X496 (Glazed)	
175X596	715X256	1245X496	895X396 (Glazed)	
283X496	715X296	1245X596	895X496 (Glazed)	
283X596	715X313		1060X396 (Glazed)	
283X796	715X346		1060X496 (Glazed)	
283X896	715X396		1060X596 (Glazed)	
283X996	715X446			
355X496	715X496			
355X596	715X546			
355X796	715X596			

Bedroom Door Sizes				
Doors and Drawer Sizes		MTM	Curved Door Sizes	MTM
215 x 296	1595 x 396		1495 x 300	
215 x 396	1595 x 446		1595 x 300	
215 x 446	1595 x 496		2150 x 300	
215 x 496	1730 x 396		2250 x 300	
215 x 596	1730 x 446			
215 x 796	1730 x 496			
215 x 896	2150 x 296			
215 x 996	2150 x 346			
415 x 396	2150 x 396			
415 x 446	2150 x 446			
415 x 496	2150 x 496			
515 x 396	2150 x 596			
515 x 446	2250 x 296			
515 x 496	2250 x 346			
650 x 396	2250 x 396			
650 x 446	2250 x 446			
650 x 496	2250 x 496			
1495 x 396	2250 x 596			
1495 x 446				
1495 x 496				

Non-Standard Kitchen Door Sizes - Priced next door size up plus 40%

Drilling - Additional charge per hole.

Non-Standard Curved Kitchen Door Sizes - Priced next door size up
Curved Kitchen Doors available any height up to 2250mm
Concave Kitchen Doors are not available.

5Piece Curved Kitchen Door Specifications - See page 84.

All Standard Kitchen Plain Frame Sizes are supplied Glazed.
Non-Standard Kitchen Plain Frame Sizes are supplied Unglazed.
Non-Standard Kitchen Frame Sizes - Priced next door size up plus 40%.
MTM Frames - Supplied as individual pieces and require manual assembly.

Non-Standard Bedroom Door Sizes - Priced next door size up plus 40%

Drilling - Additional charge per hole.

Non-Standard Curved Bedroom Door Sizes - Priced next door size up
Curved Bedroom Doors available any height up to 2250mm
Concave Bedroom Doors are not available.

5Piece Curved Bedroom Door Specifications - See page 84.

All Bedroom Frame Sizes are supplied Unglazed.
Top Open Frames are not available.
Non-Standard Bedroom Frame Sizes - Priced next door size up.
MTM Frames - Supplied as individual pieces and require manual assembly.



Bastille | Handleless Rail System Door Sizes



Plain Panel
(18mm thick)



Internal Corner Post
685 x 70 x 70mm



External Corner Post
685 x 46 x 46mm



Handleless Rail System Door Sizes				
Kitchen Door Sizes		Bedroom Door Sizes		
160 x 296	490 x 296	1400 x 263	1500 x 413	2150 x 563
160 x 396	490 x 396	1400 x 281	1500 x 431	2150 x 581
160 x 446	490 x 446	1400 x 313	1500 x 463	2250 x 263
160 x 496	490 x 496	1400 x 331	1500 x 481	2250 x 281
160 x 596	490 x 596	1400 x 363	1500 x 513	2250 x 313
160 x 796	685 x 146	1400 x 381	1500 x 531	2250 x 331
160 x 896	685 x 296	1400 x 413	1500 x 563	2250 x 363
160 x 996	685 x 315	1400 x 431	1500 x 581	2250 x 381
325 x 496	685 x 346	1400 x 463	2150 x 263	2250 x 413
325 x 596	685 x 396	1400 x 481	2150 x 281	2250 x 431
325 x 796	685 x 446	1400 x 513	2150 x 313	2250 x 463
325 x 896	685 x 496	1400 x 531	2150 x 331	2250 x 481
325 x 996	685 x 596	1400 x 563	2150 x 363	2250 x 513
		1400 x 581	2150 x 381	2250 x 531
		1500 x 263	2150 x 413	2250 x 563
		1500 x 281	2150 x 431	2250 x 581
		1500 x 313	2150 x 463	
		1500 x 331	2150 x 481	
		1500 x 363	2150 x 513	
		1500 x 381	2150 x 531	

Drilling - Additional charge per hole.

Save time & money with **automatic pricing** through our online ordering service.

Order online at weborders.osdoors.com

Important: Always ensure doors are shielded from heat sources through the use of heat deflectors.

See page 212 for full range of heat deflector sizes.

5 Piece | Ex: Stock and MTO

Bastille | Door Specifications

5 Piece | Ex:Stock and MTO

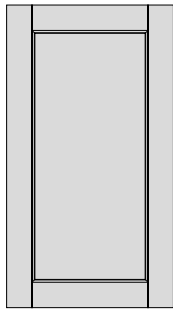

Bastille Kitchen Door

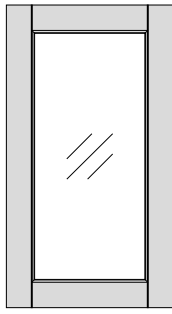

Bastille Kitchen Glazed Frame

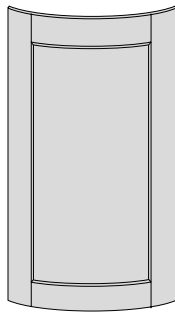

Bastille Kitchen Curved Door



Bastille Drawer

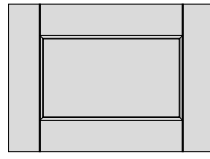

Bastille Pan Drawer

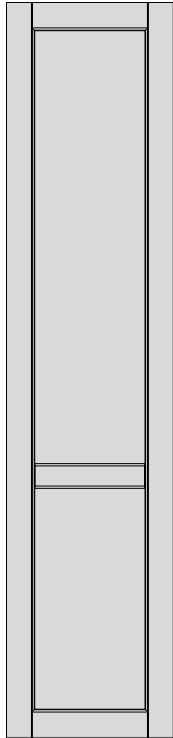

Bastille Bedroom Standard 2 Panel Door

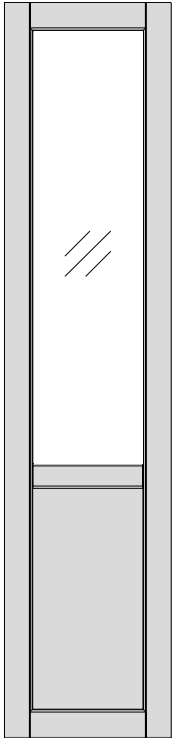

Bastille Bedroom Top Open Frame

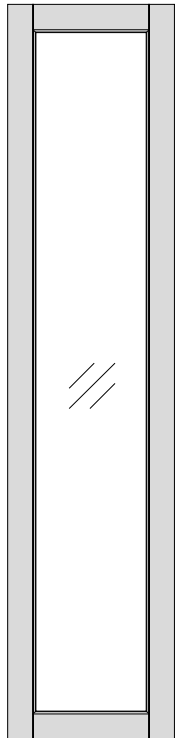

Bastille Bedroom Frame

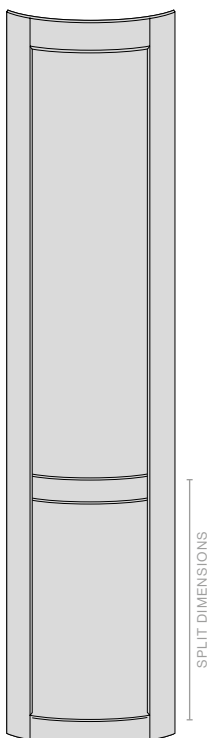

Bastille Bedroom 2 Panel Curved Door

SPLIT DIMENSIONS

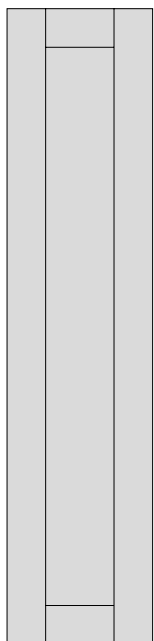

Bastille Bedroom Single Panel Door
No mid-rails included*

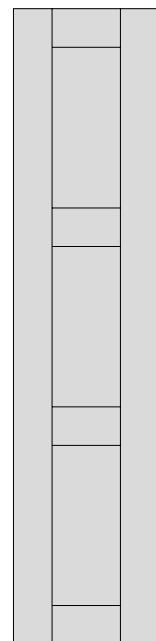

Bastille Bedroom 3 Panel Door
Includes 2 separate mid-rail pieces*

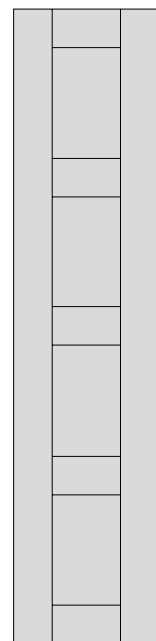

Bastille Bedroom 4 Panel Door
Includes 3 separate mid-rail pieces*

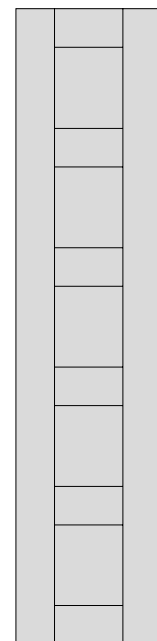

Bastille Bedroom 5 Panel Door
Includes 4 separate mid-rail pieces*

Bastille Kitchen Doors:

Kitchen Door sizes between 283 - 2400mm high are supplied 5-piece as standard. The centre panel grain direction will always be vertical.

Minimum Door width 246mm. Beneath this a 146mm single wrapped profile can be ordered MTM in height only.

Mid-Rails are available.

Bastille Drawers:

Drawer sizes between 100 - 215mm high are supplied as 1-piece flat panels (See drawer visual for reference).

MTM height Drawers are manufactured from the next nearest profile size (115, 140, 146, 175 and 215mm high) with the bottom cut and edged. This edge should always be placed at the bottom during installation. Drawers are supplied with horizontal grain.

Minimum Drawer width 246mm. Drawers are not available between 216 - 283mm high.

Pan Drawer sizes between 283 - 355mm high are supplied as 5-piece. The centre panel grain direction will always be vertical. Minimum Pan Drawer width 246mm.

It's important to specify either Door, Drawer or Pan Drawer when ordering to ensure your order is processed correctly.

Bastille Frames:

Full Open Frames between 283 - 2400mm high are supplied as single panels as standard. It's important to always specify either Full Open Frame when ordering to ensure your order is processed correctly.

Top Open Frames are available.
Georgian Frames are not available.

Standard Kitchen Frame sizes are supplied glazed.
Non-Standard Frame Sizes are supplied unglazed.

Non-Standard MTM Frames are supplied as individual pieces and require manual assembly.

Minimum Frame width is 246mm.

Bastille Curved Doors:

Curved Doors are made to suit 300 x 300mm cabinets only. Height availability ranges from 570mm up to 2250mm. Curved Doors are supplied as single panels as standard. The centre panel grain direction will always be vertical.

Mid-Rails are available.
Concave Doors are not available.

Bastille Bedroom Doors:

Bedroom Door sizes between 1735 - 2400mm high are supplied as single panels with a separate 105mm mid-rail as standard. The mid-rail must then be attached manually during installation.

*Panelled Bedroom Doors must clearly state 3, 4 or 5 when ordering to ensure the extra 105mm mid-rail pieces are included with your order.

The centre panel grain direction will always be vertical. Minimum Door width is 246mm. Beneath this a 146mm single wrapped profile can be ordered MTM height only.

Drilling:

All Doors are supplied un-drilled unless requested by the customer. If drilling is required, then drilling instructions must be clearly stated along with full dimensions for all holes required.

Angled Doors and Frames are not available.

Bastille Door Cross Section

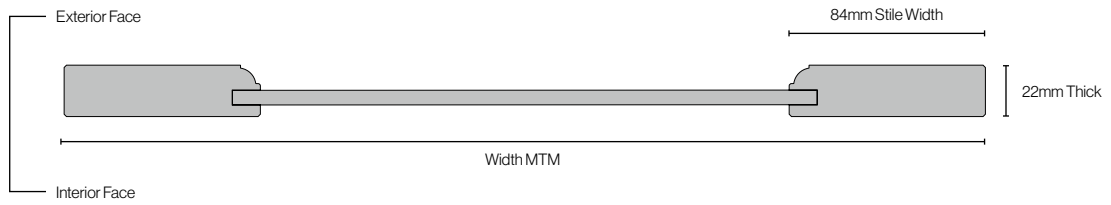

Bastille Stile Cross Section

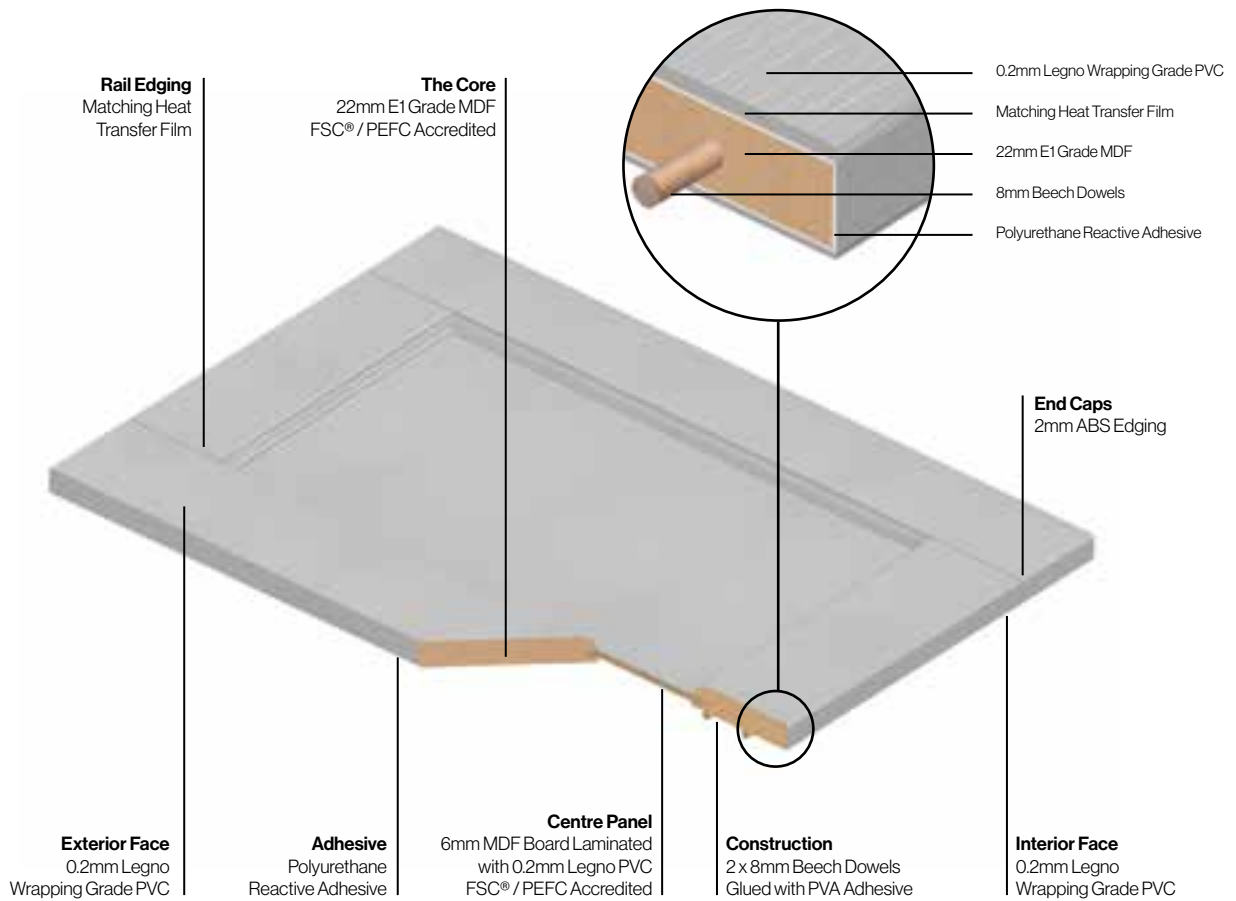
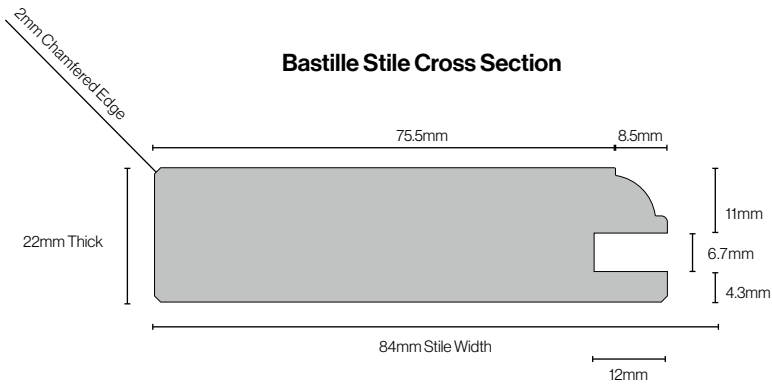

Bastille | Accessories

5 Piece | Ex:Stock and MTO

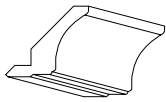

Classic Cornice
76mm (W) x 63mm (H)
3050mm Lengths

EXS

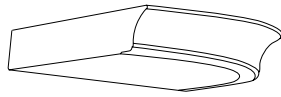

Curved Classic Cornice
364mm (L) x 364mm (W)
x 63mm (H)

MTM

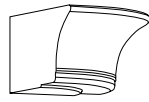

Classic Cornice Quadrant
84mm (L) x 84mm (W)
x 63mm (H)

MTM

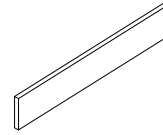

Plain Plinth
18mm (W) x 150mm (H)
3050mm Lengths

EXS

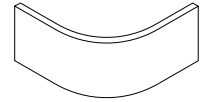

Curved Plain Plinth
300mm (L) x 300mm (W)
x 150mm (H)

MTM

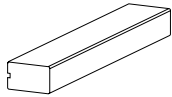

Modern Cornice / Pelmet
50mm (W) x 30mm (H)
3050mm Lengths

EXS

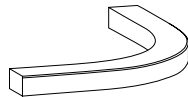

Curved Modern Cornice / Pelmet
350mm (L) x 350mm (W)
x 30mm (H)

MTM

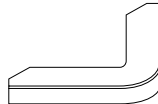

Modern Cornice / Pelmet Quadrant
220mm (L) x 220mm (W)
x 30mm (H)

MTM

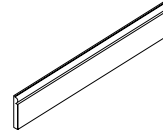

Torus Plinth
18mm (W) x 150mm (H)
3050mm Lengths

MTM



Curved Torus Plinth
300mm (L) x 300mm (W)
x 150mm (H)

MTM

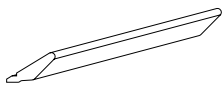

Tangent Cornice
72mm (W) x 44mm (H)
3050mm Lengths

EXS

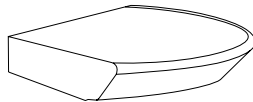

Curved Tangent Cornice
400mm (L) x 400mm (W)
x 44mm (H)

MTM



Tangent Cornice Quadrant
88mm (L) x 88mm (W)
x 44mm (H)

MTM

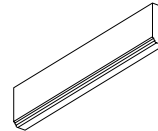

Tangent Pelmet
18mm (W) x 57mm (H)
3050mm Lengths

EXS

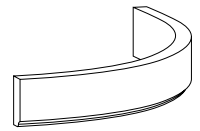

Curved Tangent Pelmet
300mm (L) x 300mm (W)
x 57mm (H)

MTM



MTM Corner Post
715mm (150 x 150mm Max)

MTM

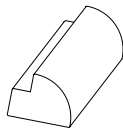

Radius Profile (R 48mm)
70mm (W) x 50mm (H)
3050mm Lengths

EXS

Limited Finishes. See Page 46.

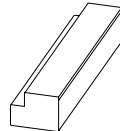

Square Base Pilaster
70mm (W) x 50mm (H)
3050mm Lengths

EXS

Limited Finishes. See Page 46.

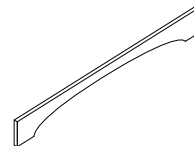

Arched Pelmet
2400mm (L) x 18mm (W)
x 200mm (H)

MTM

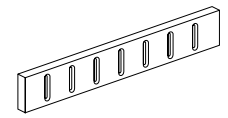

Fluted Rail
18mm (W) x 60mm (H)
2500mm Lengths

MTM

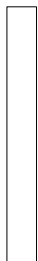

Plain Pilaster
100mm (W) x 900mm (H)
MTM up to 2500mm

MTM



Fluted Pilaster
100mm (W) x 900mm (H)
MTM up to 2500mm

MTM



Special Pilaster
100mm (W) x 900mm (H)
MTM up to 2500mm

MTM



Reeded Pilaster
100mm (W) x 900mm (H)
MTM up to 2500mm

MTM



Gun Barrel Pilaster
90mm (W) x 900mm (H)
90mm (W) x 1250 (H)
94mm (W) x 2150 (H)

EXS



Roman Reed Pilaster
90mm (W) x 900mm (H)
90mm/94mm (W) x 1250 (H)
94mm (W) x 2150 (H)

EXS

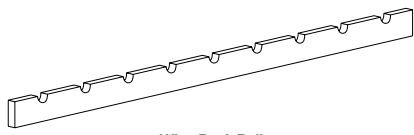

Wine Rack Rail
1200mm (L) x 18mm (W)
x 60mm (H)

MTM

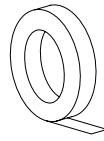

Pre-Glued Edging Tape
50m Roll.

EXS

Not available in Legno White Grey,
Legno Taupe, Legno Marine Blue,
Legno Indigo and Legno Evergreen

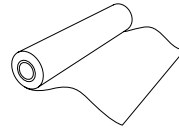

Peel 'n' Stick
Per m2

EXS

Not available in Legno Indigo
and Legno Evergreen

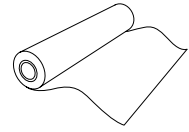

Vinyl
Per m2

EXS



Shelf Bracket
180mm (D) x 37mm (W)
x 210mm (H)

MTM

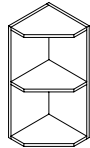

Wall Quad / Base Quad
MTM

MTM

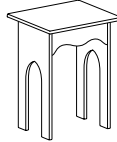

Stool
400mm (L) x 350mm (W)
x 470mm (H)

MTM

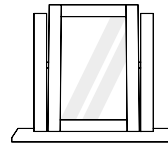

Single Square Mirror
485mm (W) x 570mm (H)

MTM

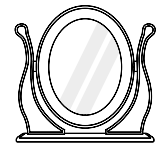

Single Oval Mirror
485mm (W) x 570mm (H)

MTM

See page 88 for all full mirror dimensions

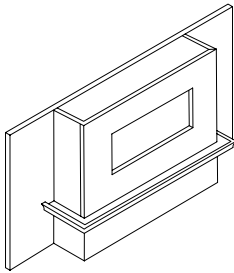

Classic Canopy
1000mm (W) x 215mm (D)
x 485mm (H)

MTM

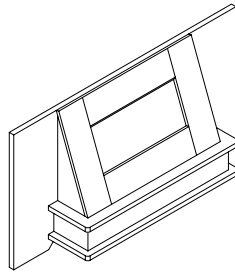

Modern Canopy
1000mm (L) x 193mm (D)
x 525mm (H)

MTM

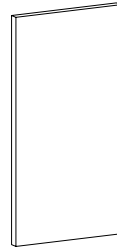

Pressed Plain Panel
18mm Thick

Standard Sizes MM:
785 x 360mm
900 x 650mm
900 x 1200mm
965 x 360mm
2400 x 360mm
2400 x 650mm

Made to Measure per m2

MTM

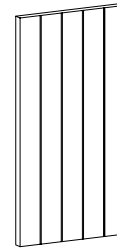

Pressed T&G Panel
18mm Thick

Standard Sizes MM:
785 x 360mm
900 x 650mm
900 x 1200mm
965 x 360mm
2400 x 360mm
2400 x 650mm

Made to Measure per m2

MTM

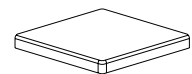

Moulded Top
Made to Measure per m2

MTM

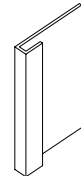

Return Gable
Made to Measure per m2
See page 222 for Order Form

MTM

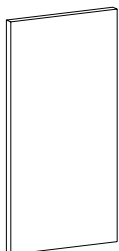

Flat Laminated Panel
18mm Thick

Standard Size MM:
785X360
900X650
965X360
2400X650

EXS

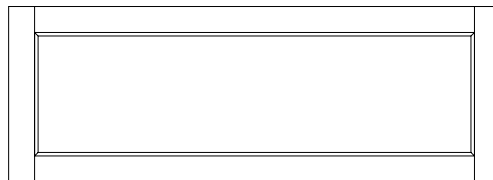

Headboards
MTM per m2.

5Piece Headboards are supplied as single panels in design
of your chosen door style as standard. Panelled Headboards
must be clearly specified when ordering.

Height Range: 500mm - 900mm
Width Range: 915mm - 1830mm

Standard Size MM:	Panel Availability:
3ft Headboard / 915mm	Single Panel
4ft Headboard / 1208mm	Single Panel
4.6ft Headboard / 1371mm	Single Panel
5ft Headboard / 1510mm	Single Panel
6ft Headboard / 1830mm	Single Panel

EXS

Available Ex:Stock (Limited Finishes).
Ready for 48h despatch.

MTM

Available Made to Measure.
Ready for despatch in 5 working days.

5 Piece | Curved Door Specifications







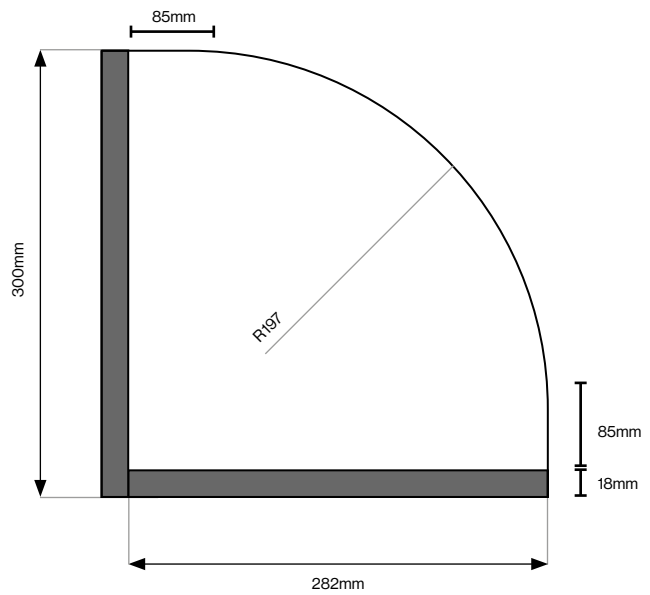





5Piece Curved Doors are made to suit 300mm x 300mm cabinets only. Height availability ranges from 570mm up to 2250mm.





Curved Doors are supplied with a single mid-rail positioned at 660mm high as standard. This is measured from the bottom of the door to the bottom of the mid-rail. The mid-rail position can be changed if necessary and must be clearly stated when ordered as it cannot be moved afterwards.

5 Piece Concave Doors are not available.



5 Piece | RAL Colour Match References

RAL Colour Match References	
O&S Doors Vinyl Colour	RAL Colour Match
 Legno White (Fenwick)	RAL 9003
 Legno Ivory (Fenwick)	RAL 095 93 05
 Legno Taupe (Harlem / Fenwick / Bastille)	RAL 090 85 05
 Legno White Grey (Harlem / Fenwick / Bastille)	RAL 000 90 00
 Legno Light Grey (Harlem / Fenwick / Bastille)	RAL 000 80 00
 Legno Dust Grey (Harlem / Fenwick / Bastille)	RAL 000 60 00
 Legno Graphite (Fenwick / Bastille)	RAL 000 30 00
 Legno Marine Blue (Fenwick)	RAL 260 20 15
 Legno Indigo (Harlem / Bastille)	RAL 280 20 05
 Legno Evergreen (Harlem / Bastille)	RAL 180 20 10
 Legno Black (Harlem)	RAL 000 15 00
 Urban Oak Woodgrain	N/A

RAL Colour Match References	
O&S Doors Vinyl Colour	RAL Colour Match
 Matt White Grey (Dylan)	RAL 000 90 00
 Matt Light Grey (Dylan)	RAL 080 80 00
 Matt Dust Grey (Dylan)	RAL 000 65 00
 Matt Taupe (Dylan)	RAL 080 80 05
 Matt Indigo (Dylan)	RAL 280 20 05

Important Notice: These RAL Colour match references are suggested options only. They are the closest RAL colour match to our vinyl colour, but please note they are not exact matches. Customers are strongly advised to obtain swatch samples to confirm a satisfactory colour match.

The listed RAL Colour matches are correct at time of printing. Due to unforeseen changes to the supply chain O&S Doors Ltd reserve the right due to amend, alter or discontinue finishes without prior notice.

5 Piece | Moulding Specifications

Moulding Finish Availability Index														
Vinyl Colour	Classic Cornice	Modern Cornice / Pelmet	Tangent Cornice	Tangent Pelmet	Plain Plinth	Torus Profiled Plinth	Radius Profile	Corner Post	Square Plaster Profile	Peel & Stick	Pre-Glued Edging Tape*	Un-Glued Edging Tape*	MFC	
Harlem	Legno White Grey	●	●	●	●	●	●	●	●	●	×	●	●	
	Legno Light Grey	●	●	●	●	●	●	●	●	●	●	●	●	
	Legno Dust Grey	●	●	●	●	●	●	●	●	●	●	●	●	
	Legno Taupe	●	●	●	●	●	●	●	●	●	×	●	●	
	Legno Indigo	●	●	●	●	●	●	●	●	●	×	●	●	
	Legno Evergreen	●	●	●	●	●	●	●	●	●	×	●	●	
	Legno Black	●	●	●	●	●	●	●	●	●	×	●	●	
	Urban Oak	●	●	●	●	●	●	●	●	●	×	×	●	
Dylan	Matt White Grey	●	●	●	●	●	×	●	×	●	●	●	●	
	Matt Taupe	●	●	●	●	●	×	●	×	●	●	●	●	
	Matt Light Grey	●	●	●	●	●	●	●	×	●	●	●	●	
	Matt Dust Grey	●	●	●	●	●	×	●	×	●	●	●	●	
	Matt Indigo	●	●	●	●	●	×	●	×	●	●	●	●	
Fenwick	Legno White	●	●	●	●	●	●	●	●	●	●	●	●	
	Legno Ivory	●	●	●	●	●	●	●	●	●	●	●	●	
	Legno Taupe	●	●	●	●	●	●	●	●	●	×	●	●	
	Legno White Grey	●	●	●	●	●	●	●	●	●	×	●	●	
	Legno Light Grey	●	●	●	●	●	●	●	●	●	●	●	●	
	Legno Dust Grey	●	●	●	●	●	●	●	●	●	●	●	●	
	Legno Graphite	●	●	●	●	●	●	●	●	●	●	●	●	
	Legno Marine Blue	●	●	●	●	●	●	●	●	●	×	●	×	
Bastille	Legno White Grey	●	●	●	●	●	●	●	●	●	×	●	●	
	Legno Light Grey	●	●	●	●	●	●	●	●	●	●	●	●	
	Legno Dust Grey	●	●	●	●	●	●	●	●	●	●	●	●	
	Legno Taupe	●	●	●	●	●	●	●	●	●	×	●	●	
	Legno Graphite	●	●	●	●	●	●	●	●	●	●	●	●	
	Legno Indigo	●	●	●	●	●	●	●	●	●	×	●	●	
	Legno Evergreen	●	●	●	●	●	●	●	●	●	×	●	●	

● Available Ex:Stock × Not Available ● Available Pressed to Order

*Edging Tape matches for Superior Matt finishes are colour matches only. They do not have a super smooth matt laminate effect finish.

5 Piece | Moulding Specifications

5 Piece | Ex:Stock and MTO

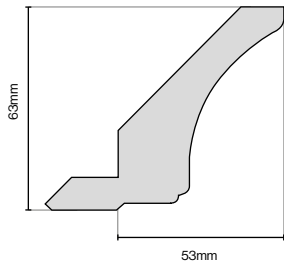

Classic Cornice
3050mm Lengths

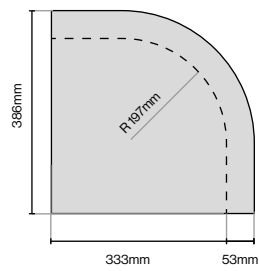

Curved Classic Cornice
386mm (L) x 386mm (W) x 63mm (H)

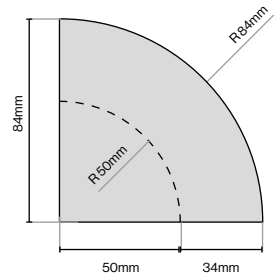

Classic Cornice Quadrant
84mm (L) x 84mm (W) x 63mm (H)

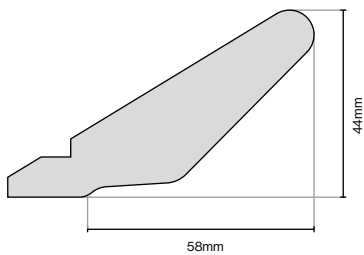

Tangent Cornice
3050mm (L) x 72mm (W) x 44mm (H)

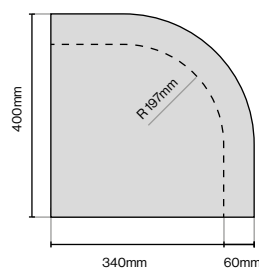

Curved Tangent Cornice
400mm (L) x 400mm (W) x 44mm (H)

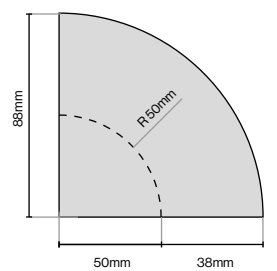

Tangent Cornice Quadrant
88mm (L) x 88mm (W) x 44mm (H)

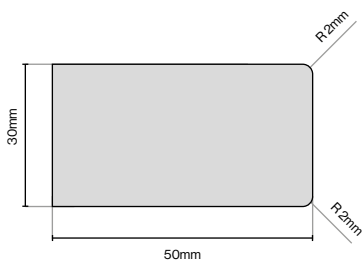

Modern Cornice / Pelmet
3050mm Lengths

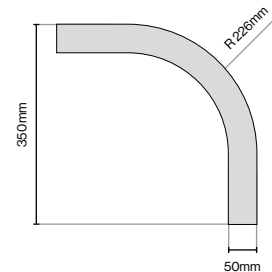

Curved Modern Cornice / Pelmet
350mm (L) x 350mm (W) x 30mm (H)

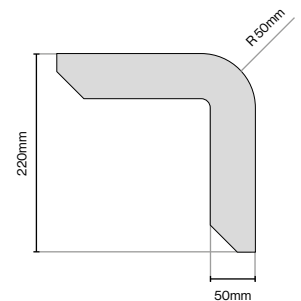

Modern Cornice / Pelmet Quadrant
220mm (L) x 220mm (W) x 30mm (H)

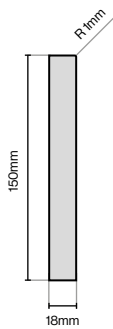

Plain Plinth
3050mm Lengths

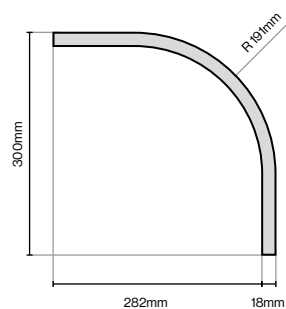

Curved Plain Plinth
300mm (L) x 300mm (W) x 150mm (H)

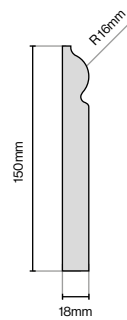

Torus Plinth
3050mm Lengths

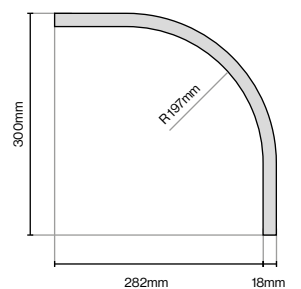

Curved Torus Plinth
300mm (L) x 300mm (W) x 150mm (H)

5 Piece | Moulding Specifications

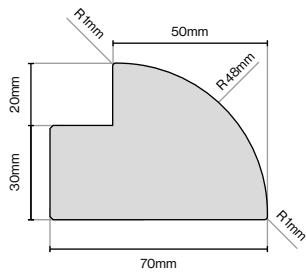

Radius Profile
3050mm Lengths

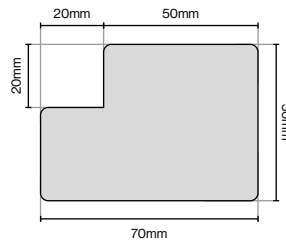

Square Pilaster
3050mm Lengths

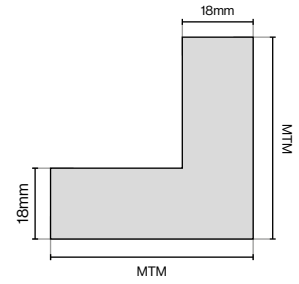

MTM Corner Post
715mm (150 x 150mm Max)

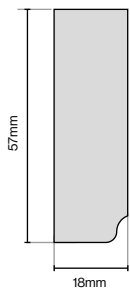

Tangent Pelmet
3050mm Lengths

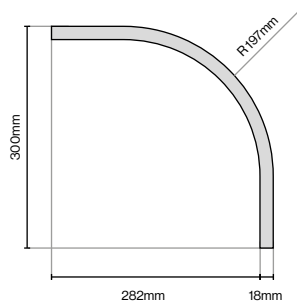

Curved Tangent Pelmet
300mm (L) x 300mm (W) x 150mm (H)

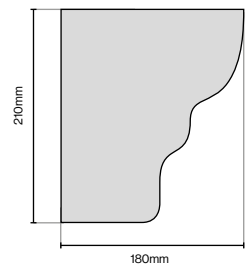

Shelf Bracket
180mm (L) x 37mm (W) 210mm (H)

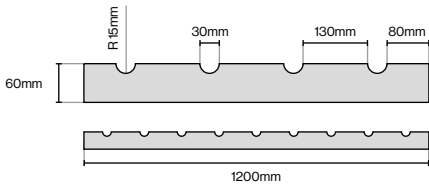

Wine Rack Rail
1200mm (L) x 18mm (W) x 60mm (H)

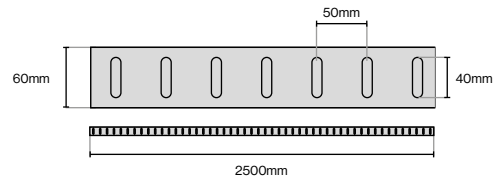

Fluted Rail
2500mm (L) x 18mm (W) x 60mm (H)

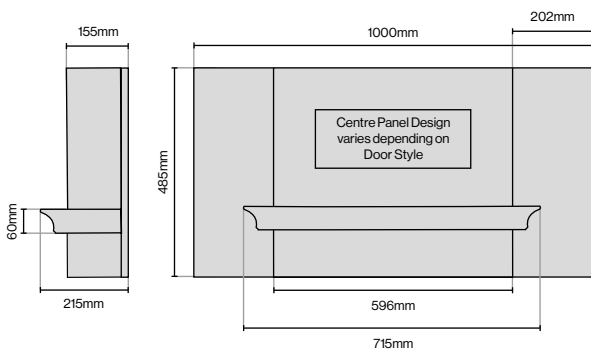

Classic Canopy
1000mm (W) x 215mm (D) x 485mm (H)

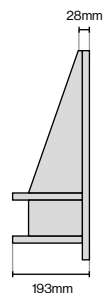

Modern Canopy
1000mm (W) x 193mm (D) x 525mm (H)

5 Piece | Bedroom Accessory Specifications

5Piece Headboard Specifications

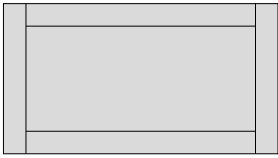
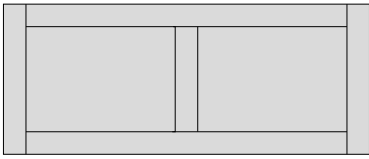
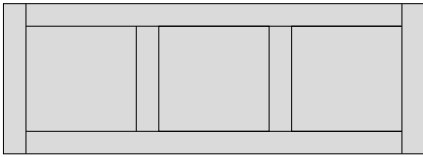
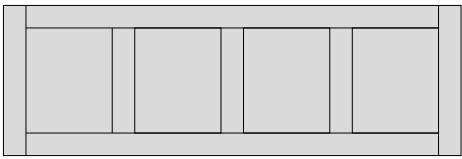
Headboard Type		Height Range MM	Height Range MM
Single Panel		500mm – 900mm	915mm – 1830mm
2 Panel		500mm – 900mm	915mm – 1830mm
3 Panel		500mm – 900mm	1371mm – 1830mm
4 Panel		500mm – 900mm	1510mm – 1830mm

Headboards: All Headboards are supplied rectangular using the design of door style ordered. All Headboards will be supplied as single panels unless otherwise specified.
Bastille Headboards - Available as single panels ONLY.

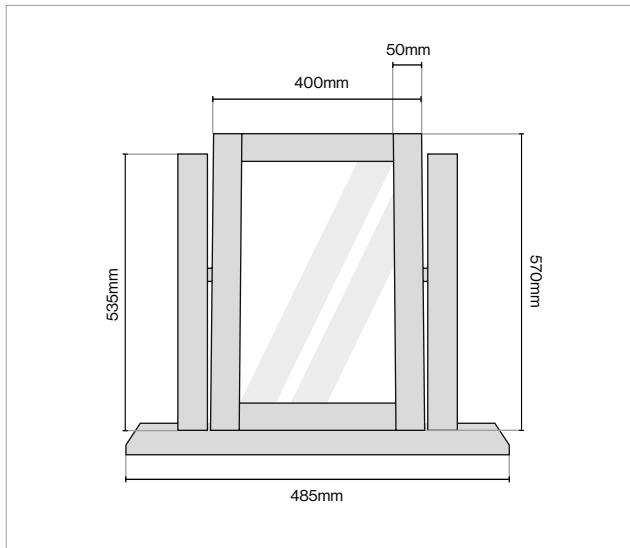

Single Square Mirror: Single Square Mirrors are supplied fully assembled.

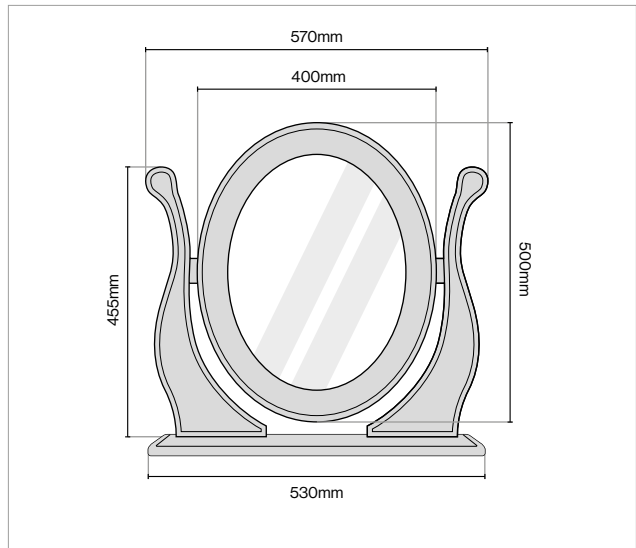

Oval Mirror: Oval Mirrors are supplied fully assembled.

5 Piece | Board Match Specifications

MDF Board Match References		Recommended MFC Board Match References				
	Vinyl Colour	Egger	Kronospan	Pfleiderer	Finsa	Sonae
Harlem	Legno White	W980 ST19	0101 GC	U11015 MO*	White 020	B020
	Legno Light Grey	U708 ST19	0112 GC	U12204 MO*	Natural Grey U12	-
	Legno Dust Grey	-	0171 GC*	U12150 MO	Gris Tormenta S.3	-
	Legno Taupe	U750 ST19*	-	-	-	-
	Legno Indigo	U599 ST19*	-	-	-	-
	Legno Evergreen	U699 ST19*	-	-	-	-
	Legno Black	U999 ST19*	-	-	-	-
Urban Oak	-	-	K005 PW	-	-	-
Dylan	Matt White Grey	U775 ST19*	-	-	-	-
	Matt Taupe	U750 ST19*	-	-	-	-
	Matt Light Grey	U708 ST19*	0112 PE	U12204 MP	Natural Grey U12	-
	Matt Dust Grey	U732 ST9	0171 PE	-	Gris Tormenta S.3*	-
	Matt Indigo	-	-	-	Azul Nautico Smooth*	-
Fenwick	Legno White	W980 ST27	0101 GC	U11015 MO*	White 020	B020
	Legno Ivory	U104 ST27	7031 GC*	U11506 MO	Contempo Ivory 88V	L402
	Legno Taupe	U750 ST19*	-	-	-	-
	Legno White Grey	U775 ST19*	-	-	-	-
	Legno Light Grey	U708 ST27	0112 GC	U12204 MO*	Natural Grey U12	-
	Legno Dust Grey	-	0171 GC*	U12150 MO	Gris Tormenta S.3	-
	Legno Graphite	U961 ST19*	0164 GC	U12018 MO / U12257 MP	Petroleo 188	-
Legno Marine Blue	-	-	-	Azul Nautico Grained*	-	
Bastille	Legno White Grey	U775 ST19*	-	-	-	-
	Legno Light Grey	U708 ST27	0112 GC	U12204 MO*	Natural Grey U12	-
	Legno Dust Grey	-	0171 GC*	U12150 MO	Gris Tormenta S.3	-
	Legno Taupe	U750 ST19*	-	-	-	-
	Legno Graphite	U961 ST19*	0164 GC	U12018 MO / U12257 MP	Petroleo 188	-
	Legno Indigo	U599 ST19*	-	-	-	-
	Legno Evergreen	U699 ST19*	-	-	-	-

*All MFC Board Matches marked in bold are available to order from O&S Doors Ltd, only supplied to Island of Ireland.

Important Notice: These board match references are only suggested options. Customers are strongly advised to obtain samples from their board or cabinet supplier in order to confirm a satisfactory match between the cabinet MFC and 5 Piece door finish.

O&S Doors Ltd do not accept responsibility for any subsequent dissatisfaction between the board and door match. The listed finishes and board matches are correct at time of printing. Due to unforeseen changes in the supply chain, O&S Doors Ltd reserve the right due to amend, alter or discontinue finishes and reverse boards without prior notice. If a match is of the essence a sample should always be sought first for final approval.

We recommend Pressed or Laminated Panels for the closest match.

Distinctive Edging. Streamlined Aesthetics. Premium Finishes. **Choose Edged.**



The Edged Collection provides a range of contemporary door styles, designed with versatility and functionality in mind. Each door is compatible with the integrated Zenith handle.



Phoenix
High Gloss Acrylic Finishes
See Page 92



Tribeca
Superior Matt Finishes
Page 98



Vaasa
MFC Finishes
See Page 104



Mather
Legno MFC Finishes
Page 110



Phoenix | Cut and Edged Gloss Doors

Edged | MTM



Featured in Ethos Edged Brochure

Door Specification

Description	Flat Bonded Gloss Foil Laminated Door
Finish	Available in Ultra High Gloss and Metallic Finishes.
Door Thickness	18mm Thick
Base Material	MDF Core
Special Features	High Scratch Resistance and Highly Durable Core
Edge	1mm ABS Edge with a choice of Matching, Multiplex or Glass Effect.

- 
**Available
Made to Measure**
- 
**8 High Gloss
Finishes**
- 
**High Gloss
Finish**
- 
**Various
Edging Options**
- 
**Integrated
Handle Options**



Phoenix | Colours / Finishes

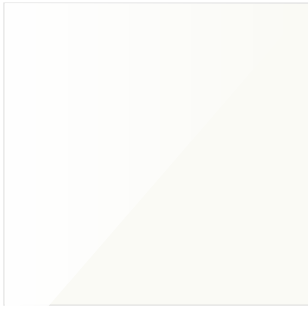

High Gloss White

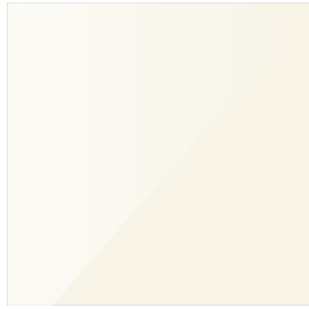

High Gloss Ivory



High Gloss Cashmere

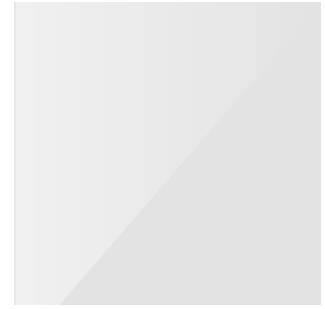

High Gloss Light Grey



High Gloss Dust Grey



High Gloss Graphite

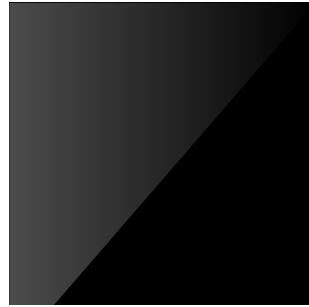

High GlossBlack

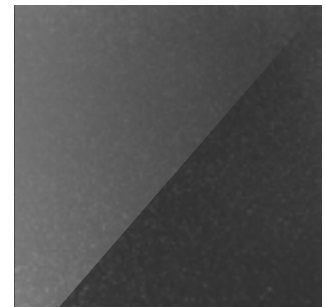

High Gloss Metallic Anthracite

Edging Options



Matching Edge



Multiplex Edge



Glass Effect Edge

Compatible with
the integrated
Zenith Handle

See page 232 for sizes and
technical specifications.



Phoenix | Door and Drawer Sizes



Kitchen Door Sizes				
Doors and Drawer Sizes		MTM	Curved Door Sizes	MTM
115 x 596	355 x 496	715 x 546	715 x 300	
140 x 296	355 x 596	715 x 596	895 x 300	
140 x 396	355 x 796	895 x 296	1245 x 300	
140 x 446	355 x 896	895 x 396	1965 x 300	
140 x 496	355 x 996	895 x 446		
140 x 596	450 x 596	895 x 496		
140 x 796	500 x 596	895 x 596		
140 x 896	570 x 296	980 x 596		
140 x 996	570 x 396	1060 x 396		
175 x 396	570 x 446	1060 x 496		
175 x 496	570 x 496	1060 x 596		
175 x 596	570 x 596	1245 x 296		
175 x 796	715 x 146	1245 x 396		
175 x 896	715 x 246	1245 x 446		
175 x 996	715 x 296	1245 x 496		
283 x 496	715 x 313	1245 x 596		
283 x 596	715 x 346			
283 x 796	715 x 396			
283 x 896	715 x 446			
283 x 996	715 x 496			

Bedroom Door Sizes				
Doors and Drawer Sizes		MTM	Curved Door Sizes	MTM
215 x 296	650 x 396	2150 x 396	1495 x 300	
215 x 396	650 x 446	2150 x 446	1595 x 300	
215 x 446	650 x 496	2150 x 496	2150 x 300	
215 x 496	650 x 596	2150 x 596	2250 x 300	
215 x 546	1495 x 296	2250 x 296		
215 x 596	1495 x 396	2250 x 396		
215 x 796	1495 x 446	2250 x 446		
215 x 896	1495 x 496	2250 x 496		
215 x 996	1495 x 596	2250 x 596		
415 x 296	1595 x 296	2400 x 296		
415 x 396	1595 x 396	2400 x 396		
415 x 446	1595 x 446	2400 x 446		
415 x 496	1595 x 496	2400 x 496		
415 x 596	1595 x 596	2400 x 596		
535 x 296	1735 x 296			
535 x 396	1735 x 396			
535 x 446	1735 x 446			
535 x 496	1735 x 496			
535 x 596	1735 x 596			
650 x 296	2150 x 296			

Non-Standard Kitchen Door Sizes - Priced next door size up.
Maximum Height MTM - 2400mm (H)
Maximum Width MTM - 1200mm (W)
Drilling - Additional charge per hole.

Non Standard Curved Kitchen Door Sizes - Priced next door size up.
Curved Kitchen Doors available any height up to 2250mm
Concave Kitchen Doors are not available.
Phoenix Curved Door Specifications - See page 97.

Kitchen Frames Not Available
Angled Kitchen Door Sizes - Priced as door size plus 50%.
Zenith Handle Rebate - Priced as door size plus 7.5%.
Letterbox Routers - Priced as door size plus 4%.

Non-Standard Bedroom Door Sizes - Priced next door size up.
Maximum Height MTM - 2400mm (H)
Maximum Width MTM - 1200mm (W)
Drilling - Additional charge per hole.

Non Standard Curved Bedroom Door Sizes - Priced next door size up.
Curved Bedroom Doors available any height up to 2250mm
Concave Bedroom Doors are not available.
Phoenix Curved Door Specifications - See page 97.

Bedroom Frames Not Available
Angled Bedroom Door Sizes - Priced as door size plus 50%.
Letterbox Routers - Priced as door size plus 4%.

Phoenix | Handleless Rail System Door Sizes



Plain Panel
(18mm thick)

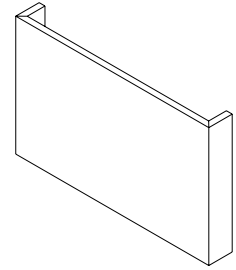

Cloaking End Panel
80mm Minimum End Width



See page 240 for order form

Handleless Rail System Door Sizes

Kitchen Door Sizes



Bedroom Door Sizes



160 x 296	490 x 296	1400 x 263	1500 x 413	2150 x 563
160 x 396	490 x 396	1400 x 281	1500 x 431	2150 x 581
160 x 446	490 x 446	1400 x 313	1500 x 463	2250 x 263
160 x 496	490 x 496	1400 x 331	1500 x 481	2250 x 281
160 x 596	490 x 596	1400 x 363	1500 x 513	2250 x 313
160 x 796	685 x 146	1400 x 381	1500 x 531	2250 x 331
160 x 896	685 x 296	1400 x 413	1500 x 563	2250 x 363
160 x 996	685 x 315	1400 x 431	1500 x 581	2250 x 381
325 x 496	685 x 346	1400 x 463	2150 x 263	2250 x 413
325 x 596	685 x 396	1400 x 481	2150 x 281	2250 x 431
325 x 796	685 x 446	1400 x 513	2150 x 313	2250 x 463
325 x 896	685 x 496	1400 x 531	2150 x 331	2250 x 481
325 x 996	685 x 596	1400 x 563	2150 x 363	2250 x 513
		1400 x 581	2150 x 381	2250 x 531
		1500 x 263	2150 x 413	2250 x 563
		1500 x 281	2150 x 431	2250 x 581
		1500 x 313	2150 x 463	
		1500 x 331	2150 x 481	
		1500 x 363	2150 x 513	
		1500 x 381	2150 x 531	



Internal Corner Post
685 x 70 x 70mm



External Corner Post
685 x 46 x 46mm



Drilling - Additional charge per hole.

Save time & money with **automatic pricing** through our online ordering service.



Order online at weborders.osdoors.com

Important: Always ensure doors are shielded from heat sources through the use of heat deflectors.

See page 226 for full range of heat deflector sizes.



Phoenix | Door Specifications

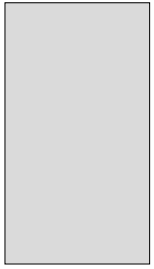

Phoenix Kitchen Door



Phoenix Door with Integrated Handle (Top Edge - Maximum Width 2400mm)



Phoenix Drawer with Integrated Handle (Top Edge - Maximum Width 2400mm)



Phoenix Drawer

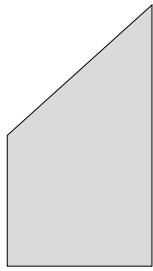

Phoenix Angled Door

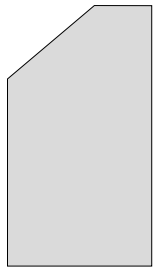

Phoenix Angled Flat Top Door



Phoenix Door with Integrated Handle (Side Edge - Maximum Height 2400mm)



Phoenix Bedroom Door



Phoenix Pan Drawer

Phoenix | Technical Specifications

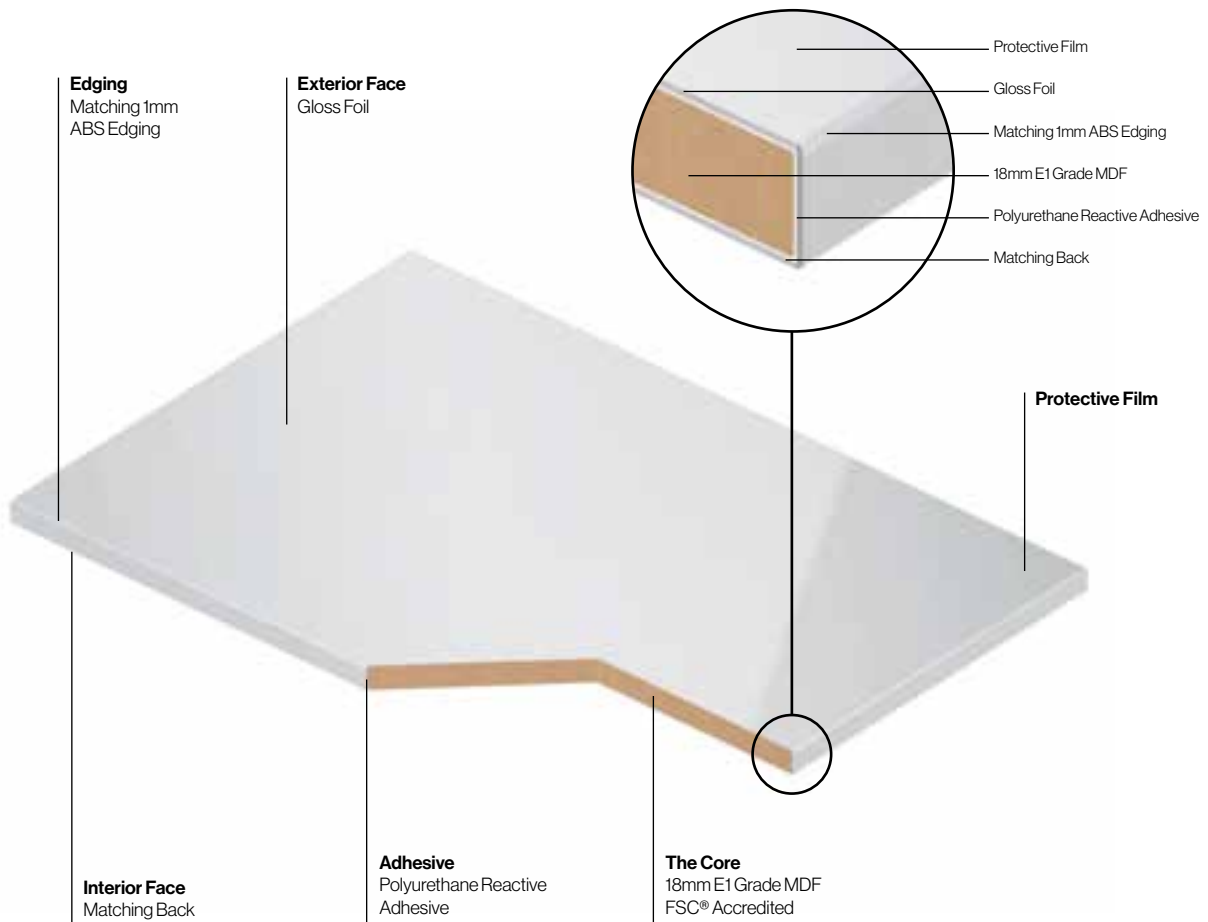

Phoenix | Accessories

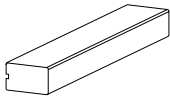

Modern Cornice / Pelmet
50mm (W) x 30mm (H)
3050mm Lengths

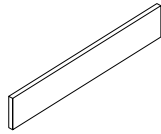

Plain Plinth
18mm (W) x 150mm (H)
2400mm Lengths

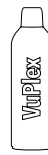

VuPlex Cleaning Spray



Plain Panel
18mm Thick
Supplied Cut and 1mm Edged

Standard Sizes MM:

- 785 x 360mm
- 900 x 650mm
- 900 x 1200mm
- 965 x 360mm
- 2400 x 360mm
- 2400 x 650mm
- 2400 x 1200mm

Made to Measure per m2



Phoenix Kitchen Featured in High Gloss Cashmere



EXS Available Ex.Stock (Limited Finishes).
Ready for 48h despatch.

MTM Available Made to Measure.
Ready for despatch in 5 working days.

Tribeca | Cut and Edged Superior Matt Doors

Edged | MTM



Door Specification

Description	Flat Bonded Door
Finish	Available in a range of Superior Matt Finishes
Door Thickness	18mm Thick
Base Material	18mm E1 Grade MDF Board
Special Features	High Scratch Resistance, Highly Durable Core, Anti-Fingerprint Surface
Edge	1mm ABS Edging with a choice of Matching or Multiplex Finish



Available
Made to Measure



14 Superior Matt
Finishes



Silky Smooth
Soft Touch



Various
Edging Options



Integrated
Handle Options



Featured in Ethos
Edged Brochure



Tribeca | Colours / Finishes



Superior Matt Porcelain

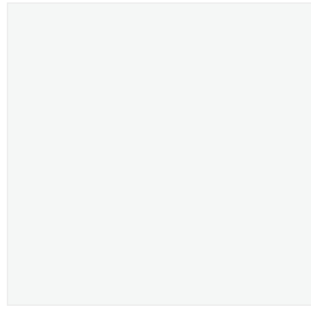

Superior Matt White Grey

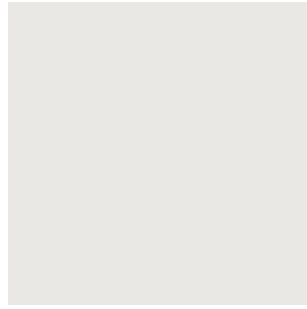

Superior Matt Taupe Grey



Superior Matt Pebble



Superior Matt Stone Grey



Superior Matt Antique Rose

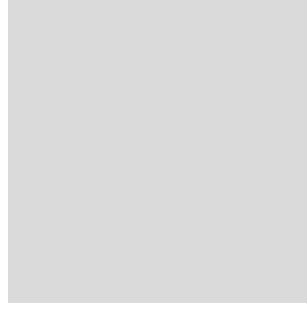

Superior Matt Light Grey



Superior Matt Dust Grey



Superior Matt Graphite



Superior Matt Reed Green



Superior Matt Heritage Green



Superior Matt Marine Blue



Superior Matt Indigo



Superior Matt Black

Edging Options



Matching Edge



Multiplex Edge

Compatible with
the integrated
Zenith Handle

See page 232 for sizes and
technical specifications.



Tribeca | Door and Drawer Sizes



Kitchen Door Sizes

Doors and Drawer Sizes MTM

115 x 596	355 x 496	715 x 546
140 x 296	355 x 596	715 x 596
140 x 396	355 x 796	895 x 296
140 x 446	355 x 896	895 x 396
140 x 496	355 x 996	895 x 446
140 x 596	450 x 596	895 x 496
140 x 796	500 x 596	895 x 596
140 x 896	570 x 296	980 x 596
140 x 996	570 x 396	1060 x 396
175 x 396	570 x 446	1060 x 496
175 x 496	570 x 496	1060 x 596
175 x 596	570 x 596	1245 x 296
175 x 796	715 x 146	1245 x 396
175 x 896	715 x 246	1245 x 446
175 x 996	715 x 296	1245 x 496
283 x 496	715 x 313	1245 x 596
283 x 596	715 x 346	
283 x 796	715 x 396	
283 x 896	715 x 446	
283 x 996	715 x 496	

Non-Standard Kitchen Door Sizes - Priced next door size up.

Maximum Height MTM - 2400mm (H).

Maximum Width MTM - 1200mm (W).

Curved Kitchen Doors Not Available.

Concave Kitchen Doors Not Available.

Kitchen Frames Not Available.

Angled Kitchen Door Sizes - Priced as door size plus 50%.

Zenith Handle Rebate - Priced as door size plus 7.5%.

Letterbox Routing - Priced as door size plus 4%.

Drilling - Additional charge per hole.

Bedroom Door Sizes

Doors and Drawer Sizes MTM

215 x 296	650 x 396	2150 x 396
215 x 396	650 x 446	2150 x 446
215 x 446	650 x 496	2150 x 496
215 x 496	650 x 596	2150 x 596
215 x 546	1495 x 296	2250 x 296
215 x 596	1495 x 396	2250 x 396
215 x 796	1495 x 446	2250 x 446
215 x 896	1495 x 496	2250 x 496
215 x 996	1495 x 596	2250 x 596
415 x 296	1595 x 296	2400 x 296
415 x 396	1595 x 396	2400 x 396
415 x 446	1595 x 446	2400 x 446
415 x 496	1595 x 496	2400 x 496
415 x 596	1595 x 596	2400 x 596
535 x 296	1735 x 296	
535 x 396	1735 x 396	
535 x 446	1735 x 446	
535 x 496	1735 x 496	
535 x 596	1735 x 596	
650 x 296	2150 x 296	

Non-Standard Bedroom Door Sizes - Priced next door size up.

Maximum Height MTM - 2400mm (H).

Maximum Width MTM - 1200mm (W).

Curved Bedroom Doors Not Available.

Concave Bedroom Doors Not Available.

Bedroom Frames Not Available.

Angled Bedroom Door Sizes - Priced as door size plus 50%.

Letterbox Routing - Priced as door size plus 4%.

Drilling - Additional charge per hole.

Tribeca | Handleless Rail System Door Sizes



Plain Panel
(18mm thick)

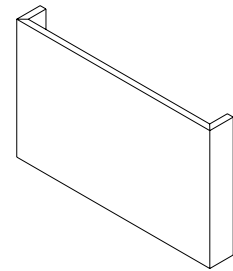

Cloaking End Panel
80mm Minimum End Width



See page 240 for order form

Handleless Rail System Door Sizes

Kitchen Door Sizes



Bedroom Door Sizes



160 x 296	490 x 296	1400 x 263	1500 x 413	2150 x 563
160 x 396	490 x 396	1400 x 281	1500 x 431	2150 x 581
160 x 446	490 x 446	1400 x 313	1500 x 463	2250 x 263
160 x 496	490 x 496	1400 x 331	1500 x 481	2250 x 281
160 x 596	490 x 596	1400 x 363	1500 x 513	2250 x 313
160 x 796	685 x 146	1400 x 381	1500 x 531	2250 x 331
160 x 896	685 x 296	1400 x 413	1500 x 563	2250 x 363
160 x 996	685 x 315	1400 x 431	1500 x 581	2250 x 381
325 x 496	685 x 346	1400 x 463	2150 x 263	2250 x 413
325 x 596	685 x 396	1400 x 481	2150 x 281	2250 x 431
325 x 796	685 x 446	1400 x 513	2150 x 313	2250 x 463
325 x 896	685 x 496	1400 x 531	2150 x 331	2250 x 481
325 x 996	685 x 596	1400 x 563	2150 x 363	2250 x 513
		1400 x 581	2150 x 381	2250 x 531
		1500 x 263	2150 x 413	2250 x 563
		1500 x 281	2150 x 431	2250 x 581
		1500 x 313	2150 x 463	
		1500 x 331	2150 x 481	
		1500 x 363	2150 x 513	
		1500 x 381	2150 x 531	

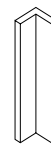

Internal Corner Post
685 x 70 x 70mm



External Corner Post
685 x 46 x 46mm



See page 236 for Handleless Rail System Kitchen and Bedroom Matrix.
Drilling - Additional charge per hole.

Save time & money with **automatic pricing** through our online ordering service.



Order online at weborders.osdoors.com

Important: Always ensure doors are shielded from heat sources through the use of heat deflectors.

See page 226 for full range of heat deflector sizes.



Tribeca | Door Specifications

Edged | MTM

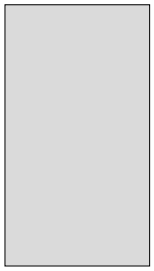

Tribeca Kitchen Door

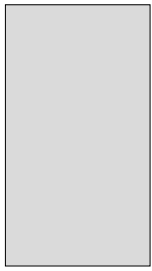

Tribeca Door with Integrated Handle (Top Edge - Maximum Width 1196mm)



Tribeca Door with Integrated Handle (Side Edge - Maximum Height 1196mm)

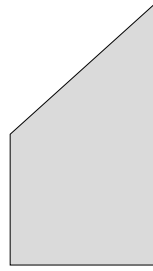

Tribeca Angled Door



Tribeca Drawer



Tribeca Drawer with Integrated Handle (Top Edge - Maximum Width 1196mm)



Tribeca Pan Drawer



Tribeca Pan Drawer with Integrated Handle (Top Edge - Maximum Width 1196mm)

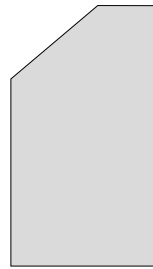

Tribeca Angled Flat Top Door



Tribeca Bedroom Door

Tribeca | Technical Specifications

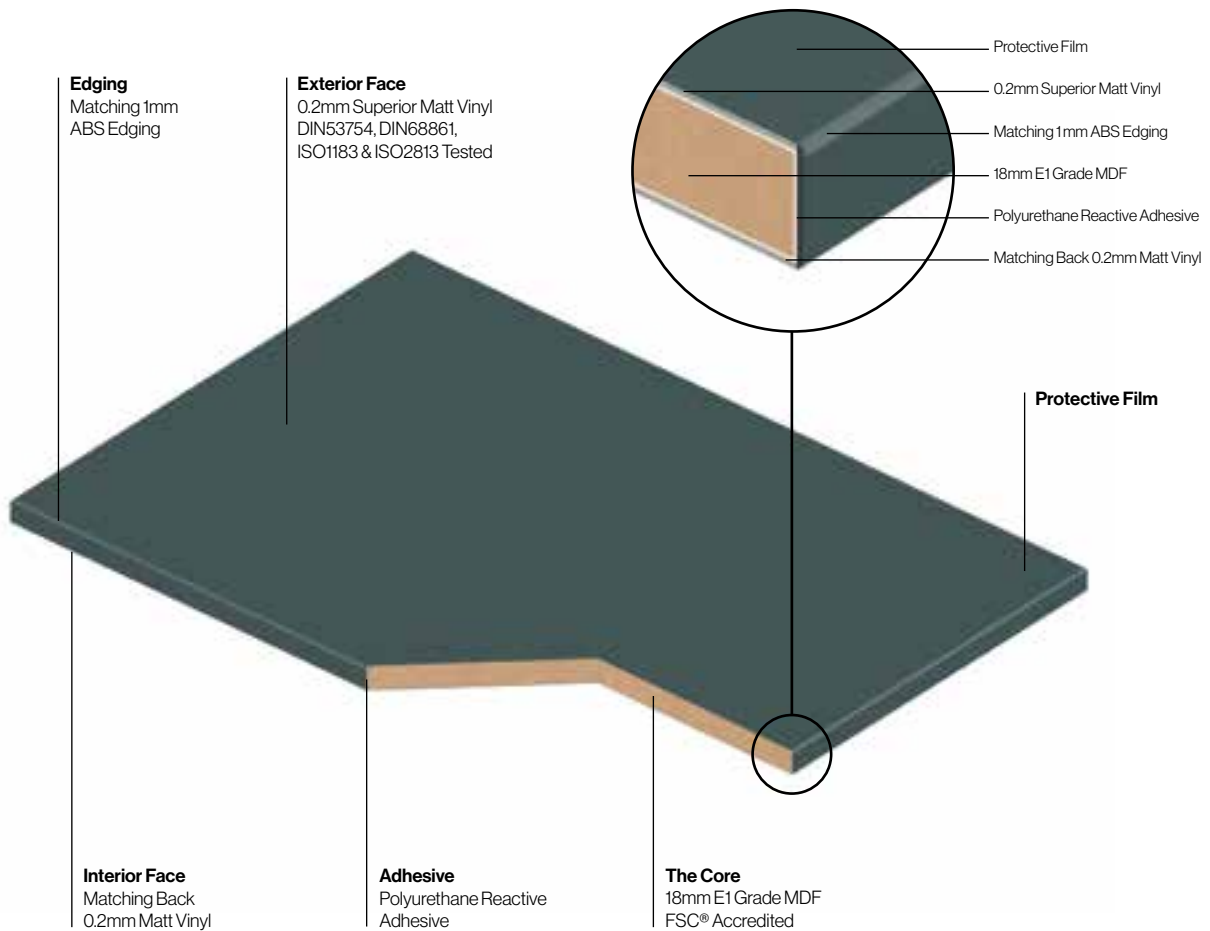

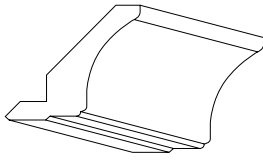

Classic Cornice
76mm (W) x 63mm (H)
3050mm Lengths



Not available in Superior Matt Black

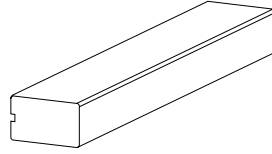

Modern Cornice / Pelmet
50mm (W) x 30mm (H)
3050mm Lengths

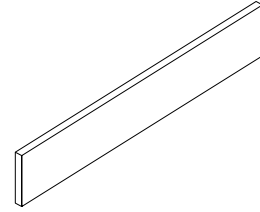

Plain Plinth
18mm (W) x 150mm (H)
2400mm Lengths

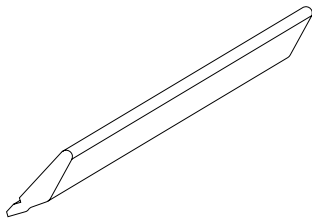

Tangent Cornice
72mm (W) x 44mm (H)
3050mm Lengths



Not available in Superior Matt Black

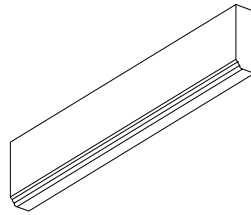

Tangent Pelmet
18mm (W) x 57mm (H)
3050mm Lengths



Not available in Superior Matt Black or Superior Matt Marine Blue

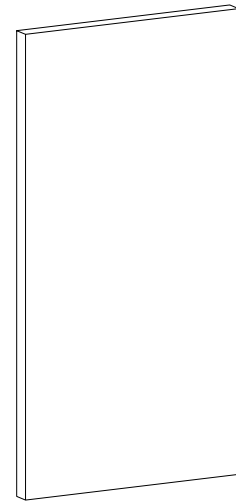

Plain Panel
18mm Thick
Supplied Cut & 1mm Edged

Standard Sizes MM:
785 x 360mm
900 x 650mm
900 x 1200mm
965 x 360mm
2400 x 360mm
2400 x 650mm

Made to Measure per m2



Corner Post
715mm (150 x 150mm Max)

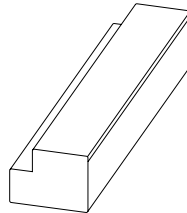

Square Base Pilaster
70mm (W) x 50mm (H)
3050mm Lengths



Not available in Superior Matt Black or Superior Matt Indigo



Available Ex.Stock (Limited Finishes).
Ready for same day despatch.



Available Made to Measure.
Ready for despatch in 5 working days.

Vaasa | Cut and Edged MFC Doors

Edged | MTM



Featured in Ethos Edged Brochure

Door Specification

Description	Flat Bonded Melamine Door
Finish	Available in a range of Gloss, Smooth Matt and Tactile Finishes
Door Thickness	18mm Thick
Base Material	MFC Core
Special Features	High Scratch Resistance and Highly Durable Core
Edge	Matching 0.8mm ABS Edging.



Available Made to Measure



24 MFC Finishes



Embossed Textures



Integrated Handle Options



High Scratch Resistance



Vaasa | Colours / Finishes

Material Effect / Available MTM



Sand Grey Halifax Oak
H1336 ST37



White Halifax Oak
H1176 ST37



Shorewood
H3090 ST22



Natural Halifax Oak
H1180 ST37



Natural Kendal Oak
H3170 ST12



Urban Oak
K005PW



Grey Bardolino Oak
H1146 ST10



Lincoln Walnut
H1714 ST19



Sepia Gladstone Oak
H3342 ST28
While Stock Lasts

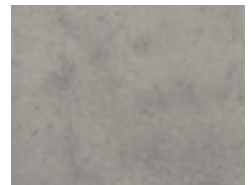

Light Grey Concrete
F186 ST9



Anthracite Metal Fabric
F461 ST10
While Stock Lasts

Matt / Available MTM

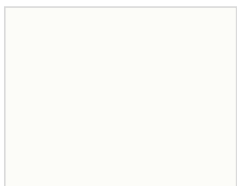

Premium White
W1000 ST9

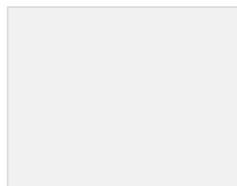

Porcelain
W1200 ST9

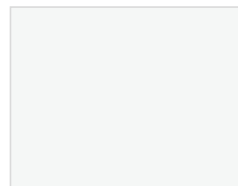

White Grey
U775 ST9

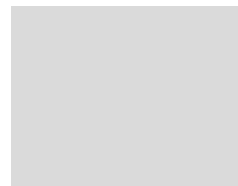

Light Grey
U708 ST9



Dust Grey
U732 ST9

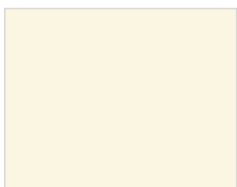

Alabaster
U104 ST9



Pebble
U201 ST9

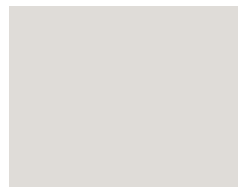

Taupe Grey
U750 ST9



Cashmere Grey
U702 ST9



Stone Grey
U727 ST9



Denim Blue
U540 ST9



Indigo Blue
U599 ST9



Fir Green (Evergreen)
U699 ST9

Vaasa | Door and Drawer Sizes



Kitchen Door Sizes

Doors and Drawer Sizes MTM

115 x 596	355 x 496	715 x 546
140 x 296	355 x 596	715 x 596
140 x 396	355 x 796	895 x 296
140 x 446	355 x 896	895 x 396
140 x 496	355 x 996	895 x 446
140 x 596	450 x 596	895 x 496
140 x 796	500 x 596	895 x 596
140 x 896	570 x 296	980 x 596
140 x 996	570 x 396	1060 x 396
175 x 396	570 x 446	1060 x 496
175 x 496	570 x 496	1060 x 596
175 x 596	570 x 596	1245 x 296
175 x 796	715 x 146	1245 x 396
175 x 896	715 x 246	1245 x 446
175 x 996	715 x 296	1245 x 496
283 x 496	715 x 313	1245 x 596
283 x 596	715 x 346	
283 x 796	715 x 396	
283 x 896	715 x 446	
283 x 996	715 x 496	

Non-Standard Kitchen Door Sizes - Priced next door size up.

Maximum Height MTM - 2750mm (H).

Maximum Width MTM - 2000mm (W).

Horizontal Grain - Priced as door size plus 20%.

Curved Kitchen Doors Not Available.

Concave Kitchen Doors Not Available.

Kitchen Frames Not Available.

Angled Kitchen Door Sizes - Priced as door size plus 50%.

Zenith Handle Rebate - Priced as door size plus 7.5%.

Letterbox Routers - Priced as door size plus 4%.

Drilling - Additional charge per hole.

Bedroom Door Sizes

Doors and Drawer Sizes MTM

215 x 296	650 x 396	2150 x 396
215 x 396	650 x 446	2150 x 446
215 x 446	650 x 496	2150 x 496
215 x 496	650 x 596	2150 x 596
215 x 546	1495 x 296	2250 x 296
215 x 596	1495 x 396	2250 x 396
215 x 796	1495 x 446	2250 x 446
215 x 896	1495 x 496	2250 x 496
215 x 996	1495 x 596	2250 x 596
415 x 296	1595 x 296	2400 x 296
415 x 396	1595 x 396	2400 x 396
415 x 446	1595 x 446	2400 x 446
415 x 496	1595 x 496	2400 x 496
415 x 596	1595 x 596	2400 x 596
535 x 296	1735 x 296	
535 x 396	1735 x 396	
535 x 446	1735 x 446	
535 x 496	1735 x 496	
535 x 596	1735 x 596	
650 x 296	2150 x 296	

Non-Standard Bedroom Door Sizes - Priced next door size up.

Maximum Height MTM - 2750mm (H).

Maximum Width MTM - 2000mm (W).

Horizontal Grain - Priced as door size plus 20%.

Curved Bedroom Doors Not Available.

Concave Bedroom Doors Not Available.

Bedroom Frames Not Available.

Angled Bedroom Door Sizes - Priced as door size plus 50%.

Letterbox Routers - Priced as door size plus 4%.

Drilling - Additional charge per hole.

Vaasa | Handleless Rail System Door Sizes



Plain Panel
(18mm thick)

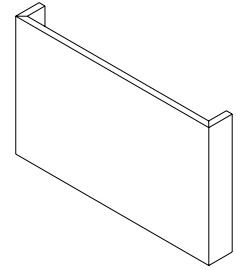

Cloaking End Panel
80mm Minimum End Width



See page 240 for order form

Handleless Rail System Door Sizes

Kitchen Door Sizes



Bedroom Door Sizes



160 x 296	490 x 296	1400 x 263	1500 x 413	2150 x 563
160 x 396	490 x 396	1400 x 281	1500 x 431	2150 x 581
160 x 446	490 x 446	1400 x 313	1500 x 463	2250 x 263
160 x 496	490 x 496	1400 x 331	1500 x 481	2250 x 281
160 x 596	490 x 596	1400 x 363	1500 x 513	2250 x 313
160 x 796	685 x 146	1400 x 381	1500 x 531	2250 x 331
160 x 896	685 x 296	1400 x 413	1500 x 563	2250 x 363
160 x 996	685 x 315	1400 x 431	1500 x 581	2250 x 381
325 x 496	685 x 346	1400 x 463	2150 x 263	2250 x 413
325 x 596	685 x 396	1400 x 481	2150 x 281	2250 x 431
325 x 796	685 x 446	1400 x 513	2150 x 313	2250 x 463
325 x 896	685 x 496	1400 x 531	2150 x 331	2250 x 481
325 x 996	685 x 596	1400 x 563	2150 x 363	2250 x 513
		1400 x 581	2150 x 381	2250 x 531
		1500 x 263	2150 x 413	2250 x 563
		1500 x 281	2150 x 431	2250 x 581
		1500 x 313	2150 x 463	
		1500 x 331	2150 x 481	
		1500 x 363	2150 x 513	
		1500 x 381	2150 x 531	



Internal Corner Post
685 x 70 x 70mm



External Corner Post
685 x 46 x 46mm



Drilling - Additional charge per hole.

Compatible with
the integrated
Zenith Handle

See page 232 for sizes and
technical specifications.



Save time & money with **automatic pricing**
through our online ordering service.



Order online at weborders.osdoors.com

Important: Always ensure doors are
shielded from heat sources through
the use of heat deflectors.

See page 226 for full range of heat deflector sizes.



Vaasa | Door Specifications

Edged | MTM

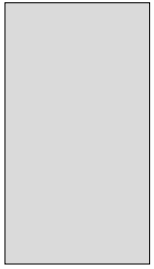

Vaasa Kitchen Door

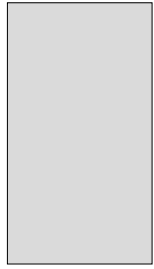

Vaasa Door with Integrated Handle (Top Edge - Maximum Width 1196mm)

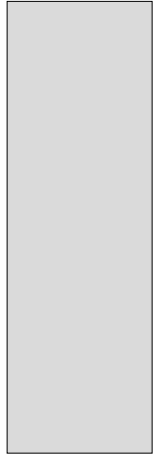

Vaasa Door with Integrated Handle (Side Edge - Maximum Height 1196mm)

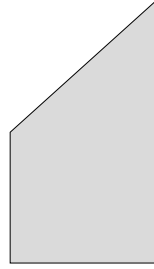

Vaasa Angled Door



Vaasa Bedroom Door



Vaasa Drawer



Vaasa Drawer with Integrated Handle (Top Edge - Maximum Width 1196mm)



Vaasa Pan Drawer



Vaasa Pan Drawer with Integrated Handle (Top Edge - Maximum Width 1196mm)

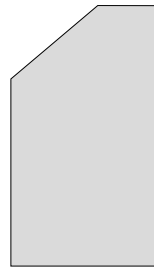

Vaasa Angled Flat Top Door

Vaasa | Technical Specifications

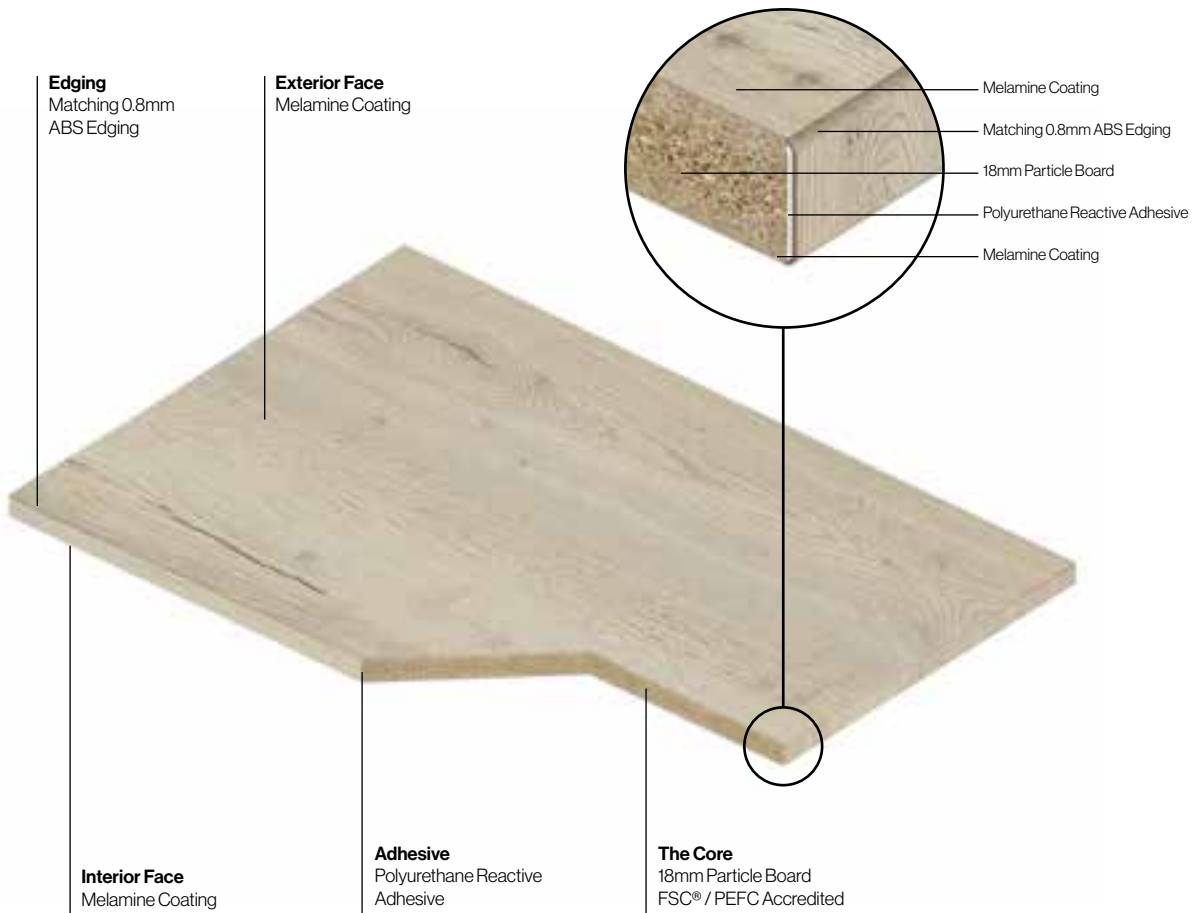

Vaasa | Accessories

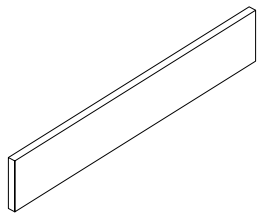

Plain Plinth
18mm (W) x 150mm (H)
2400mm Lengths

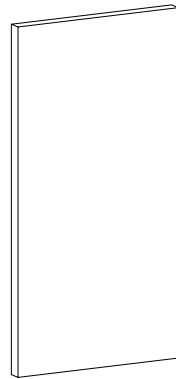

Plain Panel
18mm Thick
Supplied Cut & 1mm Edged

Standard Sizes MM:
785 x 360mm
900 x 650mm
900 x 1200mm
965 x 360mm
2400 x 360mm
2400 x 650mm

Made to Measure per m2



Vaasa Kitchen Featured in Shorewood H3090 ST22



Available Made to Measure.
Ready for despatch in 5 working days.

Mather | Cut and Edged Legno Doors

Edged | MTM



Featured in Ethos Edged Brochure

Door Specification

Description	Flat Bonded Melamine Door
Finish	Available in a range of Uni-Colour, Legno Grain Embossed Finishes.
Door Thickness	18mm Thick
Base Material	MFC Core
Special Features	Tactile Surface
Edge	Matching 1mm ABS Edge.



Available Made to Measure



12 Legno Finishes



Embossed Texture



Integrated Handle Options



Mather | Colours / Finishes



Legno White

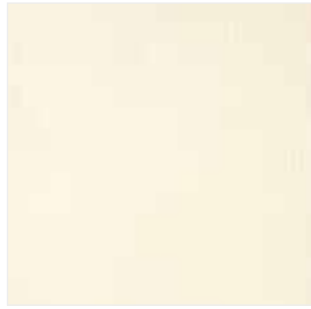

Legno Ivory



Legno Mussel



Legno Taupe



Legno Cashmere



Legno White Grey



Legno Light Grey



Legno Dust Grey



Legno Graphite

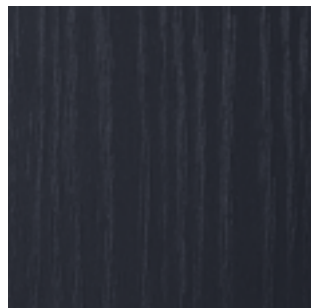

Legno Indigo



Legno Evergreen



Legno Black

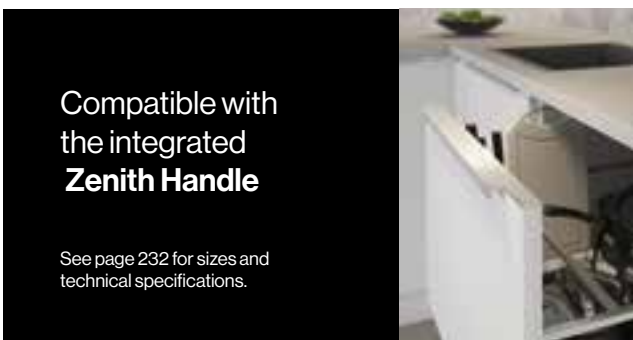

Mather | Door and Drawer Sizes



Kitchen Door Sizes

Doors and Drawer Sizes



115 x 596	355 x 496	715 x 546
140 x 296	355 x 596	715 x 596
140 x 396	355 x 796	895 x 296
140 x 446	355 x 896	895 x 396
140 x 496	355 x 996	895 x 446
140 x 596	450 x 596	895 x 496
140 x 796	500 x 596	895 x 596
140 x 896	570 x 296	980 x 596
140 x 996	570 x 396	1060 x 396
175 x 396	570 x 446	1060 x 496
175 x 496	570 x 496	1060 x 596
175 x 596	570 x 596	1245 x 296
175 x 796	715 x 146	1245 x 396
175 x 896	715 x 246	1245 x 446
175 x 996	715 x 296	1245 x 496
283 x 496	715 x 313	1245 x 596
283 x 596	715 x 346	
283 x 796	715 x 396	
283 x 896	715 x 446	
283 x 996	715 x 496	

Non-Standard Kitchen Door Sizes - Priced next door size up.

Maximum Height MTM - 2750mm (H).

Maximum Width MTM - 2000mm (W).

Horizontal Grain - Priced as door size plus 20%.

Curved Kitchen Doors Not Available.

Concave Kitchen Doors Not Available.

Kitchen Frames Not Available.

Angled Kitchen Door Sizes - Priced as door size plus 50%.

Zenith Handle Rebate - Priced as door size plus 7.5%.

Letterbox Routers - Priced as door size plus 4%.

Drilling - Additional charge per hole.



Bedroom Door Sizes

Doors and Drawer Sizes



215 x 296	650 x 396	2150 x 396
215 x 396	650 x 446	2150 x 446
215 x 446	650 x 496	2150 x 496
215 x 496	650 x 596	2150 x 596
215 x 546	1495 x 296	2250 x 296
215 x 596	1495 x 396	2250 x 396
215 x 796	1495 x 446	2250 x 446
215 x 896	1495 x 496	2250 x 496
215 x 996	1495 x 596	2250 x 596
415 x 296	1595 x 296	2400 x 296
415 x 396	1595 x 396	2400 x 396
415 x 446	1595 x 446	2400 x 446
415 x 496	1595 x 496	2400 x 496
415 x 596	1595 x 596	2400 x 596
535 x 296	1735 x 296	
535 x 396	1735 x 396	
535 x 446	1735 x 446	
535 x 496	1735 x 496	
535 x 596	1735 x 596	
650 x 296	2150 x 296	

Non-Standard Bedroom Door Sizes - Priced next door size up.

Maximum Height MTM - 2750mm (H).

Maximum Width MTM - 2000mm (W).

Horizontal Grain - Priced as door size plus 20%.

Curved Bedroom Doors Not Available.

Concave Bedroom Doors Not Available.

Bedroom Frames Not Available.

Angled Bedroom Door Sizes - Priced as door size plus 50%.

Letterbox Routers - Priced as door size plus 4%.

Drilling - Additional charge per hole.



Mather | Handleless Rail System Door Sizes



Plain Panel
(18mm thick)

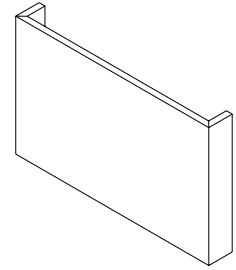

Cloaking End Panel
80mm Minimum End Width



See page 240 for order form

Handleless Rail System Door Sizes

Kitchen Door Sizes



Bedroom Door Sizes



160 x 296	490 x 296	1400 x 263	1500 x 413	2150 x 563
160 x 396	490 x 396	1400 x 281	1500 x 431	2150 x 581
160 x 446	490 x 446	1400 x 313	1500 x 463	2250 x 263
160 x 496	490 x 496	1400 x 331	1500 x 481	2250 x 281
160 x 596	490 x 596	1400 x 363	1500 x 513	2250 x 313
160 x 796	685 x 146	1400 x 381	1500 x 531	2250 x 331
160 x 896	685 x 296	1400 x 413	1500 x 563	2250 x 363
160 x 996	685 x 315	1400 x 431	1500 x 581	2250 x 381
325 x 496	685 x 346	1400 x 463	2150 x 263	2250 x 413
325 x 596	685 x 396	1400 x 481	2150 x 281	2250 x 431
325 x 796	685 x 446	1400 x 513	2150 x 313	2250 x 463
325 x 896	685 x 496	1400 x 531	2150 x 331	2250 x 481
325 x 996	685 x 596	1400 x 563	2150 x 363	2250 x 513
		1400 x 581	2150 x 381	2250 x 531
		1500 x 263	2150 x 413	2250 x 563
		1500 x 281	2150 x 431	2250 x 581
		1500 x 313	2150 x 463	
		1500 x 331	2150 x 481	
		1500 x 363	2150 x 513	
		1500 x 381	2150 x 531	



Internal Corner Post
685 x 70 x 70mm



External Corner Post
685 x 46 x 46mm



Drilling - Additional charge per hole.

Save time & money with **automatic pricing** through our online ordering service.



Order online at weborders.osdoors.com

Important: Always ensure doors are shielded from heat sources through the use of heat deflectors.

See page 226 for full range of heat deflector sizes.



Mather | Door Specifications

Edged | MTM

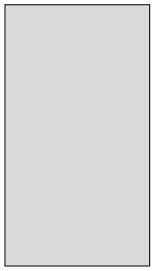

Mather Kitchen Door

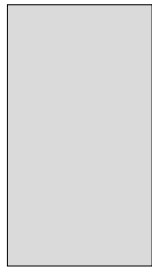

Mather Door with Integrated Handle (Top Edge - Maximum Width 1196mm)



Mather Door with Integrated Handle (Side Edge - Maximum Height 1196mm)

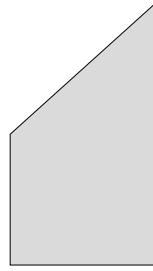

Mather Angled Door



Mather Drawer



Mather Drawer with Integrated Handle (Top Edge - Maximum Width 1196mm)



Mather Pan Drawer



Mather Pan Drawer with Integrated Handle (Top Edge - Maximum Width 1196mm)

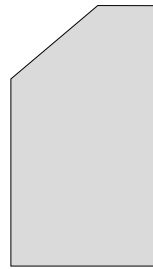

Mather Angled Flat Top Door



Mather Bedroom Door

Mather | Technical Specifications

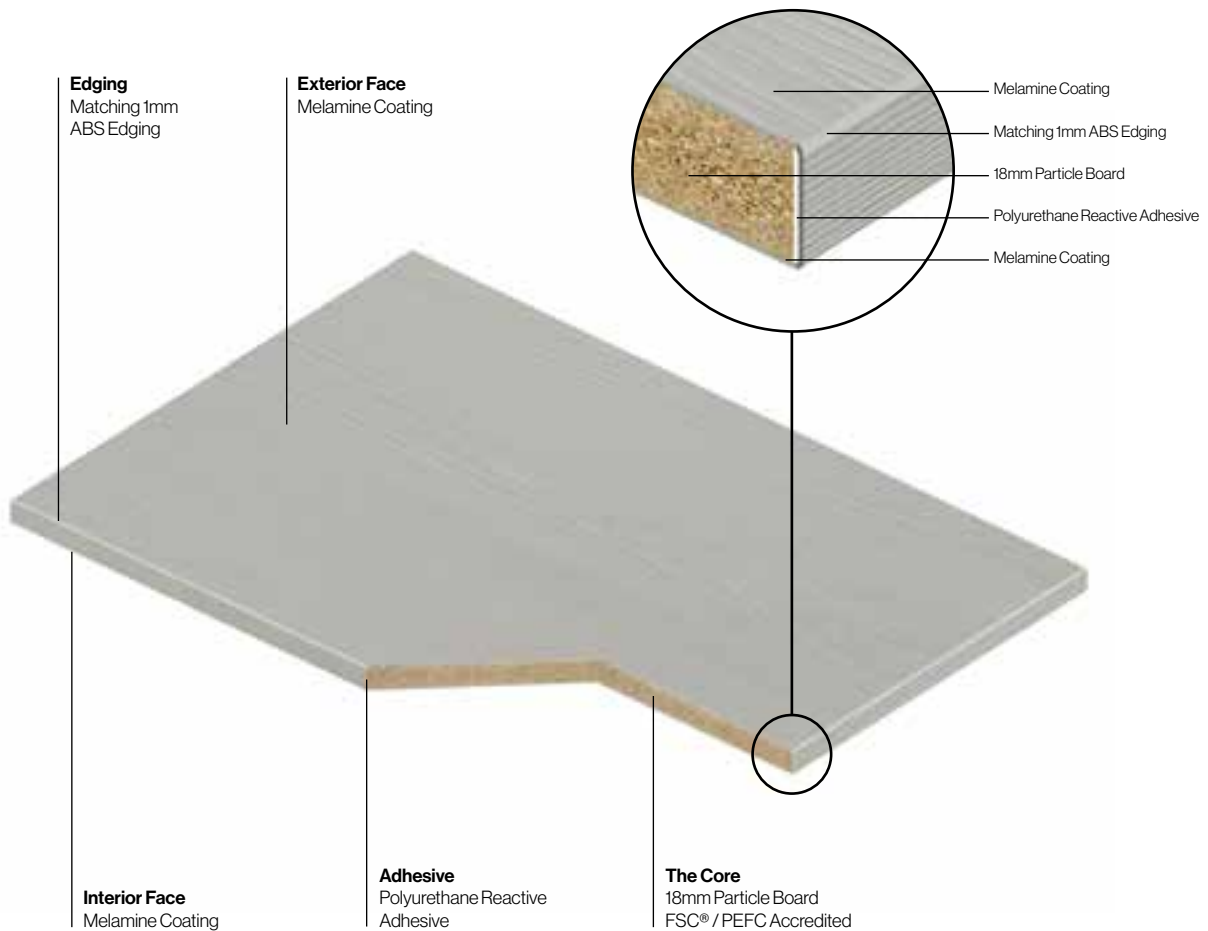

Mather | Accessories

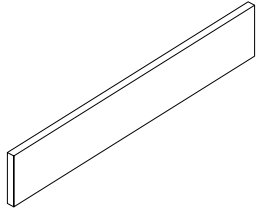

Plain Plinth
18mm (W) x 150mm (H)
2500mm Lengths

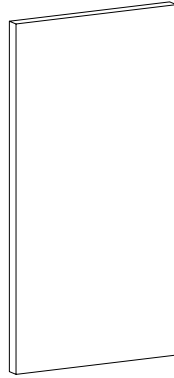

Plain Panel
18mm Thick
Supplied Cut & 1mm Edged

Standard Sizes MM:
785 x 360mm
900 x 650mm
900 x 1200mm
965 x 360mm
2400 x 360mm
2400 x 650mm

Made to Measure per m2



Wide Colour Choice. MTM Flexibility. Crafted Aesthetic. Choose MDF Painted.



Our MDF Painted Collection has been carefully selected to provide you with the most sought after door styles and colours. We only use the best quality, highest performing and durable paints to ensure you get colour that lasts.



Arena
MDF Matt Painted (Smooth)
Page 118



Parker
MDF Matt Painted (Smooth)
Page 124



Hartford
MDF Matt Painted (Smooth)
Page 130



Wellington
MDF Matt Painted (Smooth)
Page 138



Belair
MDF Matt Painted (Smooth)
Page 146



Gladstone
MDF Matt Painted (Smooth)
Page 154



MDF Painted

Arena | MDF Matt Painted (Smooth)

MDF Painted | Ex,Stock and MTM



Door Specification

Description	J-Pull Handleless Door with 40mm Deep Handle Cavity
Finish	Smooth Matt Painted Finish
Door Thickness	22mm Thick
Base Material	MDF Core



4 Ex. Stock Colours



31 Painted Colours



Available Painted to Order standard sizes.



Available Made to Measure Unfinished Only*



Available Primed / Unfinished*

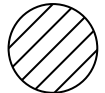

Smooth Surface



Arena | Colours / Finishes

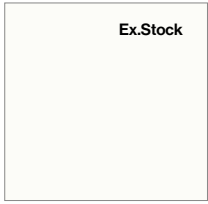

Primed



White

Colours swatches shown are approximate.

See Painted Swatch Book for true colour match.

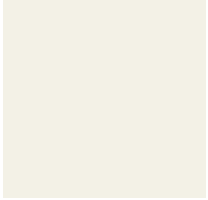

Porcelano

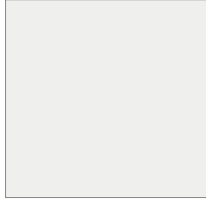

Highland Grey

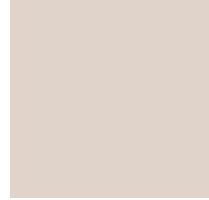

Cashmere



Sea Breeze

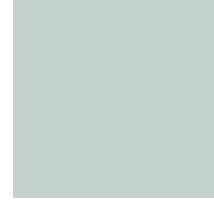

Light Blue

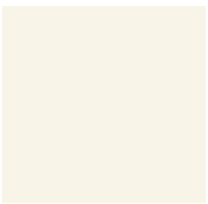

Ivory



Light Grey

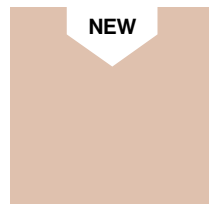

French Chalk



Sage



Denim

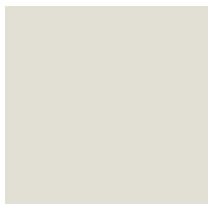

Mussel



Dust Grey



Heritage Pink



Liberty Green



Eiffel Blue



Dakar

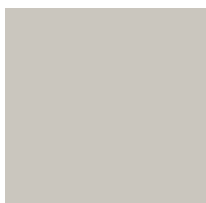

Pebble

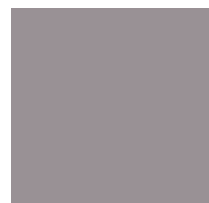

French Lavender



Moss Green



Nautical

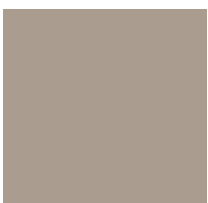

Stone Grey

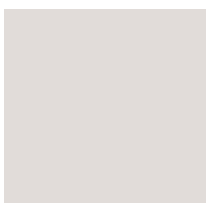

Taupe Grey

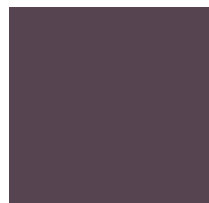

Foraged Fruit



Heritage Green



Marine Blue



Honeycomb



Graphite



Heritage Red

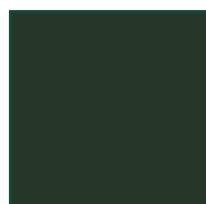

Conifer



Indigo

Arena | Door Specifications

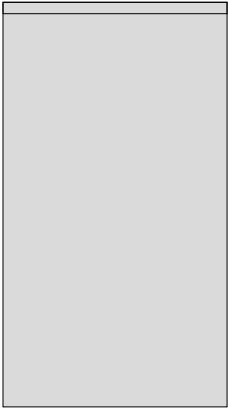

Arena Kitchen Door

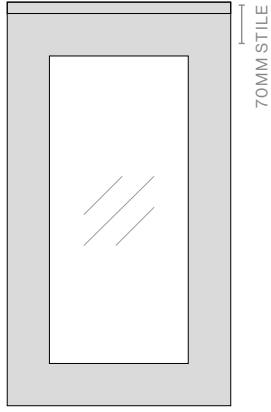

Arena Kitchen Frame (Glazed)

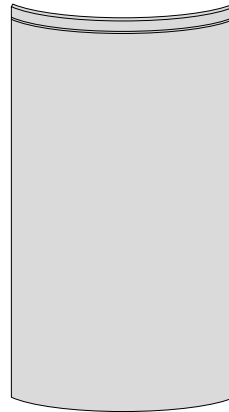

Arena Kitchen Curved Door

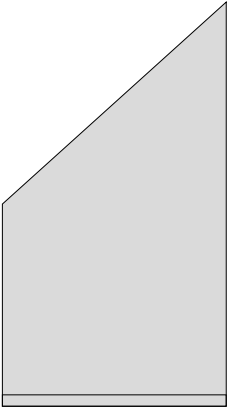

Arena Angled Kitchen Door

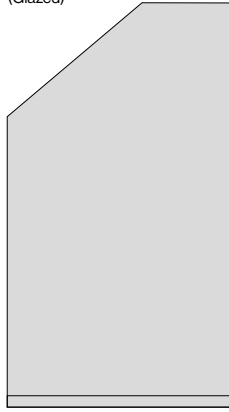

Arena Angled Flat Top Door

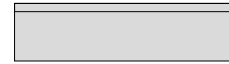

Arena Drawer

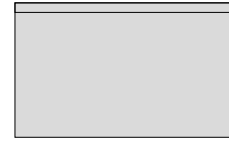

Arena Pan Drawer

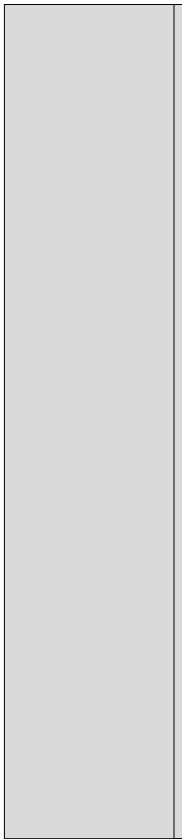

Arena Bedroom Door

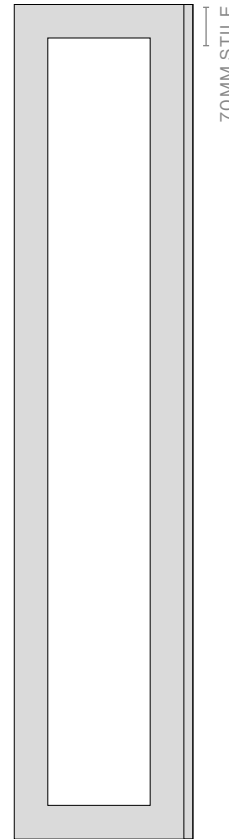

Arena Bedroom Frame (Unglazed)

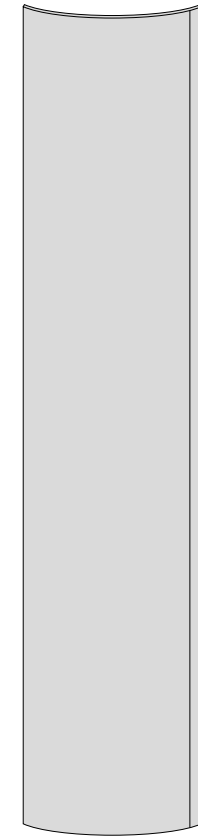

Arena Bedroom Curved Door

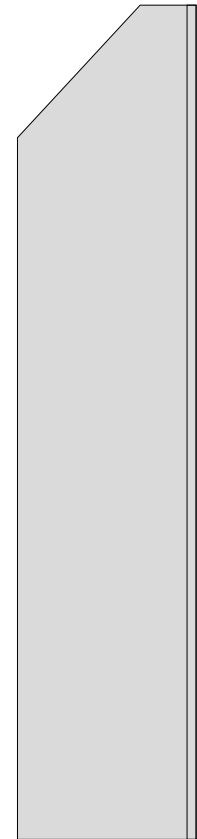

Arena Angled Flat Top Bedroom Door





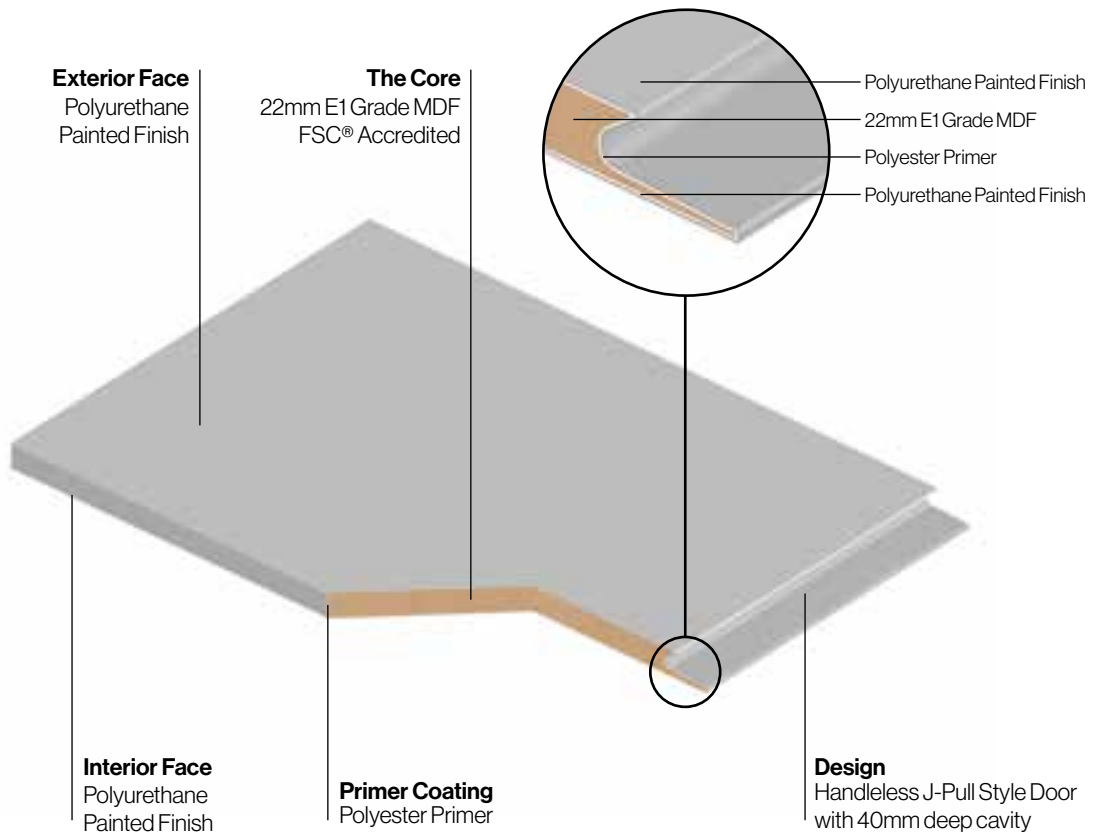

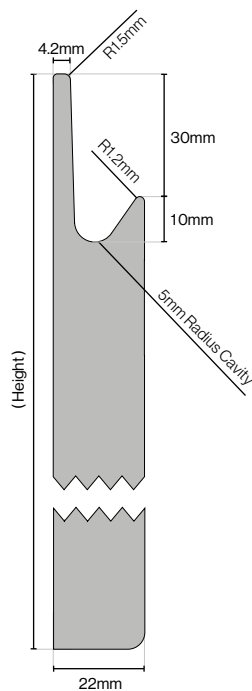

Arena | Technical Specifications

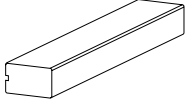
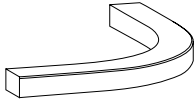
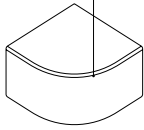
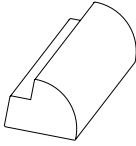
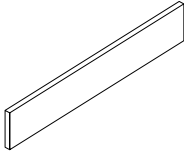
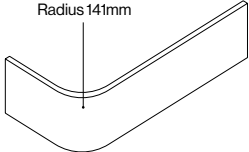
MDF Painted | Ex.Stock and MTM

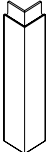

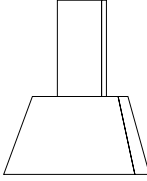
**Arena Door
Cross Section**

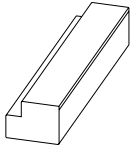
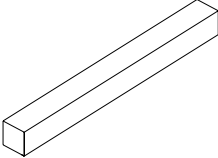
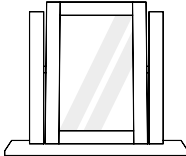

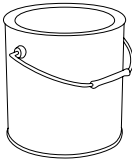
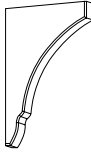
 <p>Modern Cornice / Pelmet 50mm (W) x 30mm (H) 3050mm Lengths</p> <p>EXS PTO</p>	 <p>Curved Modern Cornice / Pelmet 350mm (L) x 350mm (W) x 30mm (H)</p> <p>EXS PTO</p>	 <p>Radius 50mm</p> <p>Modern Cornice / Pelmet Quadrant 50mm (L) 50mm (W) x 30mm (H)</p> <p>EXS PTO</p>	 <p>Radius Profile (Radius 48mm) 70mm (W) x 50mm (H) 3050mm Lengths</p> <p>EXS PTO</p>
 <p>Plain Plinth 18mm (W) x 150mm (H) 3050mm Lengths</p> <p>EXS PTO</p>	 <p>Radius 141mm</p> <p>Curved Plain Plinth 540mm (L) x 232mm (W) x 150mm (H)</p> <p>EXS PTO</p>	 <p>Internal J-Pull Corner Post 70mm (L) x 70mm (W) x 715mm (H)</p> <p>EXS PTO</p>	 <p>External J-Pull Corner Post 75mm (L) x 75mm (W) x 965mm (H)</p> <p>EXS PTO</p>
 <p>Corner Post 30mm (L) x 30mm (W) x 720mm (H)</p> <p>EXS PTO</p>	 <p>MTM Corner Post 715mm (150 x 150mm Max)</p> <p>MTM</p>	 <p>Chimney Canopy 900mm (W) x 400mm (D) x 1130mm (H)</p> <p>PTO</p>	 <p>Plain Panel - Standard Sizes 18mm / 785 x 360mm 18mm / 900 x 650mm 18mm / 900 x 864mm 18mm / 900 x 1160mm 18mm / 900 x 1200mm 18mm / 965 x 360mm 18mm / 2400 x 360mm 18mm / 2400 x 650mm 18mm / 2400 x 900mm</p> <p>EXS PTO</p>
 <p>Square Base Pilaster 965mm (L) x 70mm (W) x 50mm (H) Also available in 3050mm lengths</p> <p>EXS PTO</p>	 <p>Square Base Pilaster Insert 965mm (L) x 18mm (W) x 18mm (H)</p> <p>EXS PTO</p>	 <p>Single Square Mirror 485mm (W) x 570mm (H)</p> <p>PTO</p>	<p>Plain Panel - Non Standard Sizes 18mm Thick / MTM per m2 22mm Thick / MTM per m2</p> <p>MTM</p>
 <p>Headboard MTM per m2. / Supplied as a flat panel</p> <p>MTM</p>		 <p>Touch Up Paint Available 30ml or 1 Litre volumes.</p>	 <p>Shelf Bracket 100mm (L) x 18mm (W) x 150mm (H)</p> <p>EXS PTO</p>

Parker | MDF Matt Painted Door (Smooth)

MDF Painted | Ex.Stock and MTM



Door Specification

Description	Plain Shaker Style Door with 60mm Stiles and Rails
Finish	Smooth Matt Painted Finish
Door Thickness	18mm Thick
Base Material	MDF Core



31 Painted Colours



Available Painted to Order standard sizes.



Available Made to Measure Unfinished Only*



Available Primed / Unfinished*

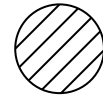

Smooth Surface



Parker | Colours / Finishes

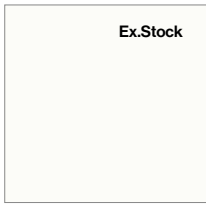

Primed

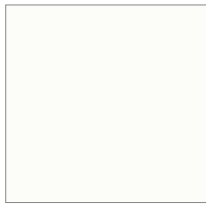

White

Colours swatches shown are approximate.

See Painted Swatch Book for true colour match.

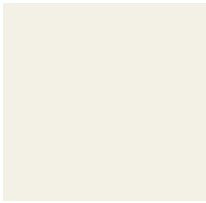

Porcelano



Highland Grey



Cashmere



Sea Breeze



Light Blue

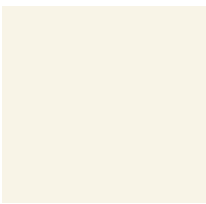

Ivory

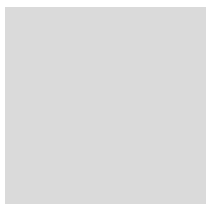

Light Grey



French Chalk



Sage



Denim

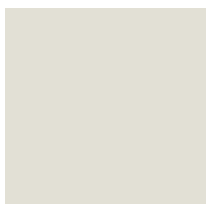

Mussel

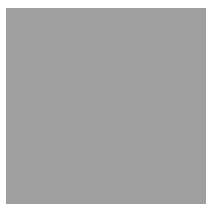

Dust Grey

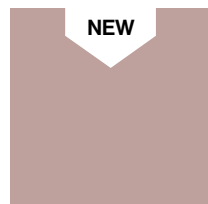

Heritage Pink



Liberty Green



Eiffel Blue



Dakar

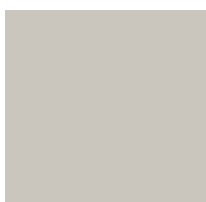

Pebble

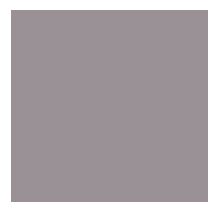

French Lavender



Moss Green



Nautical



Stone Grey

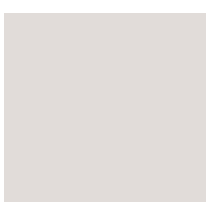

Taupe Grey



Foraged Fruit



Heritage Green



Marine Blue



Honeycomb



Graphite



Heritage Red



Conifer



Indigo

MDF Painted | Ex.Stock and MTM

Parker | Door and Drawer Sizes

MDF Painted | Ex:Stock and MTM



Kitchen Door Sizes							
Doors Sizes		PTO	MTM	Curved Door Sizes		PTO	MTM
115 x 596	570 x 446			715 x 300			
140 x 296	570 x 496						
140 x 396	570 x 596						
140 x 446	645 x 596						
140 x 496	715 x 146						
140 x 596	715 x 246						
140 x 796	715 x 275						
140 x 896	715 x 296						
140 x 996	715 x 315						
175 x 396	715 x 346						
175 x 496	715 x 396						
175 x 596	715 x 446						
283 x 496	715 x 496						
283 x 596	715 x 546						
283 x 796	715 x 596						
283 x 896	895 x 296						
283 x 996	895 x 396						
355 x 496	895 x 446						
355 x 596	895 x 496						
355 x 760	895 x 596						
355 x 796	980 x 596						
355 x 896	1245 x 296						
355 x 996	1245 x 396						
450 x 596	1245 x 496						
495 x 396	1245 x 596						
495 x 596							
570 x 296							
570 x 396							
		PTO	MTM	Plain Frame Sizes		PTO	MTM
				355 x 496 (Glazed)			
				715 x 396 (Glazed)			
				715 x 496 (Glazed)			
				895 x 495 (Glazed)			
				1060 x 49 (Glazed)			

Bedroom Door Sizes					
Doors and Drawer Sizes		MTM	Curved Door Sizes		MTM
215 x 296	1495 x 596		1495 x 300		
215 x 396	1595 x 296		1595 x 300		
215 x 446	1595 x 396		2150 x 300		
215 x 496	1595 x 446		2250 x 300		
215 x 546	1595 x 496				
215 x 596	1595 x 596				
215 x 796	1735 x 296				
215 x 896	1735 x 396				
215 x 996	1735 x 446				
415 x 296	1735 x 496				
415 x 396	1735 x 596				
415 x 446	2150 x 296				
415 x 496	2150 x 396				
415 x 596	2150 x 446				
535 x 296	2150 x 496				
535 x 396	2150 x 596				
535 x 446	2250 x 296				
535 x 496	2250 x 396				
535 x 596	2250 x 446				
650 x 296	2250 x 496				
650 x 396	2250 x 596				
650 x 446	2400 x 296				
650 x 496	2400 x 396				
650 x 596	2400 x 446				
1495 x 296	2400 x 496				
1495 x 396	2400 x 596				
1495 x 446					
1495 x 496					

Non-Standard Kitchen Door Sizes - Priced next door size up.

Angled Kitchen Door Sizes - Priced as door size plus 50%.

Primed MTM Sizes are not available.

***Unfinished MTM** - These doors will be supplied as raw MDF.

Curved Kitchen Doors available any height up to 2250mm

Non-Standard Curved Kitchen Door Sizes - Priced next door size up.

Standard Kitchen Frame Sizes - Supplied Glazed.

MTM Plain Kitchen Frames - Priced as door size plus 35% (Supplied Unglazed).

Drilling - Additional charge per hole.

Non-Standard Bedroom Door Sizes - Priced next door size up.

Angled Bedroom Door Sizes - Priced as door size plus 50%.

Primed MTM Sizes are not available.

***Unfinished MTM** - These doors will be supplied as raw MDF.

Curved Bedroom Doors available any height up to 2250mm

Non-Standard Curved Bedroom Door Sizes - Priced next door size up.

MTM Plain Bedroom Frames - Priced as door size plus 35% (Supplied Unglazed).

Drilling - Additional charge per hole.

Parker | Handleless Rail System Door Sizes



Plain Panel
(18mm thick)



Internal Corner Post
685 x 70 x 70mm



External Corner Post
685 x 46 x 46mm



MDF Painted | Ex:Stock and MTM

Handleless Rail System Door Sizes

Kitchen Door Sizes		Bedroom Door Sizes		
160 x 296	490 x 296	1400 x 263	1500 x 413	2150 x 563
160 x 396	490 x 396	1400 x 281	1500 x 431	2150 x 581
160 x 446	490 x 446	1400 x 313	1500 x 463	2250 x 263
160 x 496	490 x 496	1400 x 331	1500 x 481	2250 x 281
160 x 596	490 x 596	1400 x 363	1500 x 513	2250 x 313
160 x 796	685 x 146	1400 x 381	1500 x 531	2250 x 331
160 x 896	685 x 296	1400 x 413	1500 x 563	2250 x 363
160 x 996	685 x 315	1400 x 431	1500 x 581	2250 x 381
325 x 496	685 x 346	1400 x 463	2150 x 263	2250 x 413
325 x 596	685 x 396	1400 x 481	2150 x 281	2250 x 431
325 x 796	685 x 446	1400 x 513	2150 x 313	2250 x 463
325 x 896	685 x 496	1400 x 531	2150 x 331	2250 x 481
325 x 996	685 x 596	1400 x 563	2150 x 363	2250 x 513
		1400 x 581	2150 x 381	2250 x 531
		1500 x 263	2150 x 413	2250 x 563
		1500 x 281	2150 x 431	2250 x 581
		1500 x 313	2150 x 463	
		1500 x 331	2150 x 481	
		1500 x 363	2150 x 513	
		1500 x 381	2150 x 531	

Drilling - Additional charge per hole.

Save time & money with **automatic pricing** through our online ordering service.



Order online at weborders.osdoors.com

Important: Always ensure doors are shielded from heat sources through the use of heat deflectors.

See page 226 for full range of heat deflector sizes.



Parker | Door Specifications

MDF Painted | Ex:Stock and MTM

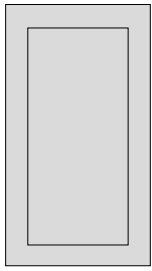

Parker Kitchen Door

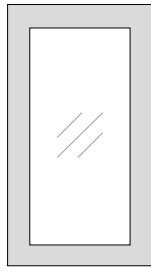

Parker Kitchen Frame (Glazed)

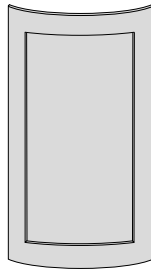

Parker Kitchen Curved Door



Parker Drawer

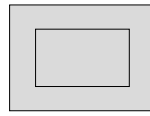

Parker Pan Drawer

Parker Kitchen Doors:

Kitchen Door sizes between 250mm - 1734mm high are supplied single panel as standard. Minimum Kitchen Door width is 246mm.

Parker Drawers:

Drawer sizes between 100mm - 282mm high are supplied as flat panels as standard. Minimum Drawer width is 246mm.

Pan Drawer sizes between 250mm - 282mm high are supplied as single panels as standard. Minimum Pan Drawer width is 246mm.

Please note it's important to specify either Door, Drawer or Pan Drawer when ordering to ensure your order is processed correctly.

Parker Frames:

Full Open Frames between 250mm - 1734mm high are supplied as single panel as standard.

Top Open Frames between 1735mm - 2400mm high are supplied with a double mid-rail which position is variable for each order (please specify required dimensions of split dimensions). The mid rail is measured from the base of the door to the centre of the mid rail unless otherwise specified.

It's important to specify either Full Open Frame or Top Open Frame when ordering to ensure your order is processed correctly.

Standard Kitchen Frame sizes are supplied glazed. Non standard Kitchen and Bedroom Frame sizes are supplied unglazed. Unglazed frames are rebated on the reverse side and supplied with a glazing gasket.

Angled Frames are not available.

Parker Curved Doors:

Curved doors are made to suit 300mm x 300mm cabinets only. Height availability ranges from 570mm up to 2250mm. Curved Door sizes between 1735mm - 2250mm high are supplied as 2 panel with a double mid-rail which position is variable for each order (please specify required dimensions of split dimensions).

The mid rail is measured from the base of the door to the centre of the mid rail unless otherwise specified. Minimum Curved Door width is 246mm.

Concave doors are not available.

Parker Bedroom Doors:

Bedroom Door sizes between 1735mm - 2400mm high are supplied as 2 panel with a double mid-rail which position is variable for each order (please specify required dimensions of split dimensions). The mid-rail is measured from the base of the door to the centre of the mid-rail unless otherwise specified.

If you require a 4 or 5 panel door this must be clearly stated when ordering. Both 4 and 5 panel doors will be supplied with single mid rails as standard.

Minimum Bedroom Door width is 246mm.

Drilling:

All door styles are supplied un-drilled unless requested by the customer. If drilling is required, drilling instructions must clearly state full dimensions for all holes required.

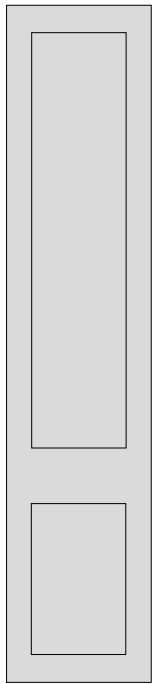

Parker Bedroom Door

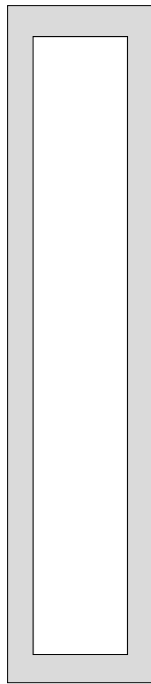

Parker Bedroom Full Open Frame (Unglazed)

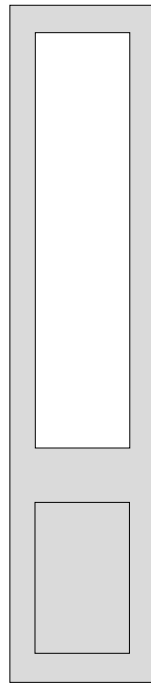

Parker Bedroom Top Open Frame (Unglazed)

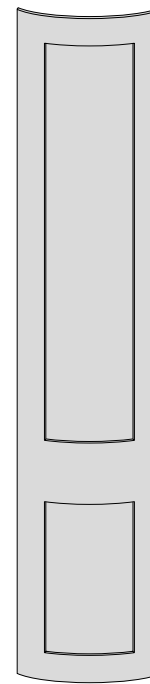

Parker Bedroom Curved Door

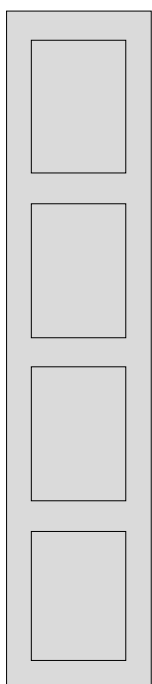

Parker Bedroom 4 Panel Door (5 Panel Door also available)

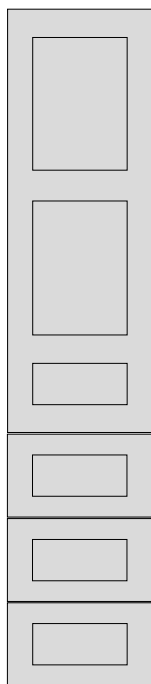

Parker Bedroom 3 Panel Stable Door

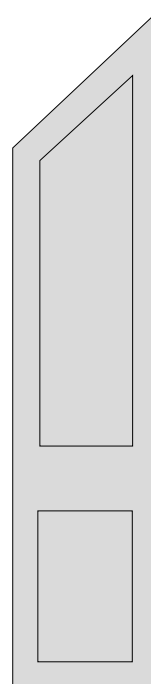

Parker Bedroom Angled Door

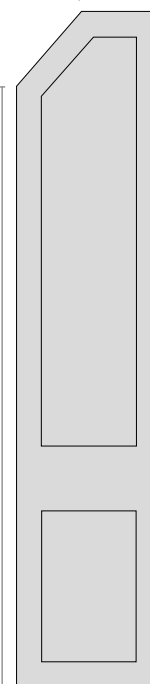

Parker Bedroom Angled Flat Top Door

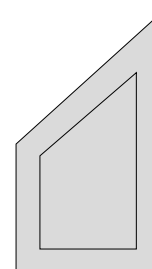

Parker Kitchen Angled Door

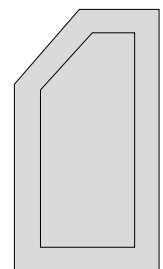

Parker Kitchen Angled Flat Top Door

Parker Door Cross Section

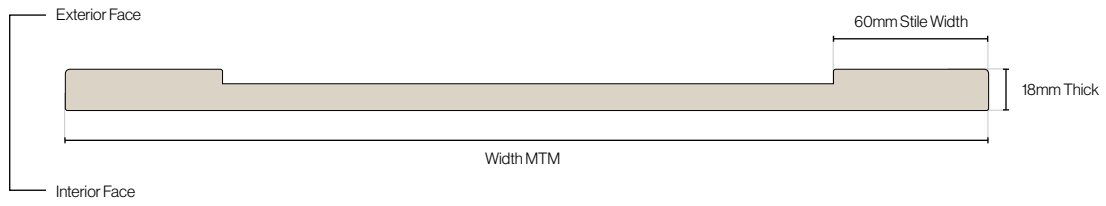

Parker Stile Cross Section

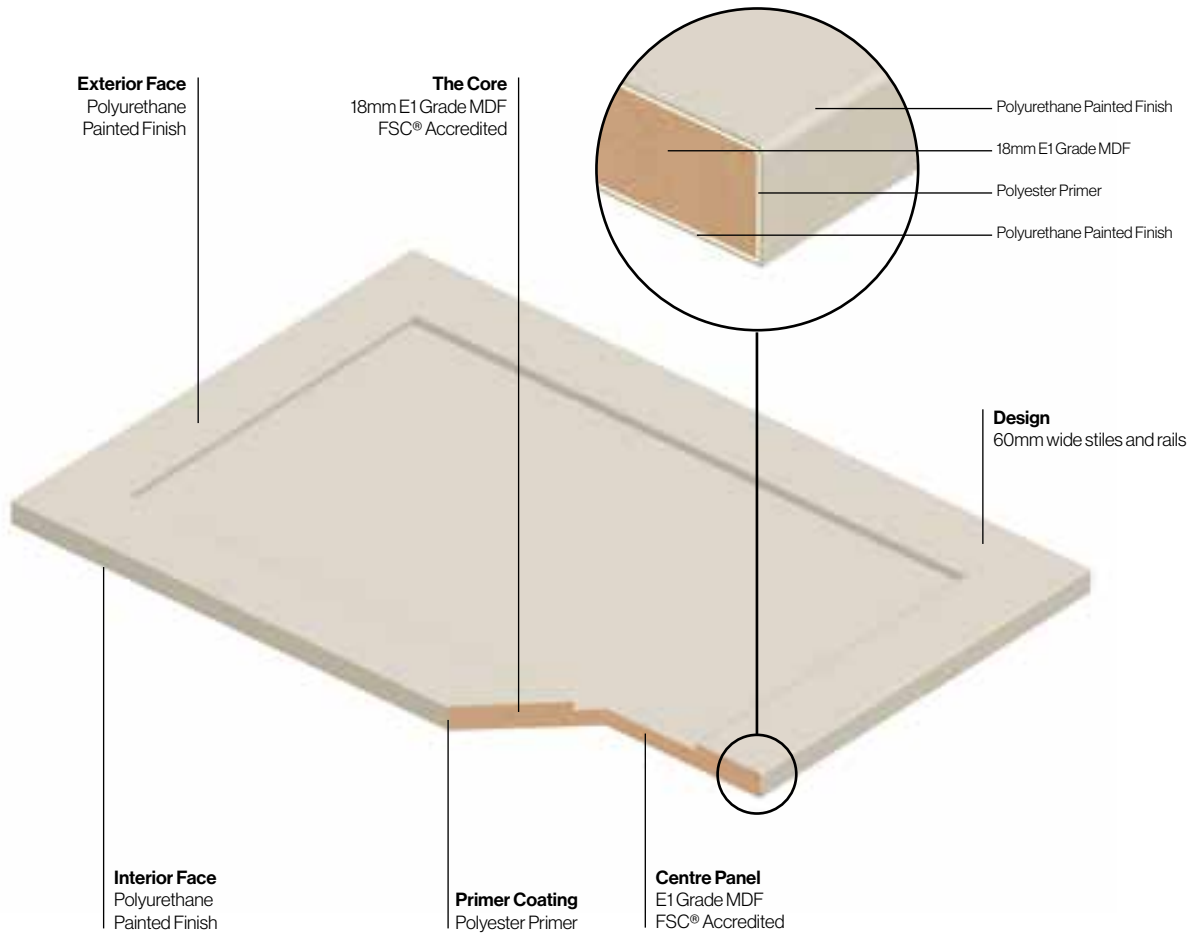
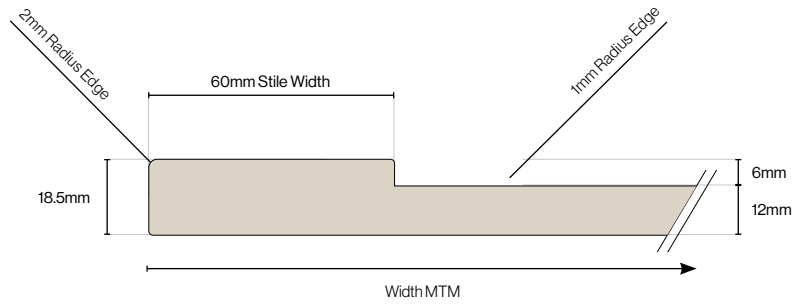

Hartford | MDF Matt Painted Door (Smooth)

MDF Painted | Ex.Stock and MTM



Door Specification

Description	Plain Shaker Style Door with 90mm Stiles and Rails
Finish	Smooth Matt Painted Finish
Door Thickness	18mm Thick
Base Material	MDF Core



4 Ex.Stock Colours



31 Painted Colours



Available Painted to Order standard sizes.



Available Made to Measure Unfinished Only*



Available Primed / Unfinished*

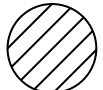

Smooth Surface



Hartford | Colours / Finishes

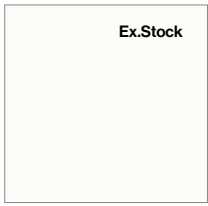

Primed

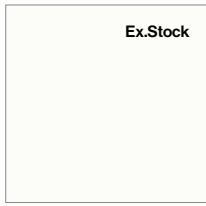

White

Colours swatches shown are approximate.

See Painted Swatch Book for true colour match.

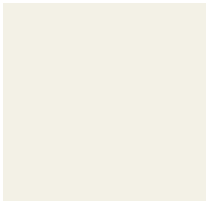

Porcelano



Highland Grey

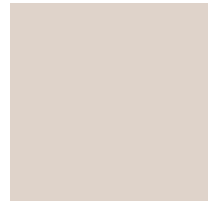

Cashmere



Sea Breeze



Light Blue

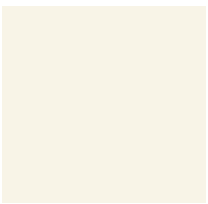

Ivory



Light Grey



French Chalk



Sage



Denim

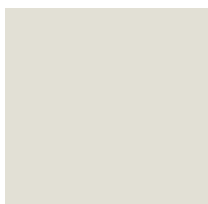

Mussel



Dust Grey



Heritage Pink



Liberty Green



Eiffel Blue



Dakar

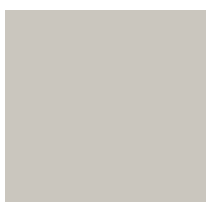

Pebble

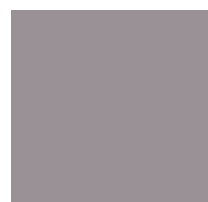

French Lavender



Moss Green



Nautical



Stone Grey

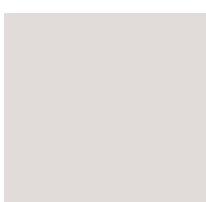

Taupe Grey

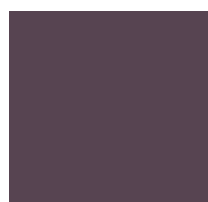

Foraged Fruit



Heritage Green



Marine Blue



Honeycomb

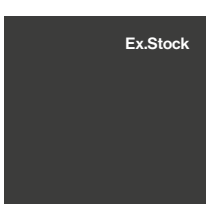

Graphite



Heritage Red



Conifer



Indigo

MDF Painted | Ex.Stock and MTM

Hartford | Door and Drawer Sizes

MDF Painted | Ex:Stock and MTM



Kitchen Door Sizes		
Doors Sizes	EXS PTO MTM	Curved Door sizes
115 x 596	570 x 446	715 x 300
140 x 296	570 x 496	
140 x 396	570 x 596	
140 x 446	645 x 596	
140 x 496	715 x 146	
140 x 596	715 x 246	
140 x 796	715 x 275	
140 x 896	715 x 296	
140 x 996	715 x 315	
175 x 396	715 x 346	
175 x 496	715 x 396	
175 x 596	715 x 446	
283 x 496	715 x 496	
283 x 596	715 x 546	
283 x 796	715 x 596	
283 x 896	895 x 296	
283 x 996	895 x 396	
355 x 496	895 x 446	
355 x 596	895 x 496	
355 x 760	895 x 596	
355 x 796	980 x 596	
355 x 896	1245 x 296	
355 x 996	1245 x 396	
450 x 596	1245 x 496	
495 x 396	1245 x 596	
495 x 596		
570 x 296		
570 x 396		
Plain Frame Sizes EXS PTO MTM		
		355 x 496 (Glazed)
		715 x 396 (Glazed)
		715 x 496 (Glazed)
		895 x 496 (Glazed)
		1060 x 496 (Glazed)

Bedroom Door Sizes		
Doors and Drawer Sizes	MTM	Curved Door Sizes
215 x 296	1495 x 596	1495 x 300
215 x 396	1595 x 296	1595 x 300
215 x 446	1595 x 396	2150 x 300
215 x 496	1595 x 446	2250 x 300
215 x 546	1595 x 496	
215 x 596	1595 x 596	
215 x 796	1735 x 296	
215 x 896	1735 x 396	
215 x 996	1735 x 446	
415 x 296	1735 x 496	
415 x 396	1735 x 596	
415 x 446	2150 x 296	
415 x 496	2150 x 396	
415 x 596	2150 x 446	
535 x 296	2150 x 496	
535 x 396	2150 x 596	
535 x 446	2250 x 296	
535 x 496	2250 x 396	
535 x 596	2250 x 446	
650 x 296	2250 x 496	
650 x 396	2250 x 596	
650 x 446	2400 x 296	
650 x 496	2400 x 396	
650 x 596	2400 x 446	
1495 x 296	2400 x 496	
1495 x 396	2400 x 596	
1495 x 446		
1495 x 496		

Non-Standard Kitchen Door Sizes - Priced next door size up.

Angled Kitchen Door Sizes - Priced as door size plus 50%.

Primed MTM Sizes are not available.

***Unfinished MTM** - These doors will be supplied as raw MDF.

Curved Kitchen Doors available any height up to 2250mm

Non-Standard Curved Kitchen Door Sizes - Priced next door size up.

Standard Kitchen Frame Sizes - Supplied Glazed.

MTM Plain Kitchen Frames - Priced as door size plus 35% (Supplied Unglazed).

Drilling - Additional charge per hole.

Non-Standard Bedroom Door Sizes - Priced next door size up.

Angled Bedroom Door Sizes - Priced as door size plus 50%.

Primed MTM Sizes are not available.

***Unfinished MTM** - These doors will be supplied as raw MDF.

Curved Bedroom Doors available any height up to 2250mm

Non-Standard Curved Bedroom Door Sizes - Priced next door size up.

MTM Plain Bedroom Frames - Priced as door size plus 35% (Supplied Unglazed).

Drilling - Additional charge per hole.

Hartford | Handleless Rail System Door Sizes



Plain Panel
(18mm thick)

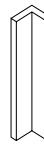

Internal Corner Post
685 x 70 x 70mm



External Corner Post
685 x 46 x 46mm



MDF Painted | Ex:Stock and MTM

Handleless Rail System Door Sizes

Kitchen Door Sizes		Bedroom Door Sizes		
160 x 296	490 x 296	1400 x 263	1500 x 413	2150 x 563
160 x 396	490 x 396	1400 x 281	1500 x 431	2150 x 581
160 x 446	490 x 446	1400 x 313	1500 x 463	2250 x 263
160 x 496	490 x 496	1400 x 331	1500 x 481	2250 x 281
160 x 596	490 x 596	1400 x 363	1500 x 513	2250 x 313
160 x 796	685 x 146	1400 x 381	1500 x 531	2250 x 331
160 x 896	685 x 296	1400 x 413	1500 x 563	2250 x 363
160 x 996	685 x 315	1400 x 431	1500 x 581	2250 x 381
325 x 496	685 x 346	1400 x 463	2150 x 263	2250 x 413
325 x 596	685 x 396	1400 x 481	2150 x 281	2250 x 431
325 x 796	685 x 446	1400 x 513	2150 x 313	2250 x 463
325 x 896	685 x 496	1400 x 531	2150 x 331	2250 x 481
325 x 996	685 x 596	1400 x 563	2150 x 363	2250 x 513
		1400 x 581	2150 x 381	2250 x 531
		1500 x 263	2150 x 413	2250 x 563
		1500 x 281	2150 x 431	2250 x 581
		1500 x 313	2150 x 463	
		1500 x 331	2150 x 481	
		1500 x 363	2150 x 513	
		1500 x 381	2150 x 531	

Drilling - Additional charge per hole.

Save time & money with **automatic pricing** through our online ordering service.



Order online at weborders.osdoors.com

Important: Always ensure doors are shielded from heat sources through the use of heat deflectors.

See page 226 for full range of heat deflector sizes.



Hartford | Door Specifications

MDF Painted | Ex:Stock and MTM

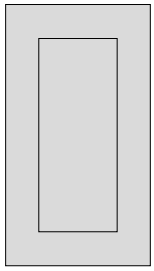

Hartford Kitchen Door

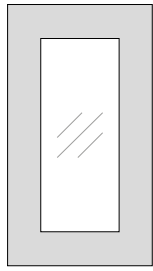

Hartford Kitchen Frame (Glazed)

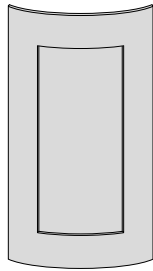

Hartford Kitchen Curved Door



Hartford Drawer

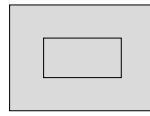

Hartford Pan Drawer

Hartford Kitchen Doors:

Kitchen Door sizes between 250mm - 1734mm high are supplied single panel as standard. Minimum Kitchen Door width is 246mm.

Hartford Drawers:

Drawer sizes between 100mm - 282mm high are supplied as flat panels as standard. Minimum Drawer width is 246mm.

Pan Drawer sizes between 250mm - 282mm high are supplied as single panels as standard. Minimum Pan Drawer width is 246mm.

Please note it's important to specify either Door, Drawer or Pan Drawer when ordering to ensure your order is processed correctly.

Hartford Frames:

Full Open Frames between 250mm - 1734mm high are supplied as single panel as standard.

Top Open Frames between 1735mm - 2400mm high are supplied with a double mid-rail which position is variable for each order (please specify required dimensions of split dimensions). The mid rail is measured from the base of the door to the centre of the mid rail unless otherwise specified.

It's important to specify either Full Open Frame or Top Open Frame when ordering to ensure your order is processed correctly.

Standard Kitchen Frame sizes are supplied glazed. Non standard Kitchen and Bedroom Frame sizes are supplied unglazed. Unglazed frames are rebated on the reverse side and supplied with a glazing gasket.

Angled Frames are not available.

Hartford Curved Doors:

Curved doors are made to suit 300mm x 300mm cabinets only. Height availability ranges from 570mm up to 2250mm. Curved Door sizes between 1735mm - 2250mm high are supplied as 2 panel with a double mid-rail which position is variable for each order (please specify required dimensions of split dimensions). The mid rail is measured from the base of the door to the centre of the mid rail unless otherwise specified. Minimum Curved Door width is 246mm.

Concave doors are not available.

Hartford Bedroom Doors:

Bedroom Door sizes between 1735mm - 2400mm high are supplied as 2 panel with a double mid-rail which position is variable for each order (please specify required dimensions of split dimensions). The mid-rail is measured from the base of the door to the centre of the mid-rail unless otherwise specified.

If you require a 4 or 5 panel door this must be clearly stated when ordering. Both 4 and 5 panel doors will be supplied with single mid rails as standard.

Minimum Bedroom Door width is 246mm.

Drilling:

All door styles are supplied un-drilled unless requested by the customer. If drilling is required, drilling instructions must clearly state full dimensions for all holes required.

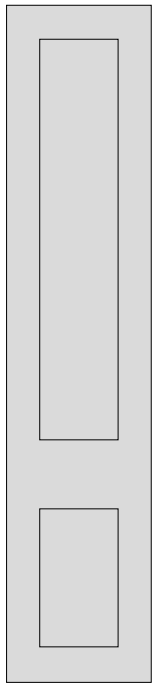

Hartford Bedroom Door

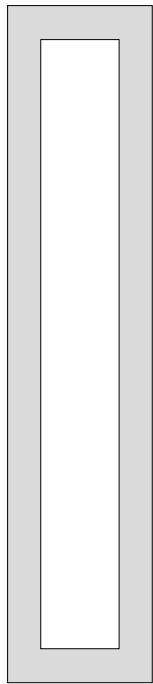

Hartford Bedroom Full Open Frame (Unglazed)

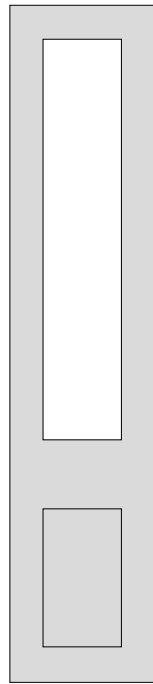

Hartford Bedroom Top Open Frame (Unglazed)

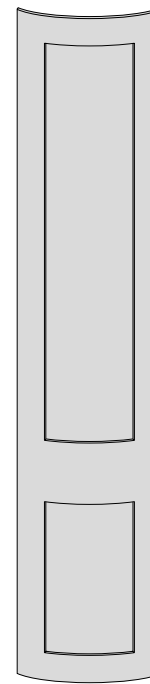

Hartford Bedroom Curved Door

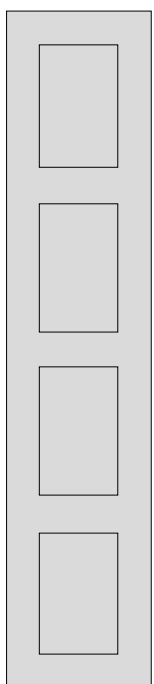

Hartford Bedroom 4 Panel Door (5 Panel Door also available)

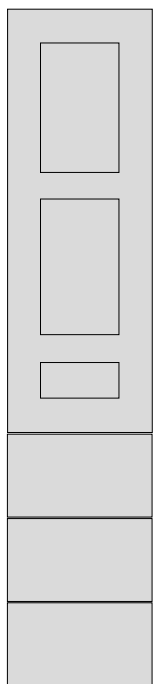

Hartford Bedroom 3 Panel Stable Door

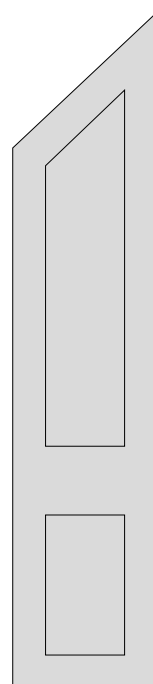

Hartford Bedroom Angled Door

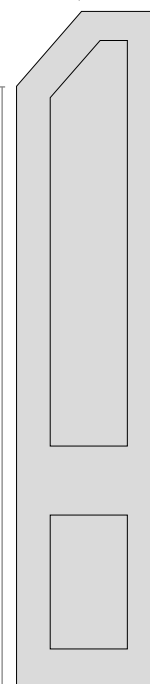

Hartford Bedroom Angled Flat Top Door

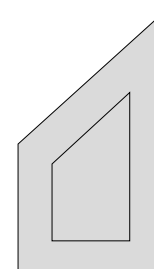

Hartford Kitchen Angled Door

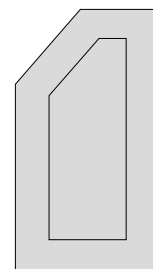

Hartford Kitchen Angled Flat Top Door

Hartford Door Cross Section

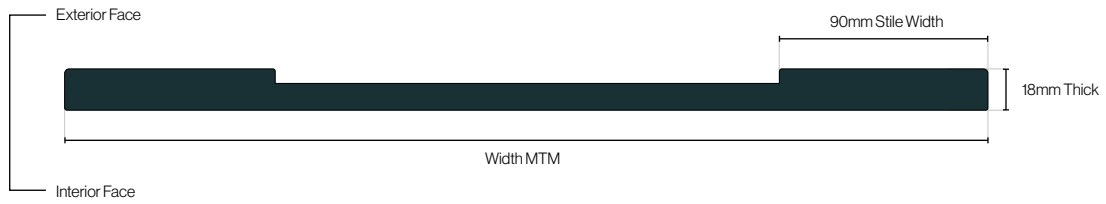

Hartford Stile Cross Section

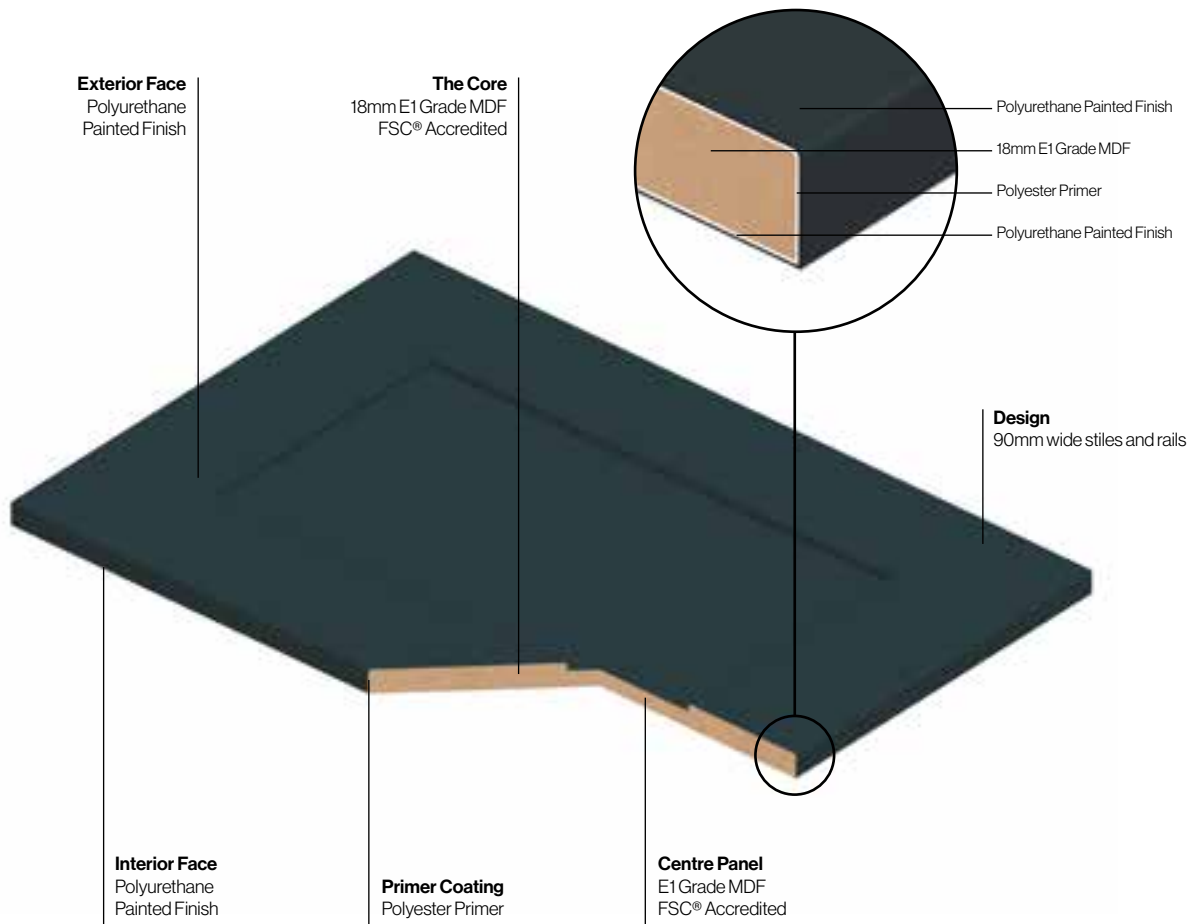
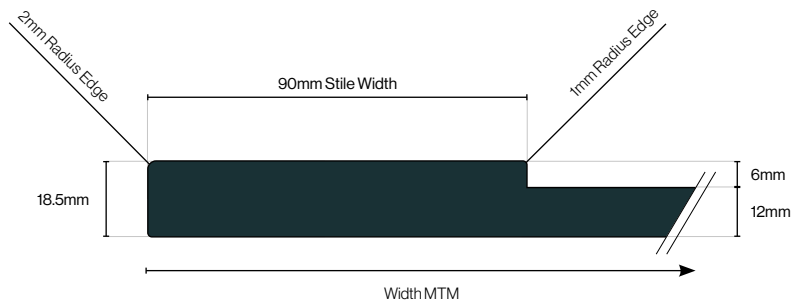

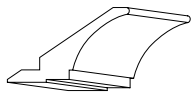

Classic Cornice
102mm (W) x 70mm (H)
3050mm Lengths

EXS PTO

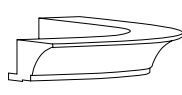

Curved Classic Cornice
419mm (L) x 419mm (W)
x 70mm (H)

EXS PTO

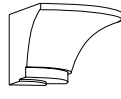

Classic Cornice Quadrant
98mm (L) x 98mm (W)
x 70mm (H)

EXS PTO

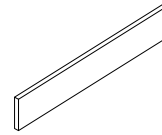

Plain Plinth
18mm (W) x 150mm (H)
3050mm Lengths

EXS PTO

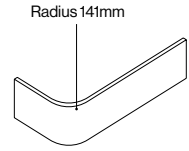

Curved Plain Plinth
540mm (L) x 232mm (W)
x 150mm (H)

EXS PTO

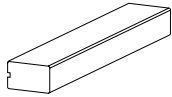

Modern Cornice / Pelmet
50mm (W) x 30mm (H)
3050mm Lengths

EXS PTO

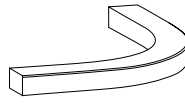

Curved Modern Cornice / Pelmet
350mm (L) x 350mm (W)
x 30mm (H)

EXS PTO

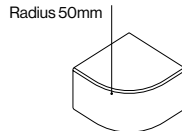

Modern Cornice / Pelmet Quadrant
50mm (L) x 50mm (W) x 30mm (H)

EXS PTO

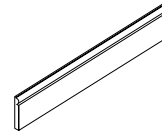

Torus Plinth
18mm (W) x 150mm (H)
3050mm Lengths

EXS PTO



Curved Torus Plinth
300mm (L) x 300mm (W)
x 150mm (H)

EXS PTO

Available Primed Ex.Stock Only.

Available Primed Ex.Stock Only.

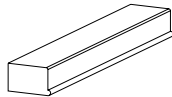

Under Cornice
50mm (W) x 30mm (H)
3050mm Lengths

EXS PTO

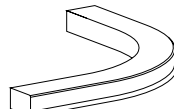

Curved Under Cornice
350mm (L) x 350mm (W)
x 30mm (H)

EXS PTO

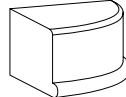

Under Cornice Quadrant
53mm (L) x 53mm (W)
x 30mm (H)

EXS PTO



Corner Post
30mm (L) x 30mm (W)
x 720mm (H)

EXS PTO

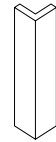

MTM Corner Post
715mm (150 x 150mm Max)

MTM PTO



Radius Profile (R 48mm)
70mm (W) x 50mm (H)
3050mm Lengths

EXS PTO

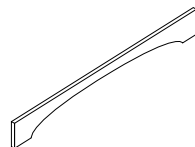

Arched Pelmet
2400mm (L) x 18mm (W)
x 200mm (H)

MTM PTO

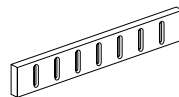

Fluted Rail
18mm (W) x 60mm (H)
2500mm Lengths

EXS PTO

Available Primed Ex.Stock Only.

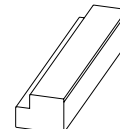

Square Base Pilaster
70mm (W) x 50mm (H)
3050mm Lengths

EXS PTO

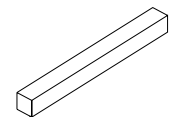

Square Base Pilaster Insert
965mm (L) x 18mm (W)
x 18mm (H)

EXS PTO



Plain Pilaster
100mm (W) x 900mm (H)
MTM up to 2500mm

MTM



Fluted Pilaster
100mm (W) x 900mm (H)
MTM up to 2500mm

MTM



Special Pilaster
100mm (W) x 900mm (H)
MTM up to 2500mm

MTM

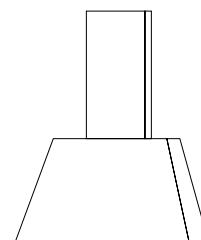

Chimney Canopy
900mm (W) x 400mm (D) x 1130mm (H)

EXS PTO

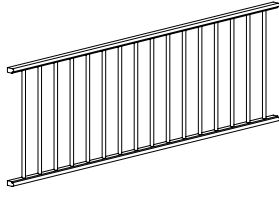
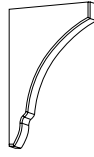

Plate Cot (Pair) /
1000mm (L) x 23mm (W) x 308mm (H)

EXS PTO



Shelf Bracket
100mm (L) x 18mm (W)
x 150mm (H)

EXS PTO

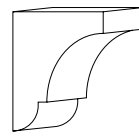

Corbel
125mm (L) x 90mm (W)
x 165mm (H)

EXS PTO

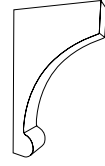

French Mantle Corbel
350mm (L) x 90mm (W)
x 600mm (H)

EXS PTO

Available Primed Ex:Stock Only.

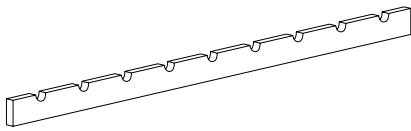

Wine Rack Rail
1200mm (L) x 18mm (W) x 60mm (H)

EXS PTO

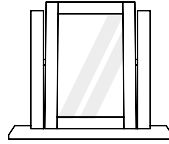

Single Square Mirror
485mm (W) x 570mm (H)

EXS PTO

Available Primed Ex:Stock Only.

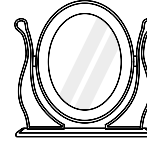

Single Oval Mirror
485mm (W) x 570mm (H)

EXS PTO

Available Primed Ex:Stock Only.



Touch Up Paint
Available 30ml or 1 Litre volumes.

Panel	Size MM	Primed Ex:Stock	Painted To Order	Unfinished MTM*	Painted MTM
Plain Panel	18mm / 785 x 360mm	●	●	×	×
Plain Panel	18mm / 900 x 360mm	●	●	×	×
Plain Panel	18mm / 900x 650mm	●	●	×	×
Plain Panel	18mm / 900 x 864mm	●	●	×	×
Plain Panel	18mm / 900 x 1160mm	●	●	×	×
Plain Panel	18mm / 900 x 1200mm	●	●	×	×
Plain Panel	18mm / 965 x 360mm	●	●	×	×
Plain Panel	18mm / 2400 x 360mm	●	●	×	×
Plain Panel	18mm / 2400x 650mm	●	●	×	×
Plain Panel	18mm / 2400x 900mm	●	●	×	×
Plain Panel	Made to Measure per m2	×	×	●	●
T&G Panel	Made to Measure per m2	×	×	●	●

*Unfinished MTM - These items will be supplied as unfinished MDF.



Plain Panel / 18mm Thick

EXS PTO MTM

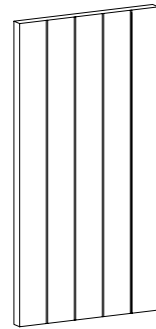

T&G Panel / 18mm Thick

MTM

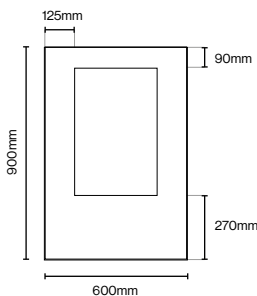

Single Feature Panel
900mm (H) x 600mm (W)

EXS PTO

Not available Primed. Standard Sizes Only.

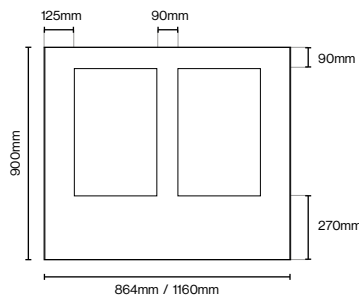

Double Feature Panel
900mm (H) x 864mm (W) /
900mm (H) x 1160mm (W)

EXS PTO

Not available Primed. Standard Sizes Only.

Headboards

MTM per m2. Hartford Headboards are supplied as single panels as standard unless otherwise specified.

Height Range: 500mm - 900mm
Width Range: 915mm - 1830mm

MTM

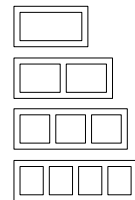

Standard Size MM:	Panel Availability:
3ft Headboard / 915mm	Single Panel
4ft Headboard / 1208mm	Single & 2 Panel
4.6ft Headboard / 1371mm	Single, 2 & 3 Panel
5ft Headboard / 1510mm	Single, 2, 3 & 4 Panel
6ft Headboard / 1830mm	Single, 2, 3 & 4 Panel

Wellington | MDF Matt Painted Door (Smooth)

MDF Painted | Ex.Stock and MTM



Door Specification

Description	Mock In-Frame Style Door with 90mm Stiles and Rails
Finish	Smooth Matt Painted Finish
Door Thickness	18mm Thick
Base Material	MDF Core



31 Painted Colours



Available Made to Order



Available Painted to Order standard sizes.



Available Made to Measure Unfinished Only*



Available Primed / Unfinished*

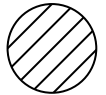

Smooth Surface



Wellington | Colours / Finishes

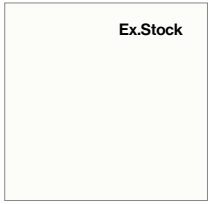

Primed



White

Colours swatches shown are approximate.

See Painted Swatch Book for true colour match.

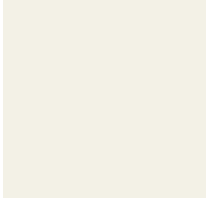

Porcelano

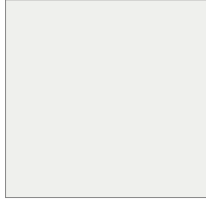

Highland Grey

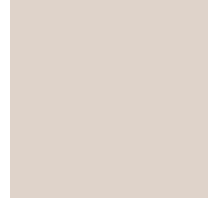

Cashmere



Sea Breeze

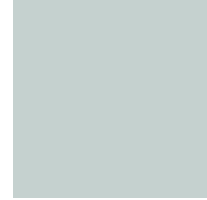

Light Blue

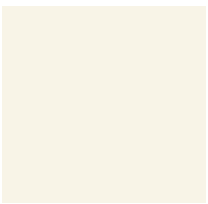

Ivory

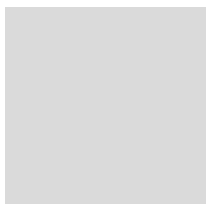

Light Grey



French Chalk



Sage



Denim

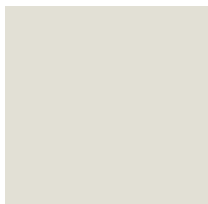

Mussel

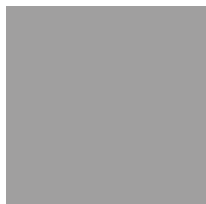

Dust Grey



Heritage Pink



Liberty Green



Eiffel Blue



Dakar

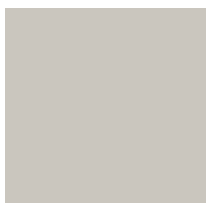

Pebble

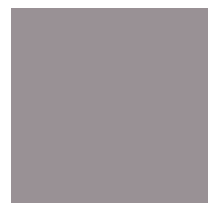

French Lavender



Moss Green



Nautical

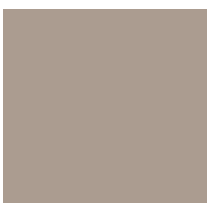

Stone Grey

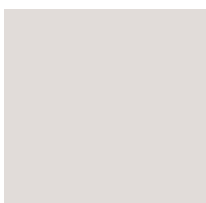

Taupe Grey

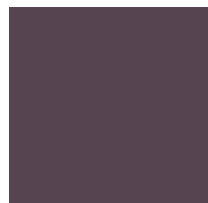

Foraged Fruit



Heritage Green



Marine Blue



Honeycomb

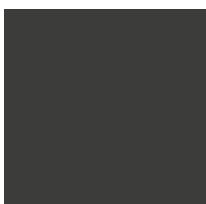

Graphite



Heritage Red

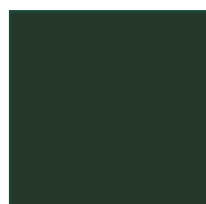

Conifer



Indigo

MDF Painted | Ex.Stock and MTM

Wellington | Door and Drawer Sizes

MDF Painted | Ex:Stock and MTM



Kitchen Door Sizes		
Doors Sizes	EXS PTO MTM	Curved Door sizes
115 x 596	570 x 446	715 x 300
140 x 296	570 x 496	
140 x 396	570 x 596	
140 x 446	645 x 596	
140 x 496	715 x 146	
140 x 596	715 x 246	
140 x 796	715 x 275	
140 x 896	715 x 296	
140 x 996	715 x 315	
175 x 396	715 x 346	
175 x 496	715 x 396	
175 x 596	715 x 446	
283 x 496	715 x 496	
283 x 596	715 x 546	
283 x 796	715 x 596	
283 x 896	895 x 296	
283 x 996	895 x 396	
355 x 496	895 x 446	
355 x 596	895 x 496	
355 x 760	895 x 596	
355 x 796	980 x 596	
355 x 896	1245 x 296	
355 x 996	1245 x 396	
450 x 596	1245 x 496	
495 x 396	1245 x 596	
495 x 596		
570 x 296		
570 x 396		
Plain Frame Sizes		
	EXS PTO MTM	
		355 x 496 (Glazed)
		715 x 396 (Glazed)
		715 x 496 (Glazed)
		895 x 496 (Glazed)
		1060 x 496 (Glazed)

Bedroom Door Sizes		
Doors and Drawer Sizes	MTM	Curved Door Sizes
215 x 296	1495 x 596	1495 x 300
215 x 396	1595 x 296	1595 x 300
215 x 446	1595 x 396	2150 x 300
215 x 496	1595 x 446	2250 x 300
215 x 546	1595 x 496	
215 x 596	1595 x 596	
215 x 796	1735 x 296	
215 x 896	1735 x 396	
215 x 996	1735 x 446	
415 x 296	1735 x 496	
415 x 396	1735 x 596	
415 x 446	2150 x 296	
415 x 496	2150 x 396	
415 x 596	2150 x 446	
535 x 296	2150 x 496	
535 x 396	2150 x 596	
535 x 446	2250 x 296	
535 x 496	2250 x 396	
535 x 596	2250 x 446	
650 x 296	2250 x 496	
650 x 396	2250 x 596	
650 x 446	2400 x 296	
650 x 496	2400 x 396	
650 x 596	2400 x 446	
1495 x 296	2400 x 496	
1495 x 396	2400 x 596	
1495 x 446		
1495 x 496		

Non-Standard Kitchen Door Sizes - Priced next door size up.

Angled Kitchen Door Sizes - Priced as door size plus 50%.

Primed MTM Sizes are not available.

***Unfinished MTM** - These doors will be supplied as raw MDF.

Curved Kitchen Doors available any height up to 2250mm

Non-Standard Curved Kitchen Door Sizes - Priced next door size up.

Standard Kitchen Frame Sizes - Supplied Glazed.

MTM Plain Kitchen Frames - Priced as door size plus 35% (Supplied Unglazed).

Drilling - Additional charge per hole.

Non-Standard Bedroom Door Sizes - Priced next door size up.

Angled Bedroom Door Sizes - Priced as door size plus 50%.

Primed MTM Sizes are not available.

***Unfinished MTM** - These doors will be supplied as raw MDF.

Curved Bedroom Doors available any height up to 2250mm

Non-Standard Curved Bedroom Door Sizes - Priced next door size up.

MTM Plain Bedroom Frames - Priced as door size plus 35% (Supplied Unglazed).

Drilling - Additional charge per hole.

Wellington | Handleless Rail System Door Sizes



Plain Panel
(18mm thick)



Internal Corner Post
685 x 70 x 70mm

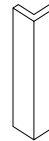

External Corner Post
685 x 46 x 46mm



MDF Painted | Ex:Stock and MTM

Handleless Rail System Door Sizes

Kitchen Door Sizes		Bedroom Door Sizes		
160 x 296	490 x 296	1400 x 263	1500 x 413	2150 x 563
160 x 396	490 x 396	1400 x 281	1500 x 431	2150 x 581
160 x 446	490 x 446	1400 x 313	1500 x 463	2250 x 263
160 x 496	490 x 496	1400 x 331	1500 x 481	2250 x 281
160 x 596	490 x 596	1400 x 363	1500 x 513	2250 x 313
160 x 796	685 x 146	1400 x 381	1500 x 531	2250 x 331
160 x 896	685 x 296	1400 x 413	1500 x 563	2250 x 363
160 x 996	685 x 315	1400 x 431	1500 x 581	2250 x 381
325 x 496	685 x 346	1400 x 463	2150 x 263	2250 x 413
325 x 596	685 x 396	1400 x 481	2150 x 281	2250 x 431
325 x 796	685 x 446	1400 x 513	2150 x 313	2250 x 463
325 x 896	685 x 496	1400 x 531	2150 x 331	2250 x 481
325 x 996	685 x 596	1400 x 563	2150 x 363	2250 x 513
		1400 x 581	2150 x 381	2250 x 531
		1500 x 263	2150 x 413	2250 x 563
		1500 x 281	2150 x 431	2250 x 581
		1500 x 313	2150 x 463	
		1500 x 331	2150 x 481	
		1500 x 363	2150 x 513	
		1500 x 381	2150 x 531	

Drilling - Additional charge per hole.

Save time & money with **automatic pricing** through our online ordering service.



Order online at weborders.osdoors.com

Important: Always ensure doors are shielded from heat sources through the use of heat deflectors.

See page 226 for full range of heat deflector sizes.



Wellington | Door Specifications

MDF Painted | Ex:Stock and MTM

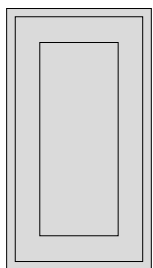

Wellington Kitchen Door

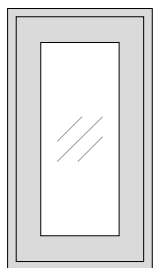

Wellington Kitchen Frame (Glazed)

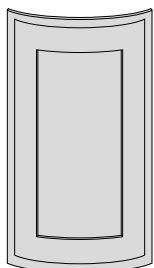

Wellington Kitchen Curved Door



Wellington Drawer

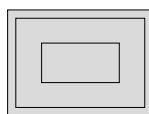

Wellington Pan Drawer

Wellington Kitchen Doors:

Kitchen Door sizes between 250mm - 1734mm high are supplied single panel as standard. Minimum Kitchen Door width is 246mm.

Wellington Drawers:

Drawer sizes between 100mm - 282mm high are supplied as flat panels as standard. Minimum Drawer width is 246mm.

Pan Drawer sizes between 250mm - 282mm high are supplied as single panels as standard. Minimum Pan Drawer width is 246mm.

Please note it's important to specify either Door, Drawer or Pan Drawer when ordering to ensure your order is processed correctly.

Wellington Frames:

Full Open Frames between 250mm - 1734mm high are supplied as single panel as standard.

Top Open Frames between 1735mm - 2400mm high are supplied with a double mid-rail which position is variable for each order (please specify required dimensions of split dimensions). The mid rail is measured from the base of the door to the centre of the mid rail unless otherwise specified.

It's important to specify either Full Open Frame or Top Open Frame when ordering to ensure your order is processed correctly.

Standard Kitchen Frame sizes are supplied glazed. Non standard Kitchen and Bedroom Frame sizes are supplied unglazed. Unglazed frames are rebated on the reverse side and supplied with a glazing gasket.

Angled Frames are not available.

Wellington Curved Doors:

Curved doors are made to suit 300mm x 300mm cabinets only. Height availability ranges from 570mm up to 2250mm. Curved Door sizes between 1735mm - 2250mm high are supplied as 2 panel with a double mid-rail which position is variable for each order (please specify required dimensions of split dimensions). The mid rail is measured from the base of the door to the centre of the mid rail unless otherwise specified. Minimum Curved Door width is 246mm.

Concave doors are not available.

Wellington Bedroom Doors:

Bedroom Door sizes between 1735mm - 2400mm high are supplied as 2 panel with a double mid-rail which position is variable for each order (please specify required dimensions of split dimensions). The mid-rail is measured from the base of the door to the centre of the mid-rail unless otherwise specified.

If you require a 4 or 5 panel door this must be clearly stated when ordering. Both 4 and 5 panel doors will be supplied with single mid rails as standard.

Minimum Bedroom Door width is 246mm.

Drilling:

All door styles are supplied un-drilled unless requested by the customer. If drilling is required, drilling instructions must clearly state full dimensions for all holes required.

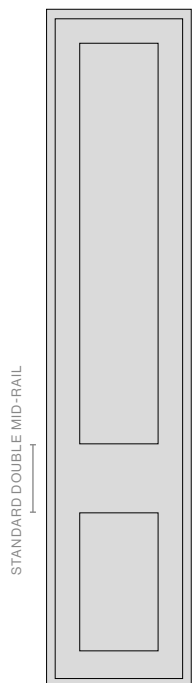

Wellington Bedroom Door

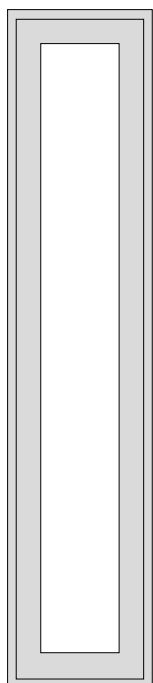

Wellington Bedroom Full Open Frame (Unglazed)

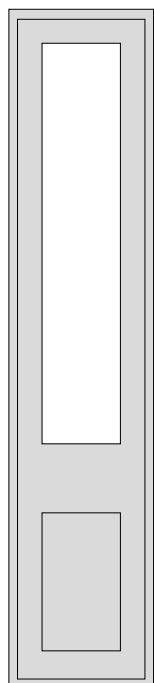

Wellington Bedroom Top Open Frame (Unglazed)

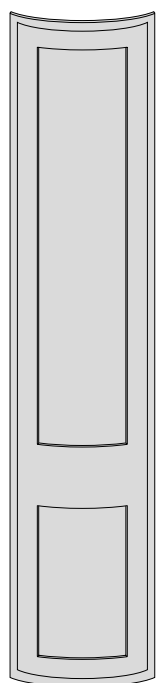

Wellington Bedroom Curved Door

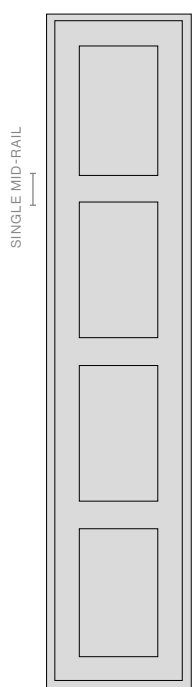

Wellington Bedroom 4 Panel Door (5 Panel Door also available)

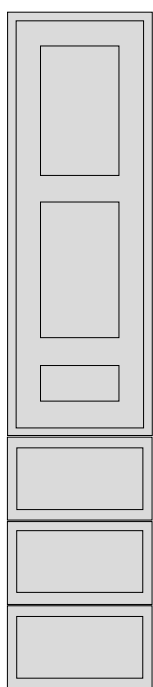

Wellington Bedroom 3 Panel Stable Door

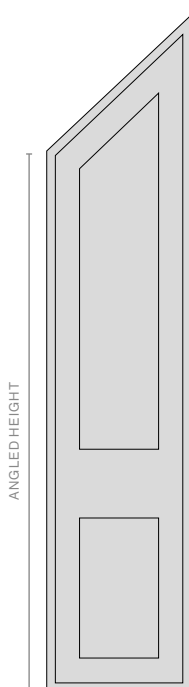

Wellington Bedroom Angled Door

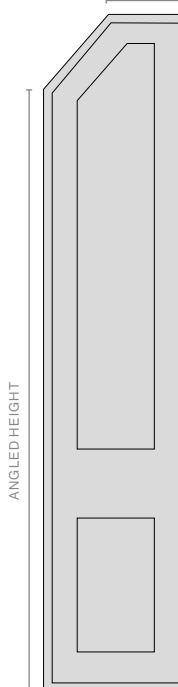

Wellington Bedroom Angled Flat Top Door

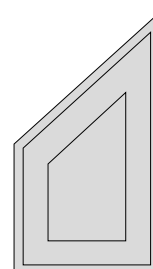

Wellington Kitchen Angled Door

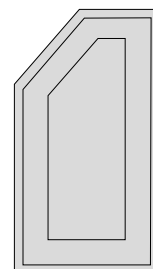

Wellington Kitchen Angled Flat Top Door

Wellington | Technical Specifications

Wellington Door Cross Section

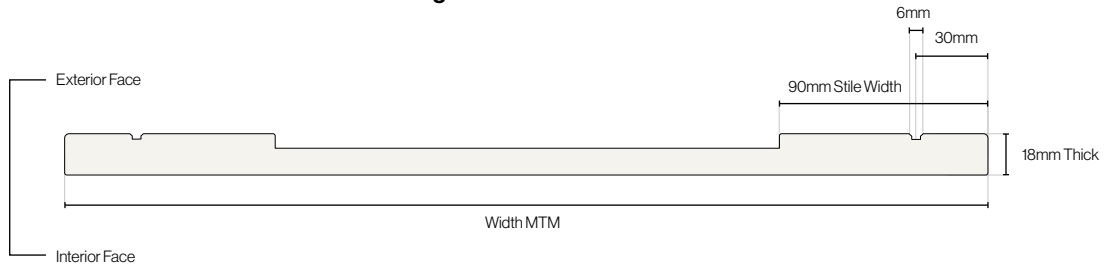

Wellington Stile Cross Section

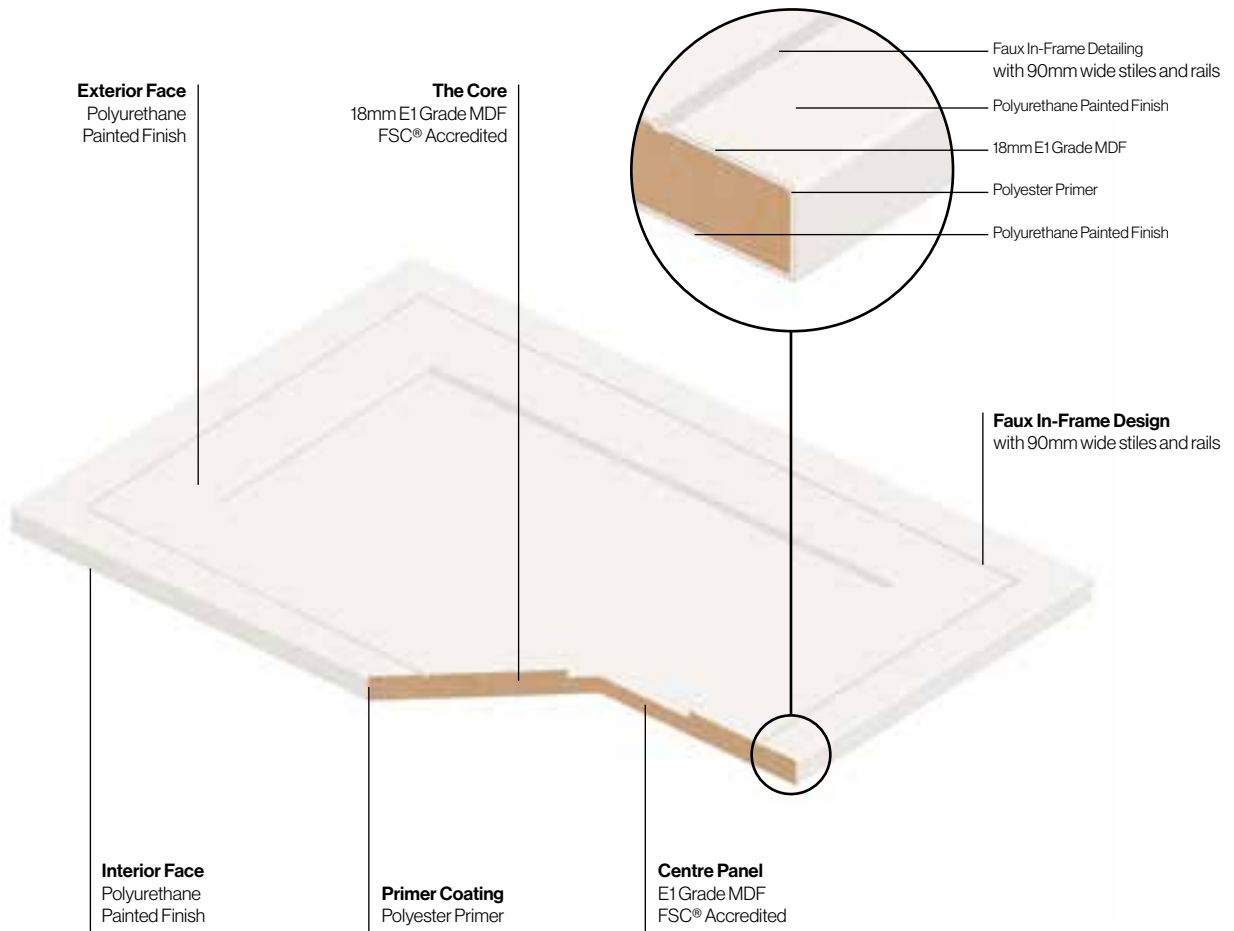
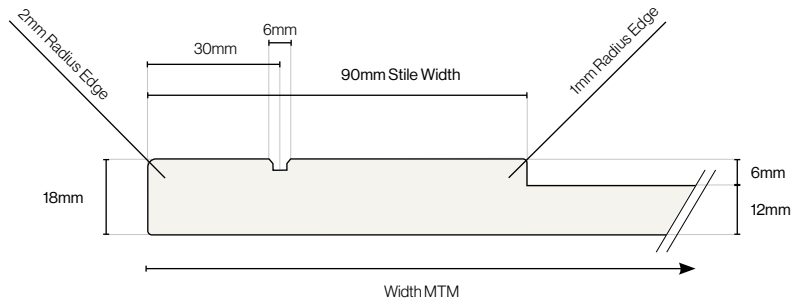

Wellington | Accessories

MDF Painted | Ex.Stock and MTM

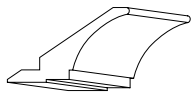

Classic Cornice
102mm (W) x 70mm (H)
3050mm Lengths

EXS PTO

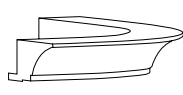

Curved Classic Cornice
419mm (L) x 419mm (W)
x 70mm (H)

EXS PTO

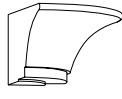

Classic Cornice Quadrant
98mm (L) x 98mm (W)
x 70mm (H)

EXS PTO

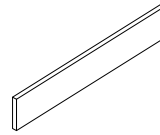

Plain Plinth
18mm (W) x 150mm (H)
3050mm Lengths

EXS PTO

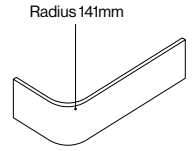

Curved Plain Plinth
540mm (L) x 232mm (W)
x 150mm (H)

EXS PTO

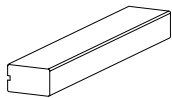

Modern Cornice / Pelmet
50mm (W) x 30mm (H)
3050mm Lengths

EXS PTO

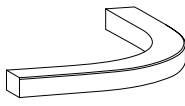

Curved Modern Cornice / Pelmet
350mm (L) x 350mm (W)
x 30mm (H)

EXS PTO

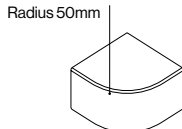

Modern Cornice / Pelmet Quadrant
50mm (L) x 50mm (W) x 30mm (H)

EXS PTO

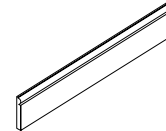

Torus Plinth
18mm (W) x 150mm (H)
3050mm Lengths

EXS PTO



Curved Torus Plinth
300mm (L) x 300mm (W)
x 150mm (H)

EXS PTO

Available Primed Ex.Stock Only.

Available Primed Ex.Stock Only.

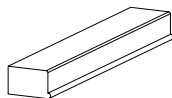

Under Cornice
50mm (W) x 30mm (H)
3050mm Lengths

EXS PTO

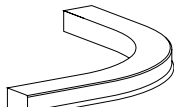

Curved Under Cornice
350mm (L) x 350mm (W)
x 30mm (H)

EXS PTO

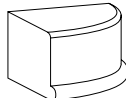

Under Cornice Quadrant
53mm (L) x 53mm (W)
x 30mm (H)

EXS PTO



Corner Post
30mm (L) x 30mm (W)
x 720mm (H)

EXS PTO

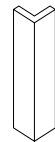

MTM Corner Post
715mm (150 x 150mm Max)

MTM PTO



Radius Profile (R 48mm)
70mm (W) x 50mm (H)
3050mm Lengths

EXS PTO

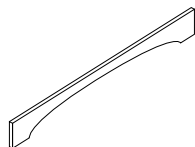

Arched Pelmet
2400mm (L) x 18mm (W)
x 200mm (H)

MTM PTO

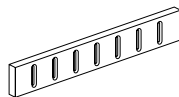

Fluted Rail
18mm (W) x 60mm (H)
2500mm Lengths

EXS PTO

Available Primed Ex.Stock Only.

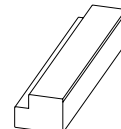

Square Base Pilaster
70mm (W) x 50mm (H)
3050mm Lengths

EXS PTO

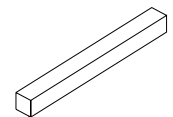

Square Base Pilaster Insert
965mm (L) x 18mm (W)
x 18mm (H)

EXS PTO



Plain Pilaster
100mm (W) x 900mm (H)
MTM up to 2500mm

MTM



Fluted Pilaster
100mm (W) x 900mm (H)
MTM up to 2500mm

MTM

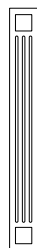

Special Pilaster
100mm (W) x 900mm (H)
MTM up to 2500mm

MTM

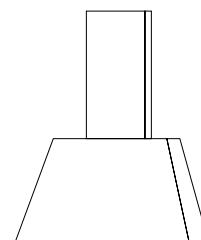

Chimney Canopy
900mm (W) x 400mm (D) x 1130mm (H)

EXS PTO

Wellington | Accessories

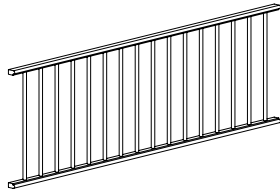
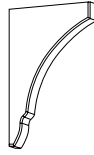

Plate Cot (Pair) /
1000mm (L) x 23mm (W) x 308mm (H)

EXS PTO



Shelf Bracket
100mm (L) x 18mm (W)
x 150mm (H)

EXS PTO

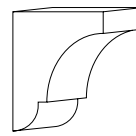

Corbel
125mm (L) x 90mm (W)
x 165mm (H)

EXS PTO

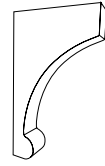

French Mantle Corbel
350mm (L) x 90mm (W)
x 600mm (H)

EXS PTO

Available Primed Ex.Stock Only.

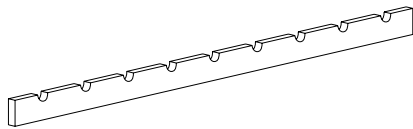

Wine Rack Rail
1200mm (L) x 18mm (W) x 60mm (H)

EXS PTO

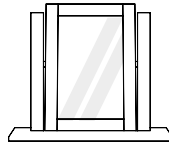

Single Square Mirror
485mm (W) x 570mm (H)

EXS PTO

Available Primed Ex.Stock Only.

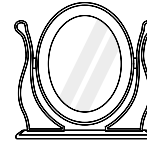

Single Oval Mirror
485mm (W) x 570mm (H)

EXS PTO

Available Primed Ex.Stock Only.



Touch Up Paint
Available 30ml or 1 Litre volumes.

Panel	Size MM	Primed Ex.Stock	Painted To Order	Unfinished MTM*	Painted MTM
Plain Panel	18mm / 785 x 360mm	●	●	×	×
Plain Panel	18mm / 900 x 360mm	●	●	×	×
Plain Panel	18mm / 900x 650mm	●	●	×	×
Plain Panel	18mm / 900 x 864mm	●	●	×	×
Plain Panel	18mm / 900 x 1160mm	●	●	×	×
Plain Panel	18mm / 900 x 1200mm	●	●	×	×
Plain Panel	18mm / 965 x 360mm	●	●	×	×
Plain Panel	18mm / 2400 x 360mm	●	●	×	×
Plain Panel	18mm / 2400x 650mm	●	●	×	×
Plain Panel	18mm / 2400x 900mm	●	●	×	×
Plain Panel	Made to Measure per m2	×	×	●	●
T&G Panel	Made to Measure per m2	×	×	●	●

*Unfinished MTM - These items will be supplied as unfinished MDF.

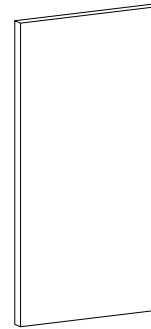

Plain Panel / 18mm Thick

EXS PTO MTM

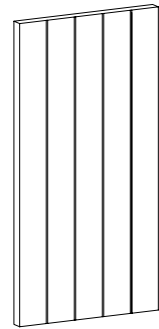

T&G Panel / 18mm Thick

MTM

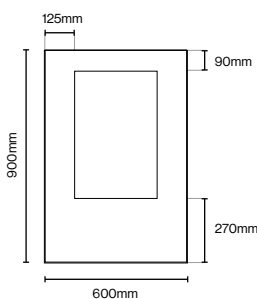

Single Feature Panel
900mm (H) x 600mm (W)

EXS PTO

Not available Primed. Standard Sizes Only.

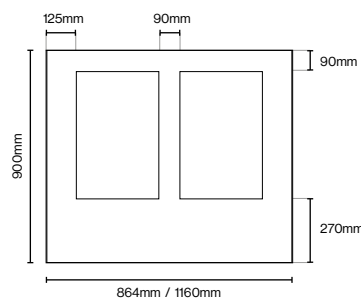

Double Feature Panel
900mm (H) x 864mm (W) /
900mm (H) x 1160mm (W)

EXS PTO

Not available Primed. Standard Sizes Only.

Headboards

MTM per m2. Hartford Headboards are supplied as single panels as standard unless otherwise specified.

Height Range: 500mm - 900mm
Width Range: 915mm - 1830mm

MTM

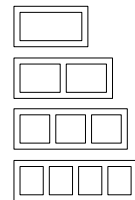

Standard Size MM:	Panel Availability:
3ft Headboard / 915mm	Single Panel
4ft Headboard / 1208mm	Single & 2 Panel
4.6ft Headboard / 1371mm	Single, 2 & 3 Panel
5ft Headboard / 1510mm	Single, 2, 3 & 4 Panel
6ft Headboard / 1830mm	Single, 2, 3 & 4 Panel

Belair | MDF Matt Painted Door (Smooth)

MDF Painted | Ex.Stock and MTM



Featured in Ethos Painted Brochure

Door Specification

Description	Plain Slab Style Door
Finish	Smooth Matt Painted Finish
Door Thickness	18mm Thick
Base Material	MDF Core
Edge	Paint-able 1mm ABS Edging



31 Painted Colours



Available Painted to Order standard sizes.



Available Made to Measure



Available Unfinished*



Smooth Surface



Belair | Kitchen Door Sizes



Primed



White

Colours swatches shown are approximate.

See Painted Swatch Book for true colour match.

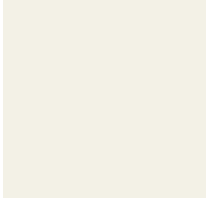

Porcelano

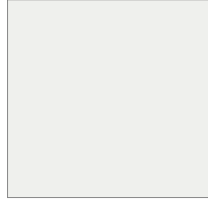

Highland Grey

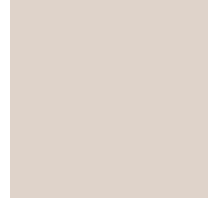

Cashmere



Sea Breeze

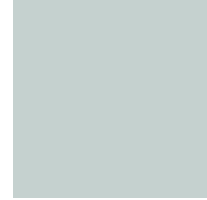

Light Blue

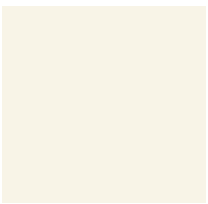

Ivory

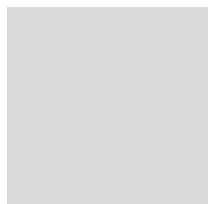

Light Grey



French Chalk



Sage



Denim

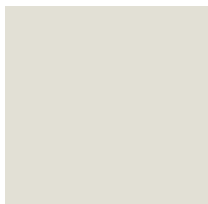

Mussel

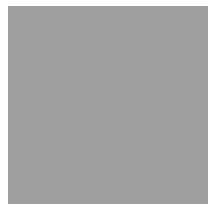

Dust Grey



Heritage Pink



Liberty Green



Eiffel Blue



Dakar

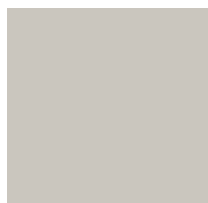

Pebble

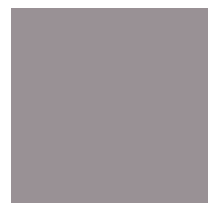

French Lavender



Moss Green



Nautical

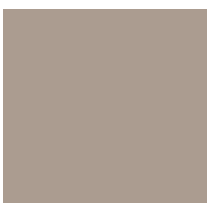

Stone Grey

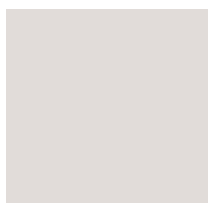

Taupe Grey

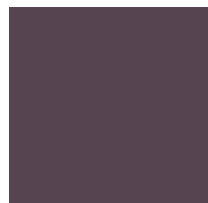

Foraged Fruit



Heritage Green



Marine Blue



Honeycomb

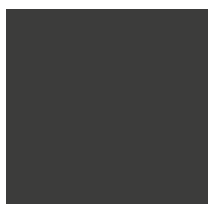

Graphite



Heritage Red

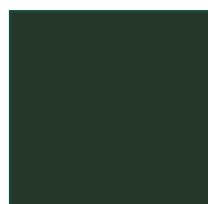

Conifer



Indigo

MDF Painted | Ex:Stock and MTM

Belair | Door and Drawer Sizes

MDF Painted | Ex:Stock and MTM



Kitchen Door Sizes				
Doors and Drawer Sizes		MTM	Curved Door sizes	MTM
115 x 596	570 x 446		715 x 300	
140 x 296	570 x 496		895 x 300	
140 x 396	570 x 596		1245 x 300	
140 x 446	645 x 596		1965 x 300	
140 x 496	715 x 146			
140 x 596	715 x 246			
140 x 796	715 x 275			
140 x 896	715 x 296			
140 x 996	715 x 315			
175 x 396	715 x 346			
175 x 496	715 x 396			
175 x 596	715 x 446			
283 x 496	715 x 496			
283 x 596	715 x 546			
283 x 796	715 x 596			
283 x 896	895 x 296			
283 x 996	895 x 396			
355 x 496	895 x 446			
355 x 596	895 x 496			
355 x 760	895 x 596			
355 x 796	980 x 596			
355 x 896	1060 x 396			
355 x 996	1060 x 496			
450 x 596	1060 x 596			
495 x 396	1245 x 296			
495 x 596	1245 x 396			
570 x 296	1245 x 496			
570 x 396	1245 x 596			

Bedroom Door Sizes				
Doors and Drawer Sizes		MTM	Curved Door Sizes	MTM
215 x 296	1495 x 596		1495 x 300	
215 x 396	1595 x 296		1595 x 300	
215 x 446	1595 x 396		2150 x 300	
215 x 496	1595 x 446		2250 x 300	
215 x 546	1595 x 496			
215 x 596	1595 x 596			
215 x 796	1735 x 296			
215 x 896	1735 x 396			
215 x 996	1735 x 446			
415 x 296	1735 x 496			
415 x 396	1735 x 596			
415 x 446	2150 x 296			
415 x 496	2150 x 396			
415 x 596	2150 x 446			
535 x 296	2150 x 496			
535 x 396	2150 x 596			
535 x 446	2250 x 296			
535 x 496	2250 x 396			
535 x 596	2250 x 446			
650 x 296	2250 x 496			
650 x 396	2250 x 596			
650 x 446	2400 x 296			
650 x 496	2400 x 396			
650 x 596	2400 x 446			
1495 x 296	2400 x 496			
1495 x 396	2400 x 596			
1495 x 446				
1495 x 496				

Non-Standard Kitchen Door Sizes - Priced next door size up.
Angled Kitchen Door Sizes - Priced as door size plus 50%.
Primed MTM Sizes are not available.
Unfinished MTM - These doors will be supplied as raw MDF.

Curved Kitchen Doors available any height up to 2250mm
Non-Standard Curved Kitchen Door Sizes - Priced next door size up.

MTM Plain Kitchen Frames - Priced as door size plus 35% (Supplied Unglazed).

Drilling - Additional charge per hole.

Non-Standard Bedroom Door Sizes - Priced next door size up.
Angled Bedroom Door Sizes - Priced as door size plus 50%.
Primed MTM Sizes are not available.
Unfinished MTM - These doors will be supplied as raw MDF.

Curved Bedroom Doors available any height up to 2250mm
Non-Standard Curved Bedroom Door Sizes - Priced next door size up.

MTM Plain Bedroom Frames - Priced as door size plus 35% (Supplied Unglazed).

Drilling - Additional charge per hole.

Belair | Handleless Rail System Door Sizes



Plain Panel
(18mm thick)



Internal Corner Post
685 x 70 x 70mm



External Corner Post
685 x 46 x 46mm



MDF Painted | Ex:Stock and MTM

Handleless Rail System Door Sizes

Kitchen Door Sizes		MTM	Bedroom Door Sizes			MTM
160 x 296	490 x 296		1400 x 263	1500 x 413	2150 x 563	
160 x 396	490 x 396		1400 x 281	1500 x 431	2150 x 581	
160 x 446	490 x 446		1400 x 313	1500 x 463	2250 x 263	
160 x 496	490 x 496		1400 x 331	1500 x 481	2250 x 281	
160 x 596	490 x 596		1400 x 363	1500 x 513	2250 x 313	
160 x 796	685 x 146		1400 x 381	1500 x 531	2250 x 331	
160 x 896	685 x 296		1400 x 413	1500 x 563	2250 x 363	
160 x 996	685 x 315		1400 x 431	1500 x 581	2250 x 381	
325 x 496	685 x 346		1400 x 463	2150 x 263	2250 x 413	
325 x 596	685 x 396		1400 x 481	2150 x 281	2250 x 431	
325 x 796	685 x 446		1400 x 513	2150 x 313	2250 x 463	
325 x 896	685 x 496		1400 x 531	2150 x 331	2250 x 481	
325 x 996	685 x 596		1400 x 563	2150 x 363	2250 x 513	
			1400 x 581	2150 x 381	2250 x 531	
			1500 x 263	2150 x 413	2250 x 563	
			1500 x 281	2150 x 431	2250 x 581	
			1500 x 313	2150 x 463		
			1500 x 331	2150 x 481		
			1500 x 363	2150 x 513		
			1500 x 381	2150 x 531		

Drilling - Additional charge per hole.

Save time & money with **automatic pricing** through our online ordering service.

Order online at weborders.osdoors.com

Important: Always ensure doors are shielded from heat sources through the use of heat deflectors.

See page 226 for full range of heat deflector sizes.

Belair | Door Specifications

MDF Painted | Ex:Stock and MTM

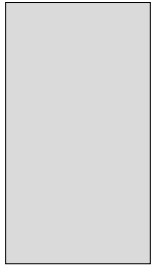

Belair Kitchen Door

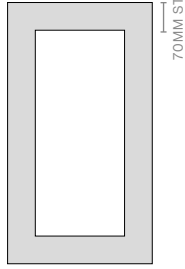

Belair Kitchen Frame (Unglazed) 70mm stile

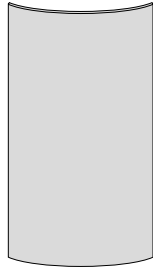

Belair Kitchen Curved Door



Belair Drawer



Belair Pan Drawer

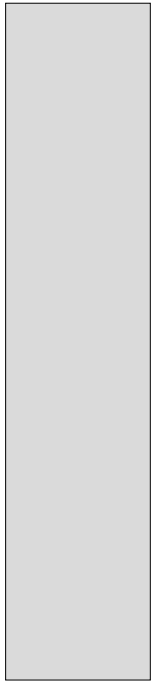

Belair Bedroom Door

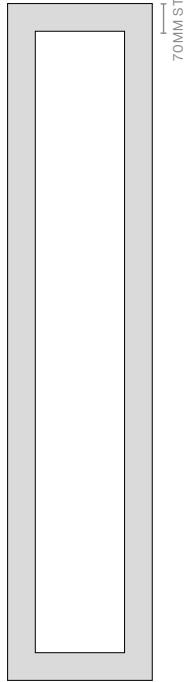

Belair Bedroom Full Open Frame

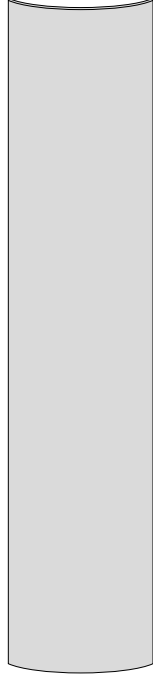

Belair Bedroom Curved Door

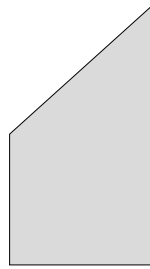

Belair Kitchen Angled Door

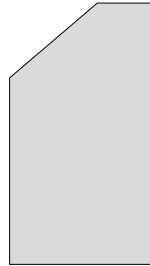

Belair Kitchen Angled Flat Top Door

Belair Kitchen Doors:

Door sizes between 250mm - 1734mm high are supplied flat panel as standard. Minimum Kitchen Door width is 246mm.

Belair Drawers:

Drawer sizes between 100mm - 282mm high are supplied flat panel as standard. Minimum Drawer width is 246mm.

Pan Drawer sizes between 250mm - 282mm high are supplied flat panel as standard. Minimum Pan Drawer width is 246mm.

Please note it's important to specify either Door, Drawer or Pan Drawer when ordering to ensure your order is processed correctly.

Belair Frames:

Frames between 250mm - 2400mm high are supplied flat panel Full Open Frames with a 70mm stile as standard.

Top Open Frames between 1735mm - 2400mm high are supplied with a double mid-rail which position is variable for each order (please specify required dimensions of split dimensions). The mid rail is measured from the base of the door to the centre of the mid rail unless otherwise specified.

If you require a Top Open Frame this must be clearly stated when ordering, and full details on sizes required must be included.

Belair Curved Doors:

Curved doors are made to suit 300mm x 300mm cabinets only. Height availability ranges from 570mm up to 2250mm.

Belair Bedroom Doors:

Bedroom Door sizes between 1735mm - 2400mm high are supplied flat panel as standard. Minimum Bedroom Door width is 246mm.

Drilling:

All door styles are supplied un-drilled unless requested by the customer. If drilling is required, drilling instructions must clearly state full dimensions for all holes required.

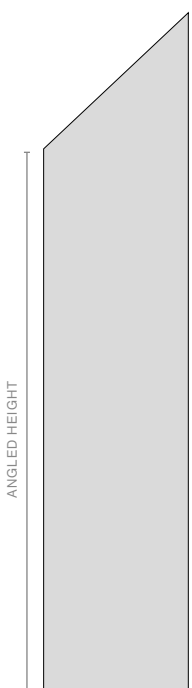

Belair Bedroom Angled Left Hand Door

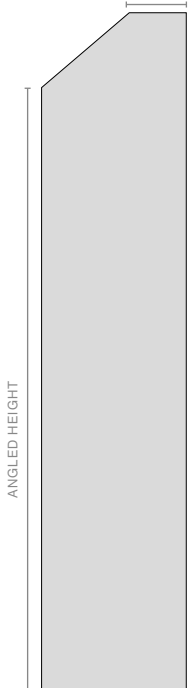

Belair Bedroom Angled Flat Top Left Hand Door

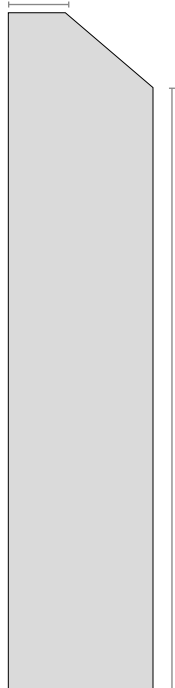

Belair Bedroom Angled Flat Top Right Hand Door

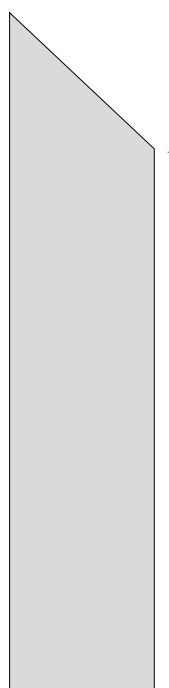

Belair Bedroom Angled Right Hand Door

Belair | Technical Specifications

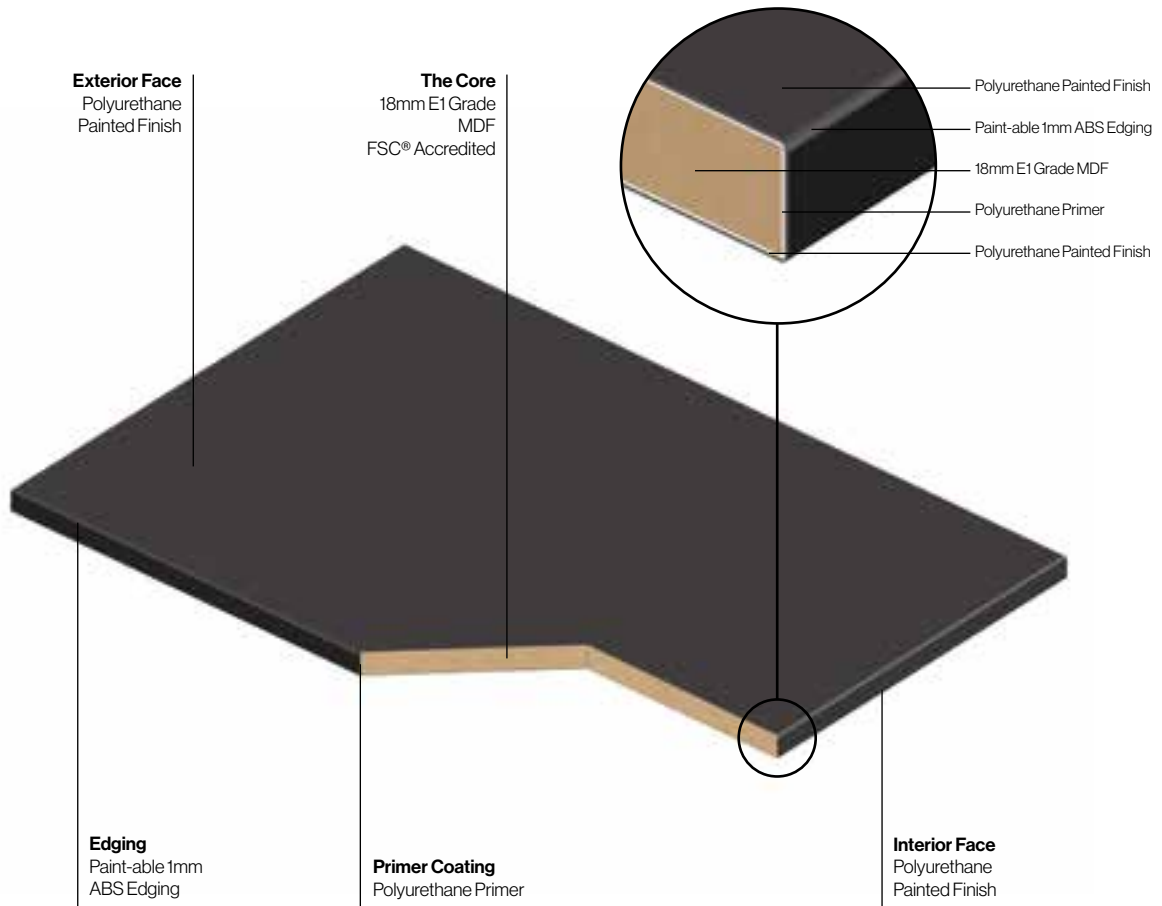

MDF Painted | Ex:Stock and MTM

Belair | Accessories

MDF Painted | Ex:Stock and MTM

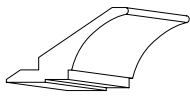

Classic Cornice
102mm (W) x 70mm (H)
3050mm Lengths

EXS PTO

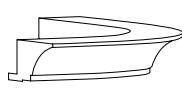

Curved Classic Cornice
419mm (L) x 419mm (W)
x 70mm (H)

EXS PTO

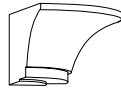

Classic Cornice Quadrant
98mm (L) x 98mm (W)
x 70mm (H)

EXS PTO

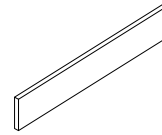

Plain Plinth
18mm (W) x 150mm (H)
3050mm Lengths

EXS PTO

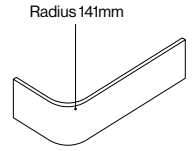

Curved Plain Plinth
540mm (L) x 232mm (W)
x 150mm (H)

EXS PTO

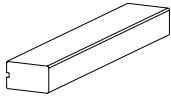

Modern Cornice / Pelmet
50mm (W) x 30mm (H)
3050mm Lengths

EXS PTO

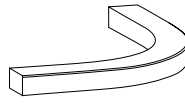

Curved Modern Cornice / Pelmet
350mm (L) x 350mm (W)
x 30mm (H)

EXS PTO

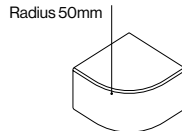

Modern Cornice / Pelmet Quadrant
50mm (L) x 50mm (W) x 30mm (H)

EXS PTO

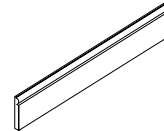

Torus Plinth
18mm (W) x 150mm (H)
3050mm Lengths

EXS PTO



Curved Torus Plinth
300mm (L) x 300mm (W)
x 150mm (H)

EXS PTO

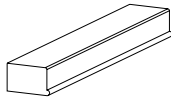

Under Cornice
50mm (W) x 30mm (H)
3050mm Lengths

EXS PTO

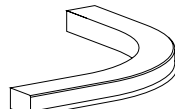

Curved Under Cornice
350mm (L) x 350mm (W)
x 30mm (H)

EXS PTO

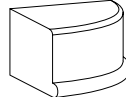

Under Cornice Quadrant
53mm (L) x 53mm (W)
x 30mm (H)

EXS PTO

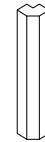

Corner Post
30mm (L) x 30mm (W)
x 720mm (H)

EXS PTO

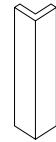

MTM Corner Post
715mm (150 x 150mm Max)

MTM

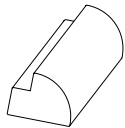

Radius Profile (R 48mm)
70mm (W) x 50mm (H)
3050mm Lengths

EXS PTO

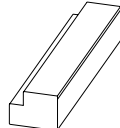

Square Base Pilaster
70mm (W) x 50mm (H)
3050mm Lengths

EXS PTO

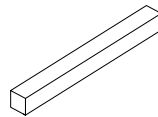

Square Base Pilaster Insert
965mm (L) x 18mm (W)
x 18mm (H)

EXS PTO

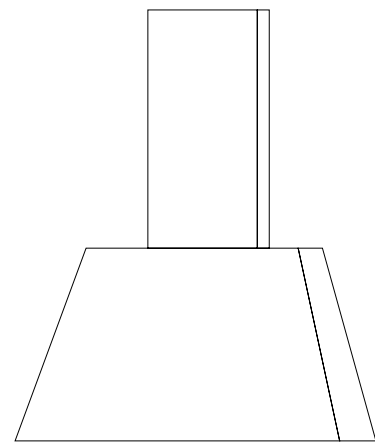

Chimney Canopy
900mm (W) x 400mm (D) x 1130mm (H)

PTO

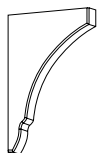

Shelf Bracket
100mm (L) x 18mm (W)
x 150mm (H)

EXS PTO

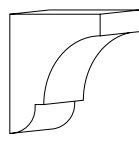

Corbel
125mm (L) x 90mm (W)
x 165mm (H)

EXS PTO

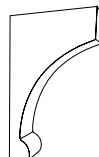

French Mantle Corbel
350mm (L) x 90mm (W)
x 600mm (H)

EXS PTO

Belair | Accessories

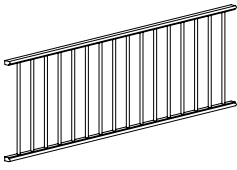
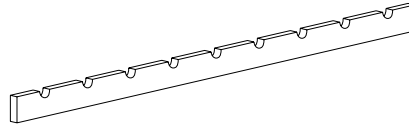

Plate Cot (Pair) /
1000mm (L) x 23mm (W) x 308mm (H)

EXS PTO



Wine Rack Rail
1200mm (L) x 18mm (W) x 60mm (H)

EXS PTO

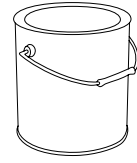

Touch Up Paint
Available 30ml or 1 Litre volumes.

Panel	Size MM	Primed Ex:Stock	Painted To Order	Unfinished MTM*	Painted MTM
Plain Panel	18mm / 785 x 360mm	●	●	×	●
Plain Panel	18mm / 900 x 360mm	●	●	×	●
Plain Panel	18mm / 900x 650mm	●	●	×	●
Plain Panel	18mm / 900 x 864mm	●	●	×	●
Plain Panel	18mm / 900 x 1160mm	●	●	×	●
Plain Panel	18mm / 900 x 1200mm	●	●	×	●
Plain Panel	18mm / 965 x 360mm	●	●	×	●
Plain Panel	18mm / 2400 x 360mm	●	●	×	●
Plain Panel	18mm / 2400x 650mm	●	●	×	●
Plain Panel	18mm / 2400x 900mm	●	●	×	●
Plain Panel	Made to Measure per m2	×	●	●	●
T&G Panel	Made to Measure per m2	×	●	●	●

*Unfinished MTM - These items will be supplied as unfinished MDF.



Plain Panel / 18mm Thick

EXS PTO MTM

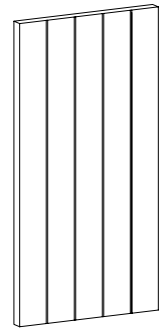

T&G Panel / 18mm Thick

MTM

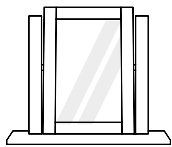

Single Square Mirror
485mm (W) x 570mm (H)

EXS PTO

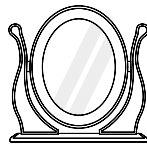

Single Oval Mirror
485mm (W) x 570mm (H)

EXS PTO



Headboard
MTM per m2. / Supplied as a flat panel

MTM

Gladstone | MDF Matt Painted Door (Smooth)

MDF Painted | Ex.Stock and MTM



Door Specification

Description	Faux In-frame slab door style with 28mm border
Finish	Smooth Matt Painted Finish
Door Thickness	18mm Thick
Base Material	MDF Core
Edge	1mm ABS Edge



31 Painted Colours



Available Painted to Order standard sizes.



Available Made to Measure



Available Primed / Unfinished*



Smooth Surface



Gladstone | Colours / Finishes



Primed



White

Colours swatches shown are approximate.

See Painted Swatch Book for true colour match.

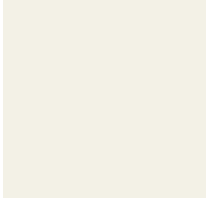

Porcelano

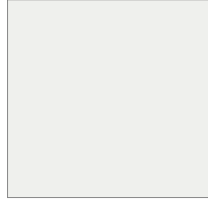

Highland Grey

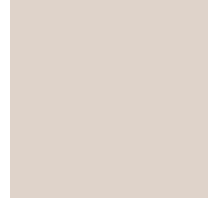

Cashmere



Sea Breeze

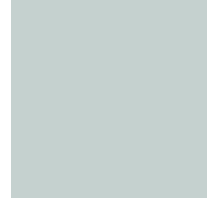

Light Blue

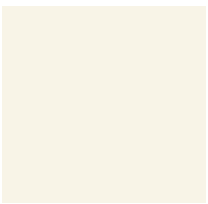

Ivory

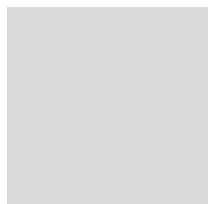

Light Grey



French Chalk



Sage



Denim

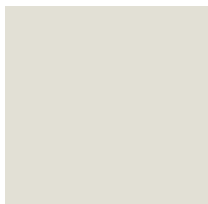

Mussel

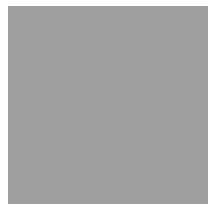

Dust Grey



Heritage Pink



Liberty Green



Eiffel Blue



Dakar

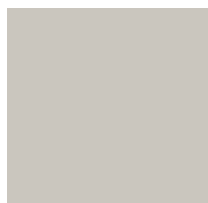

Pebble

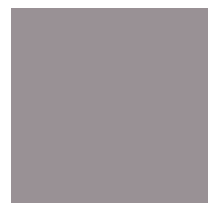

French Lavender



Moss Green



Nautical

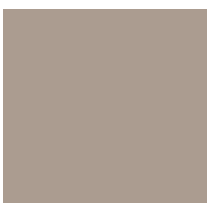

Stone Grey

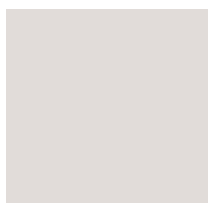

Taupe Grey

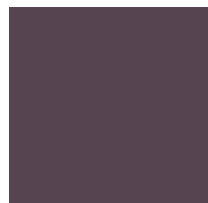

Foraged Fruit



Heritage Green



Marine Blue



Honeycomb

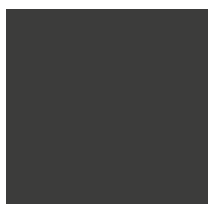

Graphite



Heritage Red

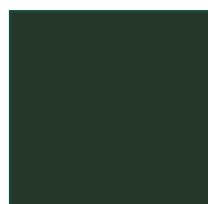

Conifer



Indigo

Gladstone | Door and Drawer Sizes

MDF Painted | Ex:Stock and MTM



Kitchen Door Sizes				
Doors and Drawer Sizes		MTM	Curved Door sizes	MTM
115 x 596	570 x 446		715 x 300	
140 x 296	570 x 496		895 x 300	
140 x 396	570 x 596		1245 x 300	
140 x 446	645 x 596		1965 x 300	
140 x 496	715 x 146			
140 x 596	715 x 246			
140 x 796	715 x 275			
140 x 896	715 x 296			
140 x 996	715 x 315			
175 x 396	715 x 346			
175 x 496	715 x 396			
175 x 596	715 x 446			
283 x 496	715 x 496			
283 x 596	715 x 546			
283 x 796	715 x 596			
283 x 896	895 x 296			
283 x 996	895 x 396			
355 x 496	895 x 446			
355 x 596	895 x 496			
355 x 760	895 x 596			
355 x 796	980 x 596			
355 x 896	1060 x 396			
355 x 996	1060 x 496			
450 x 596	1060 x 596			
495 x 396	1245 x 296			
495 x 596	1245 x 396			
570 x 296	1245 x 496			
570 x 396	1245 x 596			

Bedroom Door Sizes				
Doors and Drawer Sizes		MTM	Curved Door Sizes	MTM
215 x 296	1495 x 596		1495 x 300	
215 x 396	1595 x 296		1595 x 300	
215 x 446	1595 x 396		2150 x 300	
215 x 496	1595 x 446		2250 x 300	
215 x 546	1595 x 496			
215 x 596	1595 x 596			
215 x 796	1735 x 296			
215 x 896	1735 x 396			
215 x 996	1735 x 446			
415 x 296	1735 x 496			
415 x 396	1735 x 596			
415 x 446	2150 x 296			
415 x 496	2150 x 396			
415 x 596	2150 x 446			
535 x 296	2150 x 496			
535 x 396	2150 x 596			
535 x 446	2250 x 296			
535 x 496	2250 x 396			
535 x 596	2250 x 446			
650 x 296	2250 x 496			
650 x 396	2250 x 596			
650 x 446	2400 x 296			
650 x 496	2400 x 396			
650 x 596	2400 x 446			
1495 x 296	2400 x 496			
1495 x 396	2400 x 596			
1495 x 446				
1495 x 496				

Non-Standard Kitchen Door Sizes - Priced next door size up.

Angled Kitchen Door Sizes - Priced as door size plus 50%.

Primed MTM Sizes are not available.

Unfinished MTM -These doors will be supplied as raw MDF.

Curved Kitchen Doors available any height up to 2250mm

Non-Standard Curved Kitchen Door Sizes - Priced next door size up.

MTM Plain Kitchen Frames - Priced as door size plus 35% (Supplied Unglazed).

Drilling - Additional charge per hole.

Non-Standard Bedroom Door Sizes - Priced next door size up.

Angled Bedroom Door Sizes - Priced as door size plus 50%.

Primed MTM Sizes are not available.

Unfinished MTM -These doors will be supplied as raw MDF.

Curved Bedroom Doors available any height up to 2250mm

Non-Standard Curved Bedroom Door Sizes - Priced next door size up.

MTM Plain Bedroom Frames - Priced as door size plus 35% (Supplied Unglazed).

Drilling - Additional charge per hole.

Gladstone | Handleless Rail System Door Sizes



Plain Panel
(18mm thick)

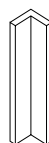

Internal Corner Post
685 x 70 x 70mm



External Corner Post
685 x 46 x 46mm



Handleless Rail System Door Sizes				
Kitchen Door Sizes		Bedroom Door Sizes		
160 x 296	490 x 296	1400 x 263	1500 x 413	2150 x 563
160 x 396	490 x 396	1400 x 281	1500 x 431	2150 x 581
160 x 446	490 x 446	1400 x 313	1500 x 463	2250 x 263
160 x 496	490 x 496	1400 x 331	1500 x 481	2250 x 281
160 x 596	490 x 596	1400 x 363	1500 x 513	2250 x 313
160 x 796	685 x 146	1400 x 381	1500 x 531	2250 x 331
160 x 896	685 x 296	1400 x 413	1500 x 563	2250 x 363
160 x 996	685 x 315	1400 x 431	1500 x 581	2250 x 381
325 x 496	685 x 346	1400 x 463	2150 x 263	2250 x 413
325 x 596	685 x 396	1400 x 481	2150 x 281	2250 x 431
325 x 796	685 x 446	1400 x 513	2150 x 313	2250 x 463
325 x 896	685 x 496	1400 x 531	2150 x 331	2250 x 481
325 x 996	685 x 596	1400 x 563	2150 x 363	2250 x 513
		1400 x 581	2150 x 381	2250 x 531
		1500 x 263	2150 x 413	2250 x 563
		1500 x 281	2150 x 431	2250 x 581
		1500 x 313	2150 x 463	
		1500 x 331	2150 x 481	
		1500 x 363	2150 x 513	
		1500 x 381	2150 x 531	

Drilling - Additional charge per hole.

Save time & money with **automatic pricing** through our online ordering service.

Order online at weborders.osdoors.com

Important: Always ensure doors are shielded from heat sources through the use of heat deflectors.

See page 226 for full range of heat deflector sizes.

Gladstone | Door Specifications

MDF Painted | Ex.Stock and MTM

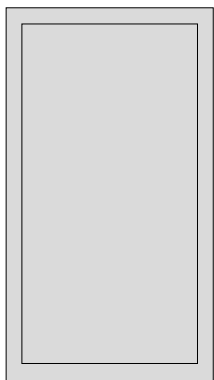

Gladstone Kitchen Door

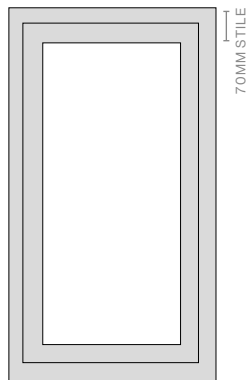

Gladstone Kitchen Frame
(Unglazed) 70mm stile

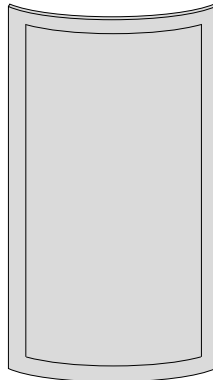

Gladstone Kitchen
Curved Door



Gladstone Pan Drawer



Gladstone Drawer

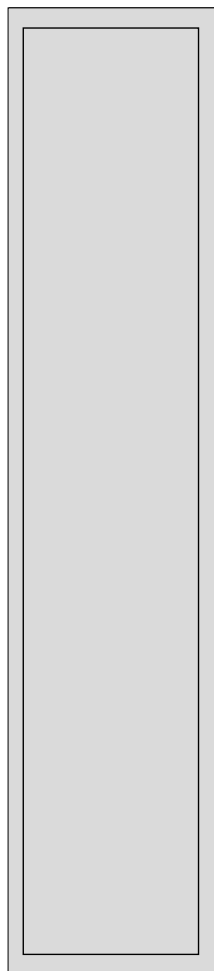

Gladstone
Bedroom Door

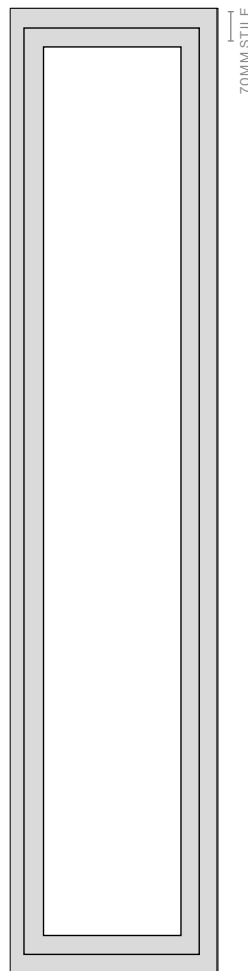

Gladstone Bedroom
Full Open Frame

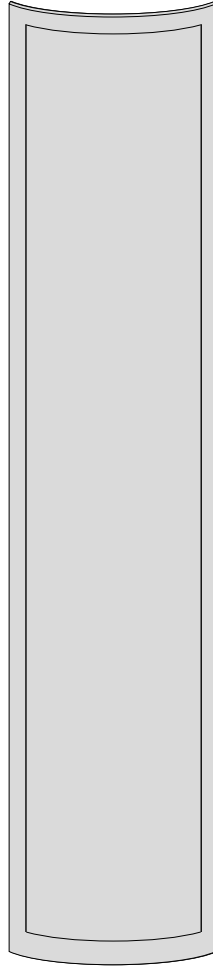

Gladstone Bedroom
Curved Door

Gladstone Kitchen Doors:

Door sizes between 250mm - 1734mm high are supplied flat panel as standard. Minimum Kitchen Door width is 246mm.

Gladstone Drawers:

Drawer sizes between 100mm - 282mm high are supplied flat panel as standard. Minimum Drawer width is 246mm.

Pan Drawer sizes between 250mm - 282mm high are supplied flat panel as standard. Minimum Pan Drawer width is 246mm.

Please note it's important to specify either Door, Drawer or Pan Drawer when ordering to ensure your order is processed correctly.

Gladstone Frames:

Frames between 250mm - 2400mm high are supplied flat panel Full Open Frames with a 70mm stile as standard.

Top Open Frames between 1735mm - 2400mm high are supplied with a double mid-rail which position is variable for each order (please specify required dimensions of split dimensions). The mid rail is measured from the base of the door to the centre of the mid rail unless otherwise specified.

If you require a Top Open Frame this must be clearly stated when ordering, and full details on sizes required must be included.

Gladstone Curved Doors:

Curved doors are made to suit 300mm x 300mm cabinets only. Height availability ranges from 570mm up to 2250mm.

Gladstone Bedroom Doors:

Bedroom Door sizes between 1735mm - 2400mm high are supplied flat panel as standard. Minimum Bedroom Door width is 246mm.

Drilling:

All door styles are supplied un-drilled unless requested by the customer. If drilling is required, drilling instructions must clearly state full dimensions for all holes required.

Gladstone | Technical Specifications

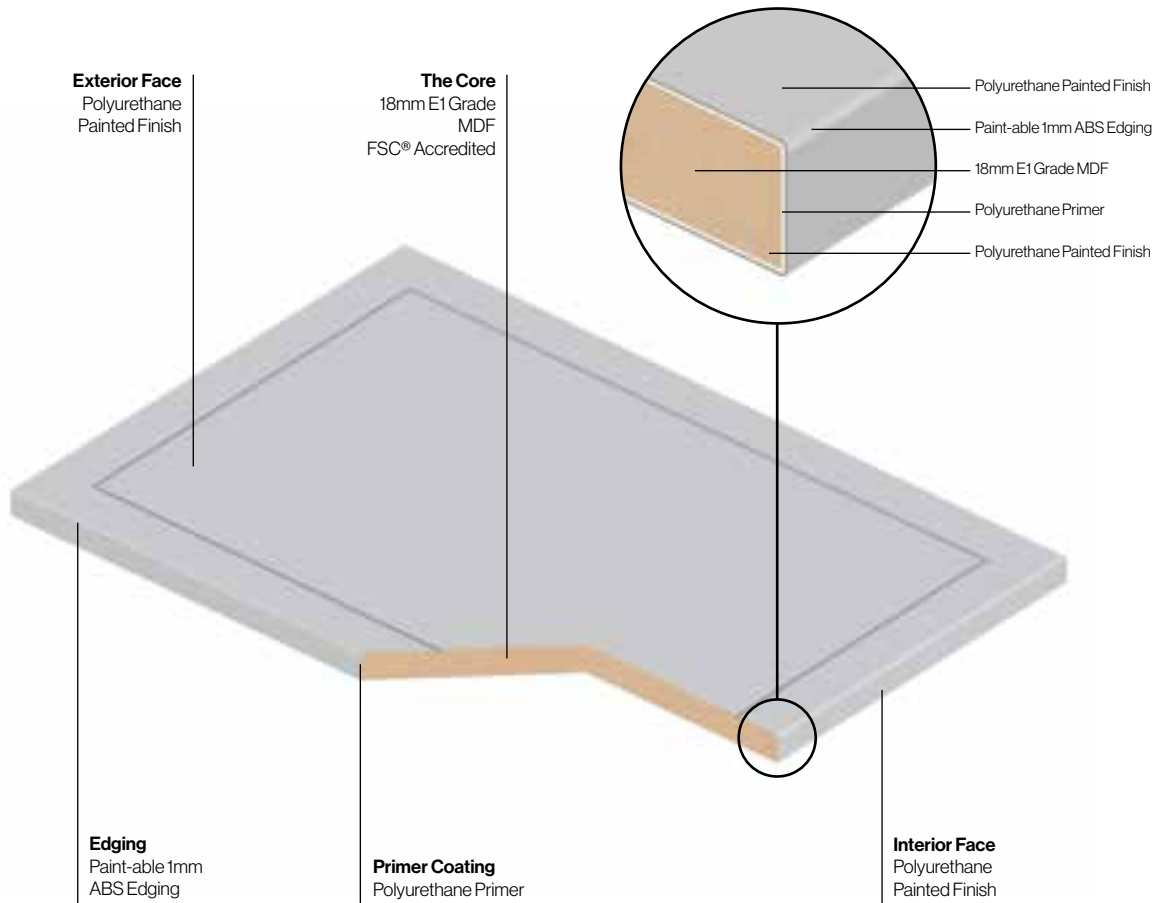

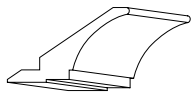

Classic Cornice
102mm (W) x 70mm (H)
3050mm Lengths

EXS PTO



Curved Classic Cornice
419mm (L) x 419mm (W)
x 70mm (H)

EXS PTO

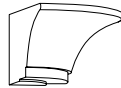

Classic Cornice Quadrant
98mm (L) x 98mm (W)
x 70mm (H)

EXS PTO

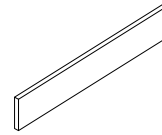

Plain Plinth
18mm (W) x 150mm (H)
3050mm Lengths

EXS PTO

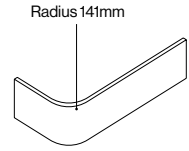

Curved Plain Plinth
540mm (L) x 232mm (W)
x 150mm (H)

EXS PTO

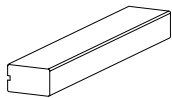

Modern Cornice / Pelmet
50mm (W) x 30mm (H)
3050mm Lengths

EXS PTO

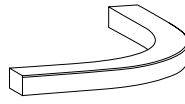

Curved Modern Cornice / Pelmet
350mm (L) x 350mm (W)
x 30mm (H)

EXS PTO

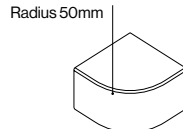

Modern Cornice / Pelmet Quadrant
50mm (L) x 50mm (W) x 30mm (H)

EXS PTO

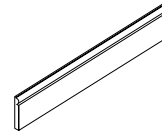

Torus Plinth
18mm (W) x 150mm (H)
3050mm Lengths

EXS PTO



Curved Torus Plinth
300mm (L) x 300mm (W)
x 150mm (H)

EXS PTO

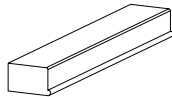

Under Cornice
50mm (W) x 30mm (H)
3050mm Lengths

EXS PTO

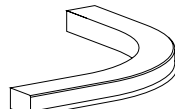

Curved Under Cornice
350mm (L) x 350mm (W)
x 30mm (H)

EXS PTO

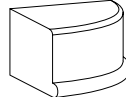

Under Cornice Quadrant
53mm (L) x 53mm (W)
x 30mm (H)

EXS PTO

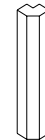

Corner Post
30mm (L) x 30mm (W)
x 720mm (H)

EXS PTO

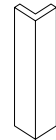

MTM Corner Post
715mm (150 x 150mm Max)

MTM

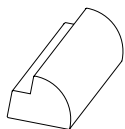

Radius Profile (R 48mm)
70mm (W) x 50mm (H)
3050mm Lengths

EXS PTO

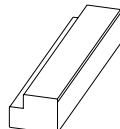

Square Base Pilaster
70mm (W) x 50mm (H)
3050mm Lengths

EXS PTO

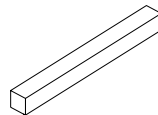

Square Base Pilaster Insert
965mm (L) x 18mm (W)
x 18mm (H)

EXS PTO

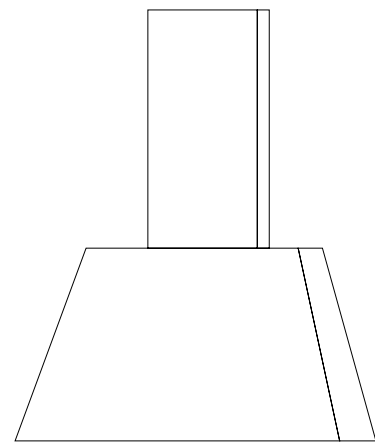

Chimney Canopy
900mm (W) x 400mm (D) x 1130mm (H)

PTO

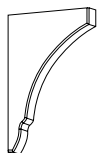

Shelf Bracket
100mm (L) x 18mm (W)
x 150mm (H)

EXS PTO

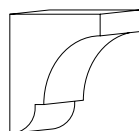

Corbel
125mm (L) x 90mm (W)
x 165mm (H)

EXS PTO



French Mantle Corbel
350mm (L) x 90mm (W)
x 600mm (H)

EXS PTO

Gladstone | Accessories

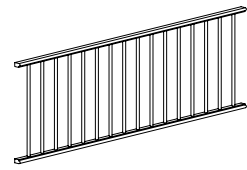
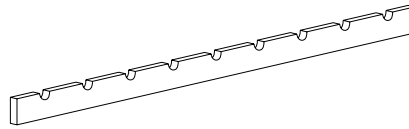

Plate Cot (Pair) /
1000mm (L) x 23mm (W) x 308mm (H)

EXS PTO



Wine Rack Rail
1200mm (L) x 18mm (W) x 60mm (H)

EXS PTO



Touch Up Paint
Available 30ml or 1 Litre volumes.

Panel	Size MM	Primed Ex.Stock	Painted To Order	Unfinished MTM*	Painted MTM
Plain Panel	18mm / 785 x 360mm	●	●	●	●
Plain Panel	18mm / 900 x 360mm	●	●	●	●
Plain Panel	18mm / 900x 650mm	●	●	●	●
Plain Panel	18mm / 900 x 864mm	●	●	●	●
Plain Panel	18mm / 900 x 1160mm	●	●	●	●
Plain Panel	18mm / 900 x 1200mm	●	●	●	●
Plain Panel	18mm / 965 x 360mm	●	●	●	●
Plain Panel	18mm / 2400 x 360mm	●	●	●	●
Plain Panel	18mm / 2400x 650mm	●	●	●	●
Plain Panel	18mm / 2400x 900mm	●	●	●	●
Plain Panel	Made to Measure per m2	×	●	●	●
T&G Panel	Made to Measure per m2	×	●	●	●



Plain Panel / 18mm Thick

EXS PTO MTM

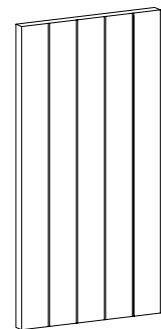

T&G Panel / 18mm Thick

MTM

*Unfinished MTM - These items will be supplied as unfinished MDF.

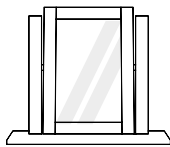

Single Square Mirror
485mm (W) x 570mm (H)

EXS PTO

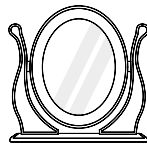

Single Oval Mirror
485mm (W) x 570mm (H)

EXS PTO



Headboard
MTM per m2. / Supplied as a flat panel

MTM

Crafted Aesthetic. MTM Flexibility. One Simple Price. Choose Timber Painted.



With 6 Solid Timber Painted Door Styles and a wide colour range to choose from, you can give your customers the kitchen they've always wanted. Better yet, they all retail at the same price and are now available Made to Measure.

NEW

NEW



Campbell
Solid Timber Painted
Page 164



Rainey
Solid Timber Painted
Page 170



Edison
Solid Timber Painted
Page 176



Monroe
Solid Timber Painted
Page 182



Albany
Solid Timber Painted
Page 188



Hampton
Solid Timber Painted
Page 194



Greenwich Ash
Solid Timber Painted
Page 200



Greenwich Oak
Solid Timber Painted
Page 206



Hyde
MDF Matt Painted (Grained)
Page 212



Campbell | Solid Timber Matt Painted Door

Solid Timber Painted | Ex.Stock and MTM



Door Specification

Description	Plain Shaker Door with 75mm Stiles
Finish	Matt Painted Finish
Door Thickness	20mm Thick
Base Material	Solid Ash Core with Veneered Centre Panel
Edge	1mm Bevelled Edge.



32 Painted Colours



Available Made to Order.



Available Painted to Order standard sizes.



Available Made to Measure



Solid Ash Timber



Campbell Door



Campbell Frame



Campbell Curved Door



Campbell Pan Drawer

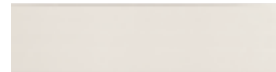

Campbell Drawer

Campbell | Colours / Finishes



Primed



White

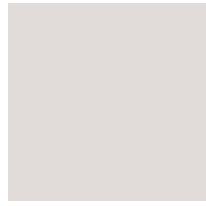

Taupe

Colours swatches shown are approximate.

See Painted Swatch Book for true colour match.

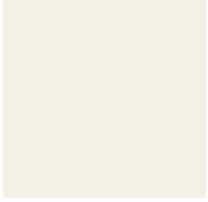

Porcelano

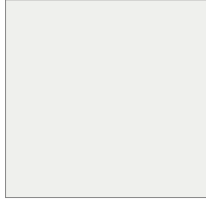

Highland Grey

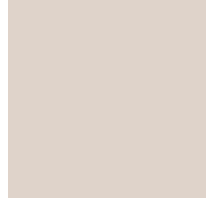

Cashmere



Sea Breeze

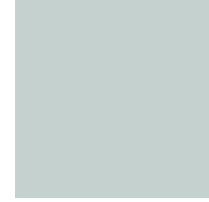

Light Blue

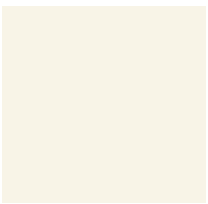

Ivory

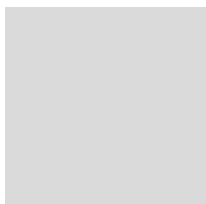

Light Grey



French Chalk



Sage



Denim

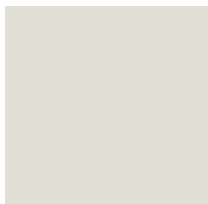

Mussel

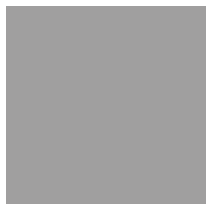

Dust Grey



Heritage Pink



Liberty Green



Eiffel Blue



Dakar

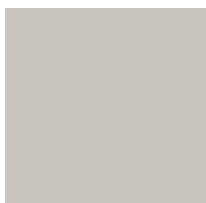

Pebble

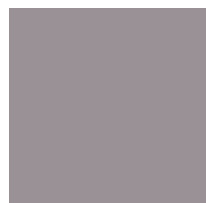

French Lavender



Moss Green



Nautical

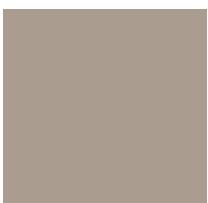

Stone Grey

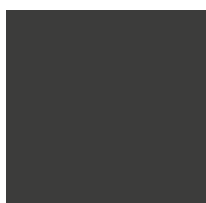

Graphite

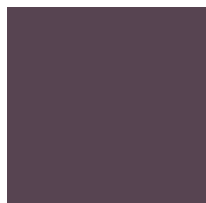

Foraged Fruit



Heritage Green



Marine Blue



Honeycomb



Carbon Black



Heritage Red

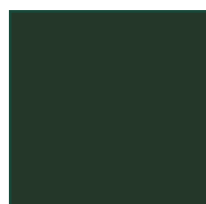

Conifer



Indigo

Solid Timber Painted | Ex.Stock and MTM

Campbell | Door and Drawer Sizes

Solid Timber Painted | Ex Stock and MTM



Kitchen Door Sizes						
Doors Sizes		PTO	MTM	Curved Door sizes		PTO
115 x 596	570 x 396			716 x 300		
140 x 296	570 x 446			896 x 300		
140 x 396	570 x 496					
140 x 446	570 x 596					
140 x 496	645 x 596					
140 x 596	716 x 146					
140 x 796	716 x 256					
140 x 896	716 x 275					
140 x 996	716 x 296					
176 x 396	716 x 315					
176 x 496	716 x 346					
176 x 596	716 x 396					
284 x 496	716 x 446					
284 x 596	716 x 496					
284 x 796	716 x 546					
284 x 896	716 x 596					
284 x 996	896 x 296					
356 x 496	896 x 396					
356 x 596	896 x 446					
356 x 796	896 x 496					
356 x 896	896 x 596					
356 x 996	980 x 596					
450 x 596	1245 x 296					
496 x 396	1245 x 396					
496 x 596	1245 x 496					
570 x 296	1245 x 596					

Plain Frame Sizes			
		PTO	MTM
716 x 396	(Glazed)		
716 x 496	(Glazed)		
896 x 496	(Glazed)		
1060 x 496	(Glazed)		

Handleless Rail System / Door Sizes			
Kitchen Door Sizes			MTM
160 x 296	325 x 596	685 x 146	
160 x 396	325 x 796	685 x 296	
160 x 446	325 x 896	685 x 315	
160 x 496	325 x 996	685 x 346	
160 x 596	490 x 296	685 x 396	
160 x 796	490 x 396	685 x 446	
160 x 896	490 x 446	685 x 496	
160 x 996	490 x 496	685 x 596	
325 x 496	490 x 596		

Drilling - Additional charge per hole.

Non-Standard Kitchen Door Sizes - Priced as MTM

Angled Doors are not available.

Primed MTM Sizes are not available.

MTM timber doors cannot be cancelled once ordered.

MTM Timber doors are non-returnable.

Non-Standard Curved Door Sizes are not available.

Concave Doors are not available.

Standard Plain Frame Sizes - Supplied Glazed.

Non Standard Plain Frame Sizes - Supplied Unglazed.

Non Standard Plain Frame Sizes - Priced as door size plus 35%.

Non Standard Top Open Feature Frame Sizes - Priced as door size plus 35%.

Georgian Frame Sizes are not available.

Drilling - Additional charge per hole.

Solid Timber Doors:

Door sizes between 283mm - 1245mm high are supplied as single panels as standard. Maximum Door Width is 996mm. Minimum Door Width is 246mm.

Stile width will be reduced as necessary for Doors sized below 296mm wide.

Angled doors are not available.

Solid Timber Drawers:

Drawer sizes between 50mm - 200mm high are supplied as flat panels as standard. Maximum Drawer width is 1196mm. Minimum Drawer width is 100mm.

Pan Drawer sizes between 283mm - 400mm high are supplied as single panels as standard. Maximum Pan Drawer width is 1196mm. Minimum Pan Drawer width is 246mm.

Stile width will be reduced as necessary for Pan Drawers sized below 296mm wide.

Please note it's important to specify either Door, Drawer or Pan Drawer when ordering to ensure your order is processed correctly.

Solid Timber Frames:

Plain Frame sizes between 283mm - 1245mm high are supplied as single panels as standard. Maximum Plain Frame width is 996mm. Minimum Plain Frame width is 246mm.

Stile width will be reduced as necessary for Plain Frames sized below 296mm wide.

Standard Kitchen Frame sizes are supplied glazed. Non Standard Kitchen and Bedroom Frame sizes are supplied unglazed. Unglazed frames are rebated on the reverse side and supplied with a glazing gasket.

MTM Georgian Frames not available. Angled Frames are not available.

Solid Timber Curved Doors:

Solid Timber Curved doors are made to suit 300 x 300mm cabinets only. Solid Timber Curved Doors are available in standard listed sizes only.

MTM Solid Timber Doors are not available. Concave doors are not available.

Drilling:

All door styles are supplied un-drilled unless requested by the customer. If drilling is required, drilling instructions must clearly state full dimensions for all holes required.

Campbell Door Cross Section

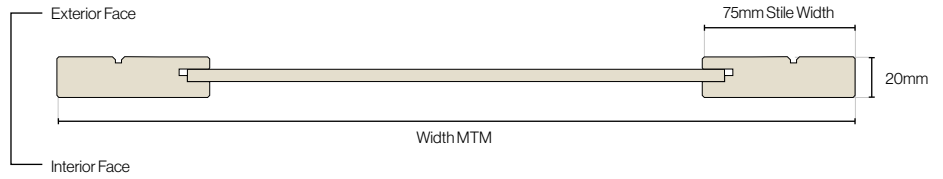

Campbell Stile Cross Section

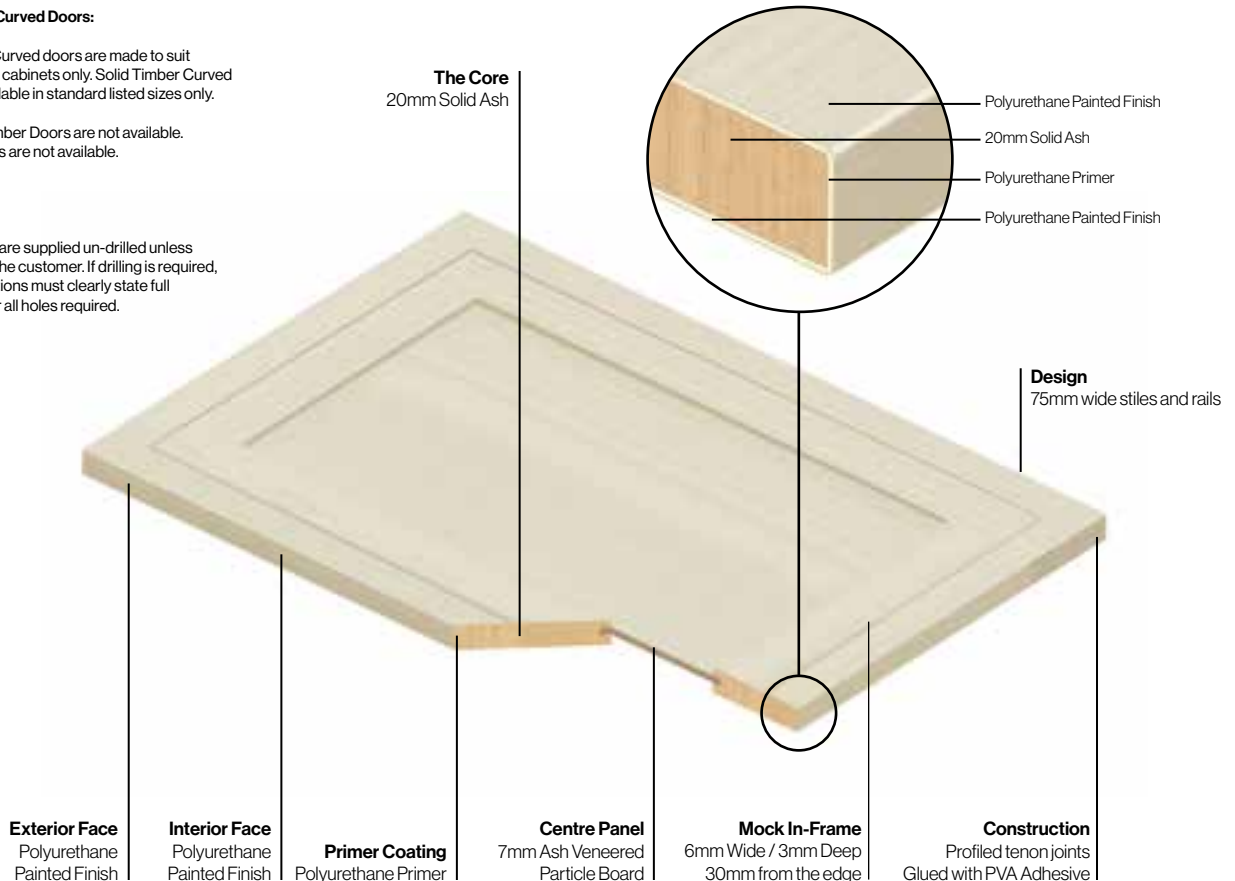
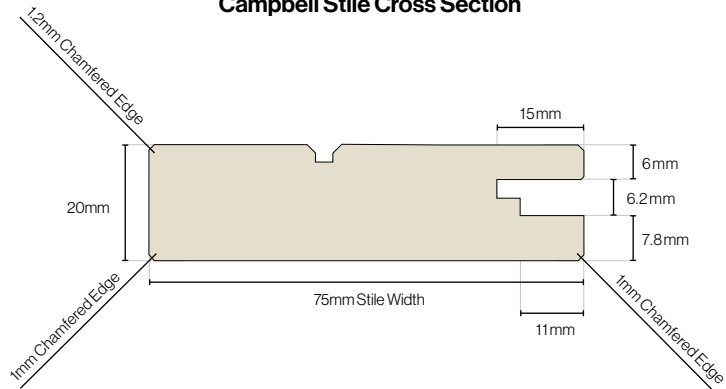

Campbell | Accessories

Solid Timber Painted | Ex:Stock and MTM

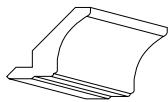

Classic Cornice (Grained)
76mm (W) x 63mm (H)
3050mm Lengths

EXS PTO

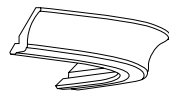

Curved Classic Cornice
364mm (L) x 364mm (W)
x 63mm (H)

EXS PTO

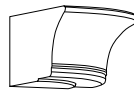

Classic Cornice Quadrant
84mm (L) x 84mm (W)
x 63mm (H)

EXS PTO

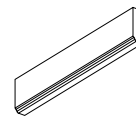

Tangent Light Pelmet
18mm (W) x 57mm (H)
3050mm Lengths

EXS PTO

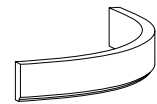

Curved Tangent Pelmet
300mm (L) x 300mm (W)
x 57mm (H)

EXS PTO

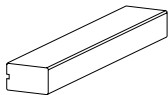

Modern Cornice / Pelmet
50mm (W) x 30mm (H)
3050mm Lengths

EXS PTO

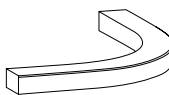

Curved Modern Cornice Pelmet
350mm (L) x 350mm (W)
x 30mm (H)

EXS PTO

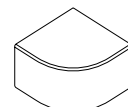

Modern Cornice / Pelmet Quadrant
50mm (L) x 50mm (W)
x 30mm (H)

EXS PTO

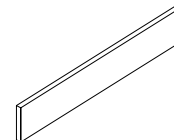

Plain Plinth
18mm (W) x 150mm (H)
2850mm Lengths

EXS PTO



Curved Plain Plinth
540mm (L) x 232mm (W)
x 150mm (H)

EXS PTO



Turned Pilaster
30mm (L) x 30mm (W)
x 720mm (H)

EXS PTO



Corner Post
30mm (L) x 30mm (W)
x 720mm (H)

EXS PTO

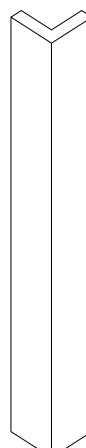

MTM Corner Post
715mm (150 x 150mm Max)

MTM

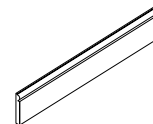

Torus Plinth
18mm (W) x 150mm (H)
3050mm Lengths

EXS PTO



Radius Profile
(R 48mm) 70mm (W) x 50mm (H)
3050mm Lengths

EXS PTO

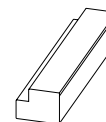

Square Base Pilaster
965mm (L) x 70mm (W)
x 50mm (H)

EXS PTO

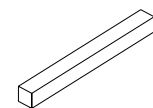

Square Base Pilaster Insert
965mm (L) x 19mm (W)
x 19mm (H)

EXS PTO

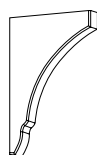

Shelf Bracket
100mm (L) x 18mm (W)
x 150mm (H)

EXS PTO

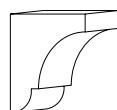

Corbel
125mm (L) x 90mm (W)
x 165mm (H)

EXS PTO



French Mantle Corbel
350mm (L) x 90mm (W)
x 600mm (H)

EXS PTO

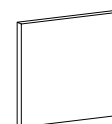

Corbel Back Panel
284mm (W) x 18mm (W)
x 296mm (H)

EXS PTO

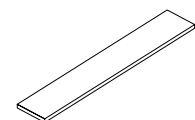

Mantle Shelf
1784mm (L) x 180mm (W)
x 18mm (H)

EXS PTO

Campbell | Accessories

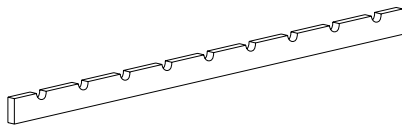

Wine Rack Rail
1200mm (L) x 18mm (W) x 60mm (H)

EXS PTO

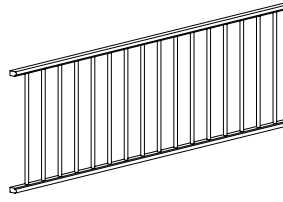
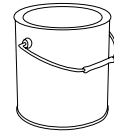

Plate Cot (Pair)
1000mm (L) x 23mm (W) x 308mm (H)

EXS PTO



Touch Up Paint
Available 30ml or 1Litre volumes.

Solid Timber Painted | Ex:Stock and MTM

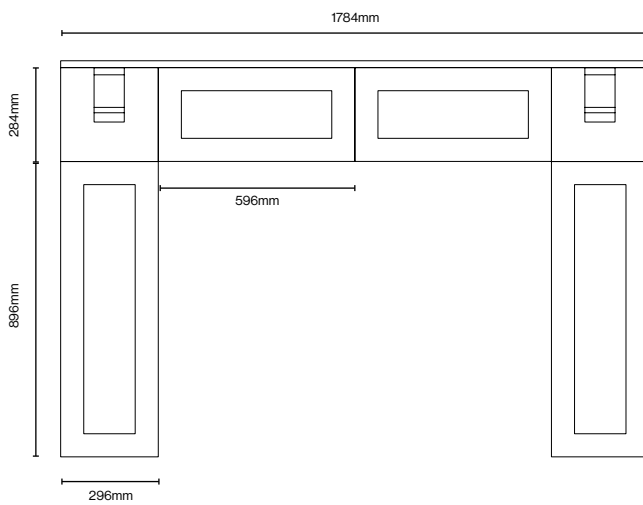

Campbell Overmantle Kit
Includes: 2 x Classic Corbels / 2 x Corbel back Panels / 2 x Doors 896 x 296mm / 2 x Drawers 284 x 596mm / 1 x Mantle Shelf

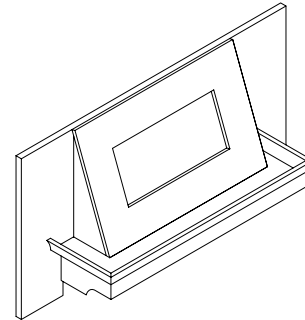

Modern Canopy
1000mm (W) x 228mm (D) x 525mm (H)

EXS PTO

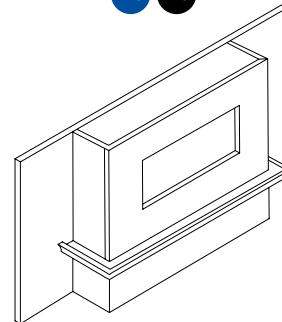

Classic Canopy
1000mm (W) x 215mm (D) x 485mm (H)

MTM

Panel	Size MM	Primed Ex:Stock	Painted To Order	Unfinished MTM*	Painted MTM
Plain / T&G Panel	18mm / 785 x 360mm	●	●	●	●
Plain / T&G Panel	18mm / 900 x 360mm	●	●	●	●
Plain / T&G Panel	18mm / 900 x 650mm	●	●	●	●
Plain / T&G Panel	18mm / 900 x 864mm	●	●	●	●
Plain / T&G Panel	18mm / 900 x 1160mm	●	●	●	●
Plain / T&G Panel	18mm / 900 x 1200mm	●	●	●	●
Plain / T&G Panel	18mm / 965 x 360mm	●	●	●	●
Plain / T&G Panel	18mm / 2400 x 360mm	●	●	●	●
Plain / T&G Panel	18mm / 2400 x 650mm	●	●	●	●
Plain / T&G Panel	18mm / 2400 x 900mm	●	●	●	●
Plain / T&G Panel	Made to Measure per m2	×	●	●	●

*Unfinished MTM - These items will be supplied as unfinished MDF.



Plain Panel / 18mm Thick

EXS PTO MTM

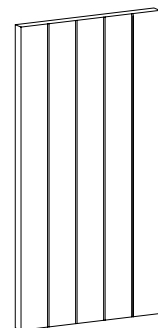

T&G Panel / 18mm Thick

EXS PTO MTM

EXS Available Primed Ex:Stock. Ready for 48h despatch.

PTO Available Painted to Order standard sizes.

MTM Available Made to Measure Unfinished / Painted.

Rainey | Solid Timber Matt Painted Door

Solid Timber Painted | Ex.Stock and MTM



Door Specification	
Description	Beaded Shaker Door with 84mm Stiles
Finish	Matt Painted Finish
Door Thickness	20mm Thick
Base Material	Solid Ash Core with Veneered Centre Panel



32 Painted Colours



Available Made to Order.



Available Painted to Order standard sizes.



Available Made to Measure



Solid Ash Timber



Rainey Door



Rainey Georgian Frame



Rainey Curved Door



Rainey Pan Drawer

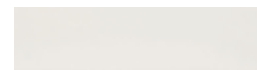

Rainey Drawer

Rainey | Colours / Finishes



Primed



White

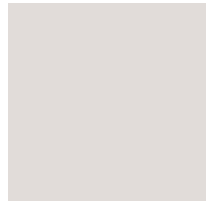

Taupe

Colours swatches shown are approximate.

See Painted Swatch Book for true colour match.

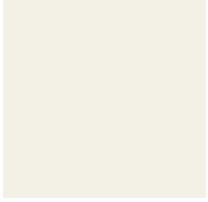

Porcelano

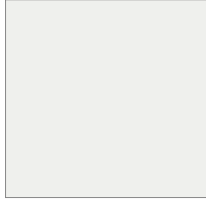

Highland Grey

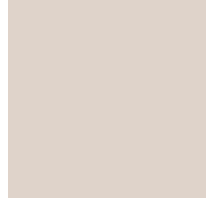

Cashmere



Sea Breeze

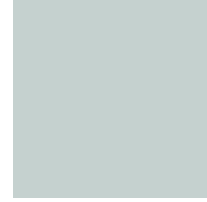

Light Blue

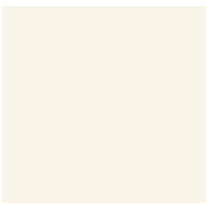

Ivory

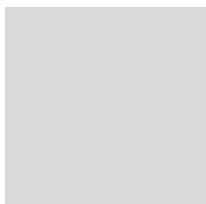

Light Grey



French Chalk



Sage



Denim

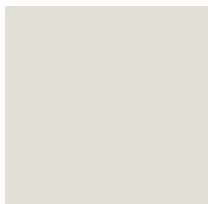

Mussel

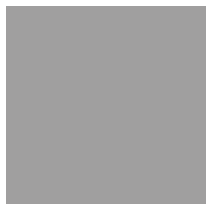

Dust Grey



Heritage Pink



Liberty Green



Eiffel Blue



Dakar

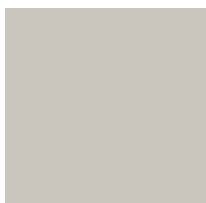

Pebble

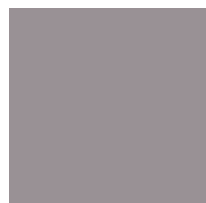

French Lavender



Moss Green



Nautical

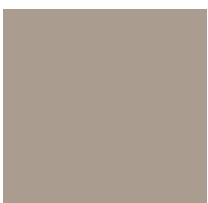

Stone Grey

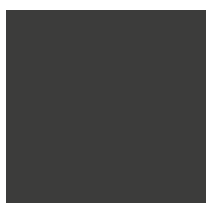

Graphite

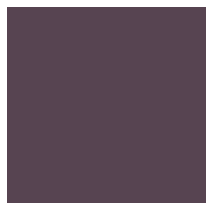

Foraged Fruit



Heritage Green



Marine Blue



Honeycomb



Carbon Black



Heritage Red

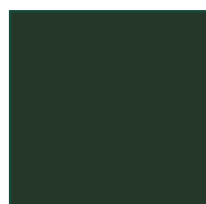

Conifer



Indigo

Rainey | Door and Drawer Sizes

Solid Timber Painted | Ex.Stock and MTM



Kitchen Door Sizes					
Doors Sizes		PTO	MTM	Curved Door sizes	PTO
115 x 596	570 x 396			716 x 300	
140 x 296	570 x 446			896 x 300	
140 x 396	570 x 496				
140 x 446	570 x 596				
140 x 496	645 x 596				
140 x 596	716 x 146				
140 x 796	716 x 256				
140 x 896	716 x 275				
140 x 996	716 x 296				
176 x 396	716 x 315				
176 x 496	716 x 346				
176 x 596	716 x 396				
284 x 496	716 x 446				
284 x 596	716 x 496				
284 x 796	716 x 546				
284 x 896	716 x 596				
284 x 996	896 x 296				
356 x 496	896 x 396				
356 x 596	896 x 446				
356 x 796	896 x 496				
356 x 896	896 x 596				
356 x 996	980 x 596				
450 x 596	1245 x 296				
496 x 396	1245 x 396				
496 x 596	1245 x 496				
570 x 296	1245 x 596				
				Plain Frame Sizes	MTM
				716 x 396 (Unglazed)	
				716 x 496 (Unglazed)	
				896 x 496 (Unglazed)	
				1060 x 496 (Unglazed)	
				Georgian Frame Sizes	PTO
				716 x 396 (Glazed)	
				716 x 496 (Glazed)	
				896 x 496 (Glazed)	
				1060 x 496 (Glazed)	

Handleless Rail System / Door Sizes			
Kitchen Door Sizes			MTM
160 x 296	325 x 596	685 x 146	
160 x 396	325 x 796	685 x 296	
160 x 446	325 x 896	685 x 315	
160 x 496	325 x 996	685 x 346	
160 x 596	490 x 296	685 x 396	
160 x 796	490 x 396	685 x 446	
160 x 896	490 x 446	685 x 496	
160 x 996	490 x 496	685 x 596	
325 x 496	490 x 596		

Drilling - Additional charge per hole.

Non-Standard Kitchen Door Sizes - Priced as MTM
Angled Doors are not available.

Primed MTM Sizes are not available.
MTM timber doors cannot be cancelled once ordered.
MTM Timber doors are non-returnable.

Non-Standard Curved Door Sizes are not available.
Concave Doors are not available.

Standard Georgian Frame Sizes - Supplied Glazed.
Non Standard Georgian Frame Sizes are not available.
Non Standard Plain Frame Sizes - Supplied Unglazed.
Non Standard Plain Frame Sizes - Priced as door size plus 35%.
Non Standard Top Open Feature Frame Sizes - Priced as door size plus 35%.

Drilling - Additional charge per hole.

Rainey | Technical Specification

Solid Timber Doors:

Door sizes between 283mm - 1245mm high are supplied as single panels as standard. Maximum Door Width is 996mm. Minimum Door Width is 246mm.

Stile width will be reduced as necessary for Doors sized below 296mm wide.

Angled doors are not available.

Solid Timber Drawers:

Drawer sizes between 50mm - 200mm high are supplied as flat panels as standard. Maximum Drawer width is 1196mm. Minimum Drawer width is 100mm.

Pan Drawer sizes between 283mm - 400mm high are supplied as single panels as standard. Maximum Pan Drawer width is 1196mm. Minimum Pan Drawer width is 246mm.

Stile width will be reduced as necessary for Pan Drawers sized below 296mm wide.

Please note it's important to specify either Door, Drawer or Pan Drawer when ordering to ensure your order is processed correctly.

Solid Timber Frames:

Plain Frame sizes between 283mm - 1245mm high are supplied as single panels as standard. Maximum Plain Frame width is 996mm. Minimum Plain Frame width is 246mm.

Stile width will be reduced as necessary for Plain Frames sized below 296mm wide.

Standard Kitchen Frame sizes are supplied glazed. Non Standard Kitchen and Bedroom Frame sizes are supplied unglazed. Unglazed frames are rebated on the reverse side and supplied with a glazing gasket.

MTM Georgian Frames not available. Angled Frames are not available.

Solid Timber Curved Doors:

Solid Timber Curved doors are made to suit 300 x 300mm cabinets only. Solid Timber Curved Doors are available in standard listed sizes only.

MTM Solid Timber Doors are not available. Concave doors are not available.

Drilling:

All door styles are supplied un-drilled unless requested by the customer. If drilling is required, drilling instructions must clearly state full dimensions for all holes required.

Rainey Door Cross Section

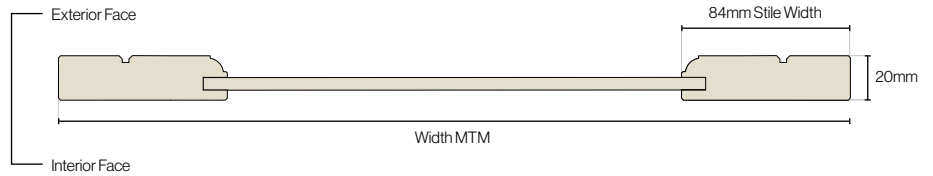

Rainey Stile Cross Section

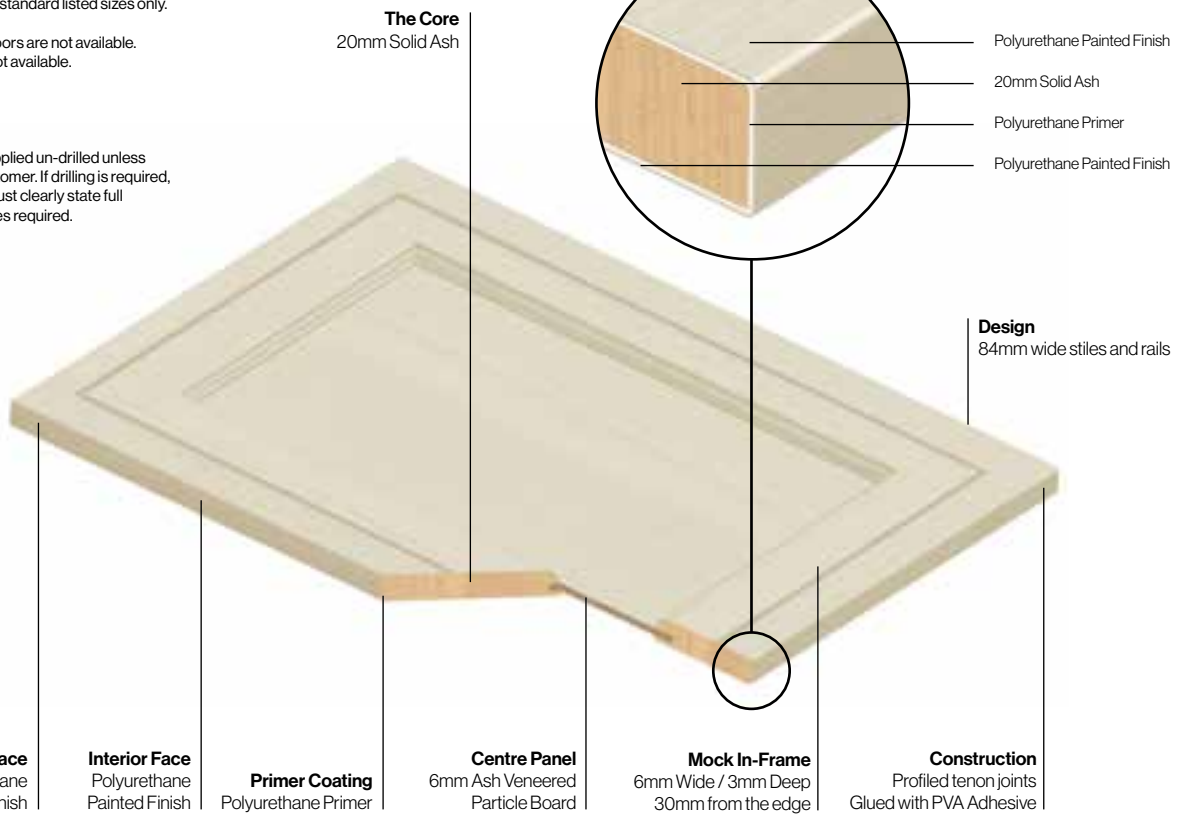
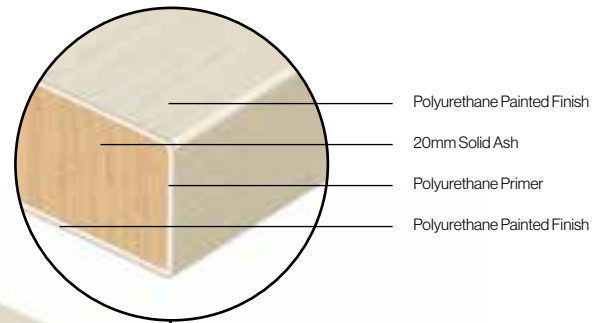
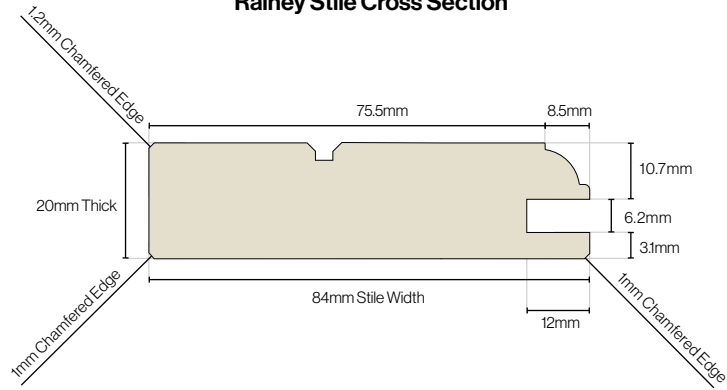

Rainey | Accessories

Solid Timber Painted | Ex:Stock and MTM

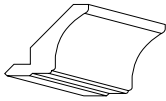

Classic Cornice (Grained)
76mm (W) x 63mm (H)
3050mm Lengths

EXS PTO

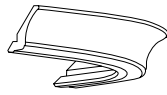

Curved Classic Cornice
364mm (L) x 364mm (W)
x 63mm (H)

EXS PTO



Classic Cornice Quadrant
84mm (L) x 84mm (W)
x 63mm (H)

EXS PTO

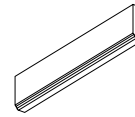

Tangent Light Pelmet
18mm (W) x 57mm (H)
3050mm Lengths

EXS PTO

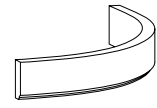

Curved Tangent Pelmet
300mm (L) x 300mm (W)
x 57mm (H)

EXS PTO

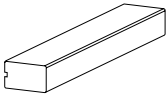

Modern Cornice / Pelmet
50mm (W) x 30mm (H)
3050mm Lengths

EXS PTO

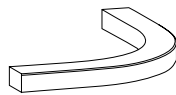

Curved Modern Cornice Pelmet
350mm (L) x 350mm (W)
x 30mm (H)

EXS PTO

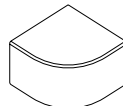

Modern Cornice / Pelmet Quadrant
50mm (L) x 50mm (W)
x 30mm (H)

EXS PTO

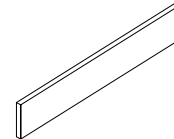

Plain Plinth
18mm (W) x 150mm (H)
2850mm Lengths

EXS PTO



Curved Plain Plinth
540mm (L) x 232mm (W)
x 150mm (H)

EXS PTO

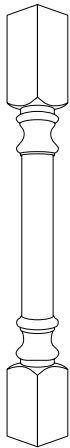

Turned Pilaster
30mm (L) x 30mm (W)
x 720mm (H)

EXS PTO



Corner Post
30mm (L) x 30mm (W)
x 720mm (H)

EXS PTO

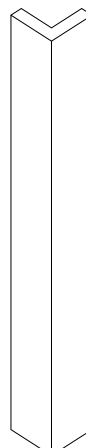

MTM Corner Post
715mm (150 x 150mm Max)

MTM

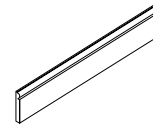

Torus Plinth
18mm (W) x 150mm (H)
3050mm Lengths

EXS PTO

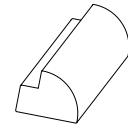

Radius Profile
(R 48mm) 70mm (W) x 50mm (H)
3050mm Lengths

EXS PTO

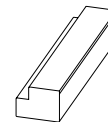

Square Base Pilaster
965mm (L) x 70mm (W)
x 50mm (H)

EXS PTO

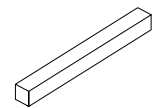

Square Base Pilaster Insert
965mm (L) x 19mm (W)
x 19mm (H)

EXS PTO

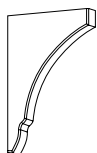

Shelf Bracket
100mm (L) x 18mm (W)
x 150mm (H)

EXS PTO

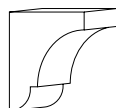

Corbel
125mm (L) x 90mm (W)
x 165mm (H)

EXS PTO



French Mantle Corbel
350mm (L) x 90mm (W)
x 600mm (H)

EXS PTO

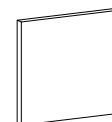

Corbel Back Panel
284mm (W) x 18mm (W)
x 296mm (H)

EXS PTO

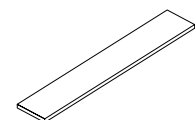

Mantle Shelf
1784mm (L) x 180mm (W)
x 18mm (H)

EXS PTO

Rainey | Accessories

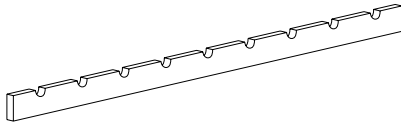

Wine Rack Rail
1200mm (L) x 18mm (W) x 60mm (H)

EXS PTO

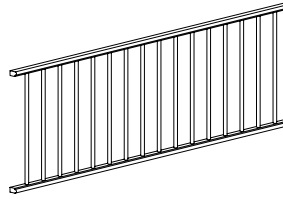
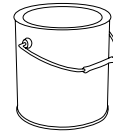
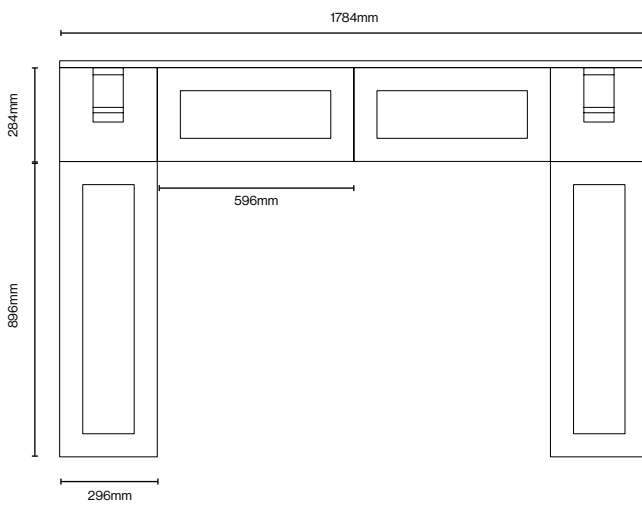

Plate Cot (Pair)
1000mm (L) x 23mm (W) x 308mm (H)

EXS PTO



Touch Up Paint
Available 30ml or 1Litre volumes.



Rainey Overmantle Kit
Includes: 2 x Classic Corbels / 2 x Corbel back Panels / 2 x Doors 896 x 296mm / 2 x Drawers 284 x 596mm / 1 x Mantle Shelf

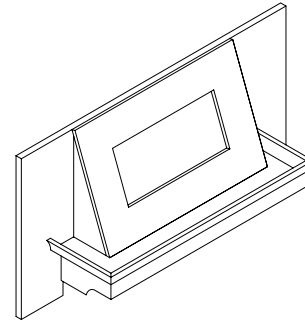

Modern Canopy
1000mm (W) x 228mm (D) x 525mm (H)

EXS PTO

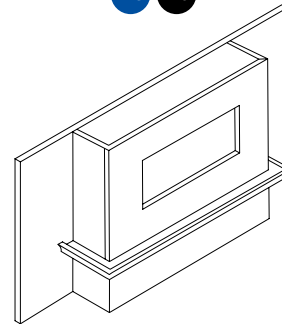

Classic Canopy
1000mm (W) x 215mm (D) x 485mm (H)

MTM

Panel	Size MM	Primed Ex.Stock	Painted To Order	Unfinished MTM*	Painted MTM
Plain / T&G Panel	18mm / 785 x 360mm	●	●	●	●
Plain / T&G Panel	18mm / 900 x 360mm	●	●	●	●
Plain / T&G Panel	18mm / 900x 650mm	●	●	●	●
Plain / T&G Panel	18mm / 900 x 864mm	●	●	●	●
Plain / T&G Panel	18mm / 900 x 1160mm	●	●	●	●
Plain / T&G Panel	18mm / 900 x 1200mm	●	●	●	●
Plain / T&G Panel	18mm / 965 x 360mm	●	●	●	●
Plain / T&G Panel	18mm / 2400 x 360mm	●	●	●	●
Plain / T&G Panel	18mm / 2400x 650mm	●	●	●	●
Plain / T&G Panel	18mm / 2400x 900mm	●	●	●	●
Plain / T&G Panel	Made to Measure per m2	×	●	●	●

*Unfinished MTM - These items will be supplied as unfinished MDF.



Plain Panel / 18mm Thick

EXS PTO MTM

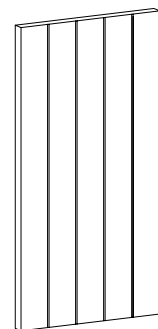

T&G Panel / 18mm Thick

EXS PTO MTM

Edison | Solid Timber Matt Painted Door

Solid Timber Painted | Ex.Stock and MTM



Door Specification

Description	Beaded Shaker Door with 84mm Stiles
Finish	Matt Painted Finish
Door Thickness	20mm Thick
Base Material	Solid Ash Core with Veneered Centre Panel



Available
Primed Ex.Stock



32 Painted
Colours



Available
Painted to Order
standard sizes.



Available
Made to Measure



Solid Ash
Timber



Edison Door

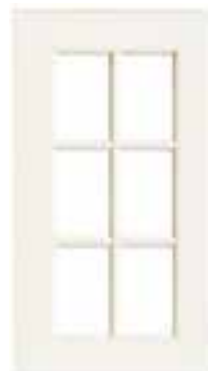

Edison Georgian Frame



Edison Curved Door



Edison Pan Drawer

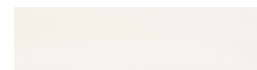

Edison Drawer

Edison | Colours / Finishes

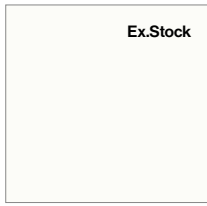

Primed

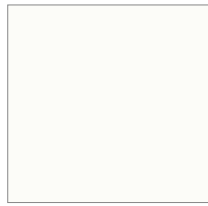

White



Taupe

Colours swatches shown are approximate.

See Painted Swatch Book for true colour match.

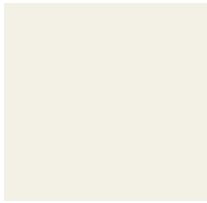

Porcelano



Highland Grey

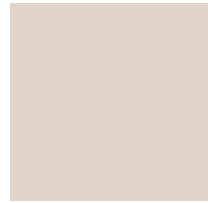

Cashmere



Sea Breeze



Light Blue

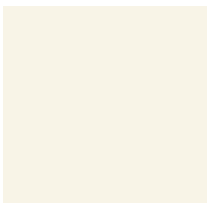

Ivory



Light Grey



French Chalk



Sage



Denim

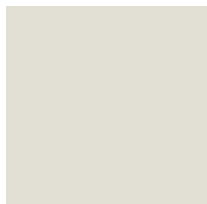

Mussel

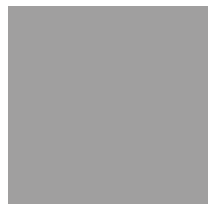

Dust Grey



Heritage Pink



Liberty Green



Eiffel Blue

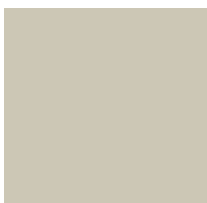

Dakar



Pebble

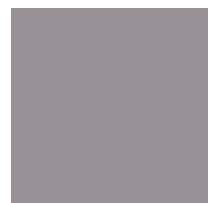

French Lavender



Moss Green



Nautical

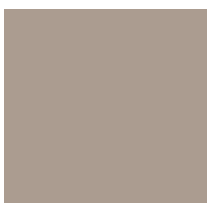

Stone Grey

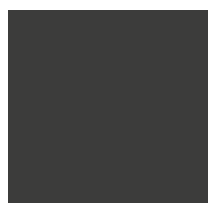

Graphite

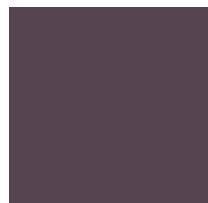

Foraged Fruit



Heritage Green



Marine Blue



Honeycomb



Carbon Black



Heritage Red

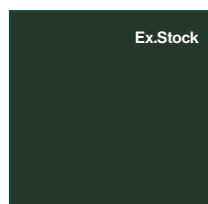

Conifer

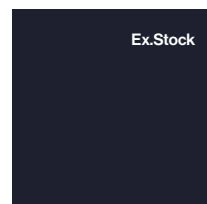

Indigo

Edison | Door and Drawer Sizes

Solid Timber Painted | Ex.Stock and MTM



Kitchen Door Sizes			
Doors Sizes	EXS	PTO	MTM
115 x 596			
140 x 296			
140 x 396			
140 x 446			
140 x 496			
140 x 596			
140 x 796			
140 x 896			
140 x 996			
176 x 396			
176 x 496			
176 x 596			
284 x 496			
284 x 596			
284 x 796			
284 x 896			
284 x 996			
356 x 496			
356 x 596			
356 x 796			
356 x 896			
356 x 996			
450 x 596			
496 x 396			
496 x 596			
570 x 296			

Curved Door sizes			
	EXS	PTO	
716 x 300			
896 x 300			

Plain Frame Sizes		MTM
716 x 396 (Unglazed)		
716 x 496 (Unglazed)		
896 x 496 (Unglazed)		
1060 x 496 (Unglazed)		

Georgian Frame Sizes		EXS	PTO
716 x 396 (Glazed)			
716 x 496 (Glazed)			
896 x 496 (Glazed)			
1060 x 496 (Glazed)			

Handleless Rail System / Door Sizes			
Kitchen Door Sizes			MTM
160 x 296	325 x 596	685 x 146	
160 x 396	325 x 796	685 x 296	
160 x 446	325 x 896	685 x 315	
160 x 496	325 x 996	685 x 346	
160 x 596	490 x 296	685 x 396	
160 x 796	490 x 396	685 x 446	
160 x 896	490 x 446	685 x 496	
160 x 996	490 x 496	685 x 596	
325 x 496	490 x 596		

Drilling - Additional charge per hole.

Non-Standard Kitchen Door Sizes - Priced as MTM
Angled Doors are not available.

Primed MTM Sizes are not available.
MTM timber doors cannot be cancelled once ordered.
MTM Timber doors are non-returnable.

Non-Standard Curved Door Sizes are not available.
Concave Doors are not available.

Standard Georgian Frame Sizes - Supplied Glazed.
Non Standard Georgian Frame Sizes are not available.
Non Standard Plain Frame Sizes - Supplied Unglazed.
Non Standard Plain Frame Sizes - Priced as door size plus 35%.
Non Standard Top Open Feature Frame Sizes - Priced as door size plus 35%.

Drilling - Additional charge per hole.

Edison | Technical Specification

Solid Timber Doors:

Door sizes between 283mm - 1245mm high are supplied as single panels as standard. Maximum Door Width is 996mm. Minimum Door Width is 246mm.

Stile width will be reduced as necessary for Doors sized below 296mm wide.

Angled doors are not available.

Solid Timber Drawers:

Drawer sizes between 50mm - 200mm high are supplied as flat panels as standard. Maximum Drawer width is 1196mm. Minimum Drawer width is 100mm.

Pan Drawer sizes between 283mm - 400mm high are supplied as single panels as standard. Maximum Pan Drawer width is 1196mm. Minimum Pan Drawer width is 246mm.

Stile width will be reduced as necessary for Pan Drawers sized below 296mm wide.

Please note it's important to specify either Door, Drawer or Pan Drawer when ordering to ensure your order is processed correctly.

Solid Timber Frames:

Plain Frame sizes between 283mm - 1245mm high are supplied as single panels as standard. Maximum Plain Frame width is 996mm. Minimum Plain Frame width is 246mm.

Stile width will be reduced as necessary for Plain Frames sized below 296mm wide.

Standard Kitchen Frame sizes are supplied glazed. Non Standard Kitchen and Bedroom Frame sizes are supplied unglazed. Unglazed frames are rebated on the reverse side and supplied with a glazing gasket.

MTM Georgian Frames not available. Angled Frames are not available.

Solid Timber Curved Doors:

Solid Timber Curved doors are made to suit 300 x 300mm cabinets only. Solid Timber Curved Doors are available in standard listed sizes only.

MTM Solid Timber Doors are not available. Concave doors are not available.

Drilling:

All door styles are supplied un-drilled unless requested by the customer. If drilling is required, drilling instructions must clearly state full dimensions for all holes required.

Edison Door Cross Section

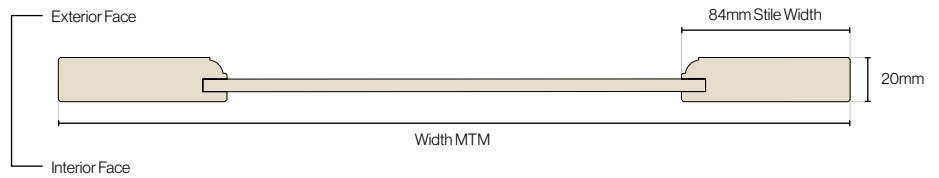

Edison Stile Cross Section

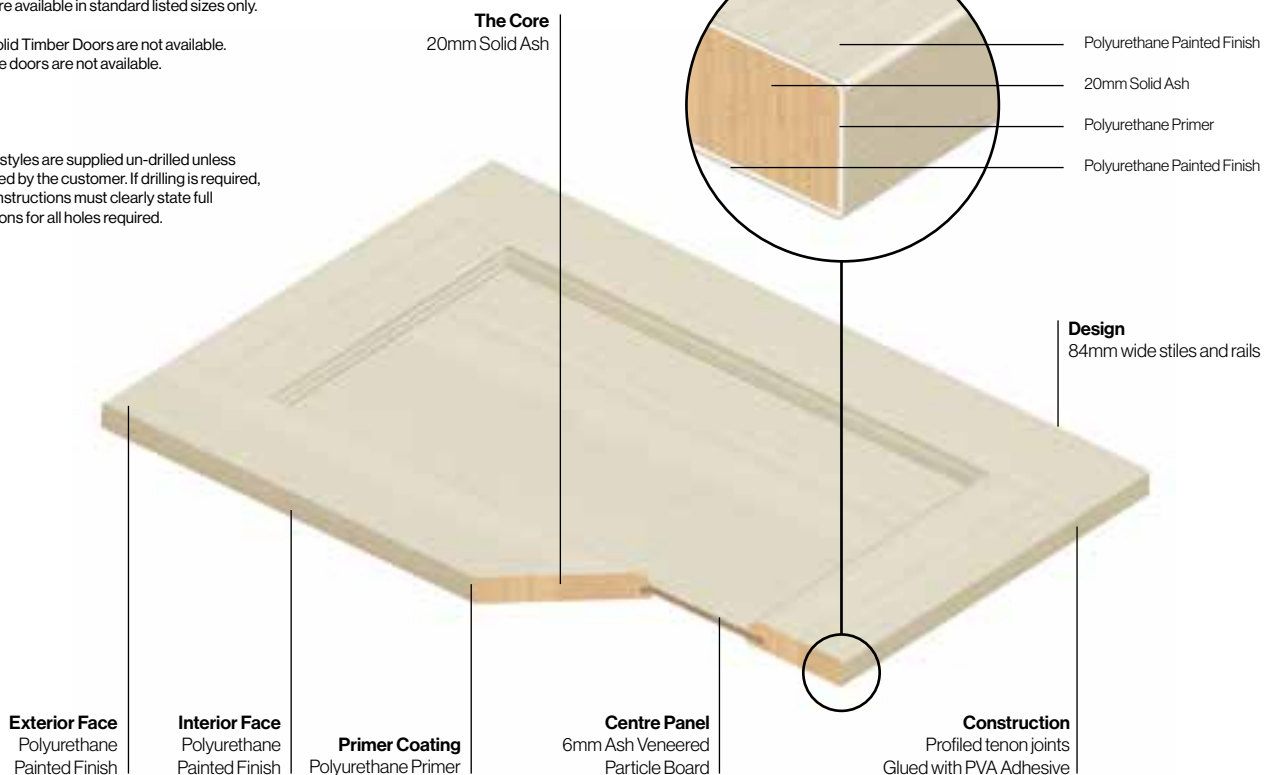
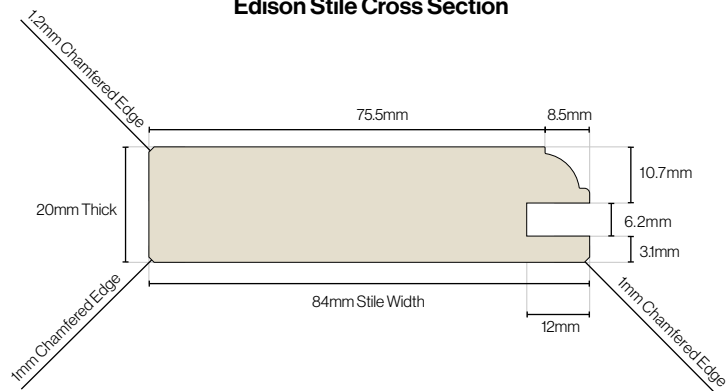

Edison | Accessories

Solid Timber Painted | Ex:Stock and MTM

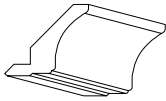

Classic Cornice (Grained)
76mm (W) x 63mm (H)
3050mm Lengths

EXS PTO

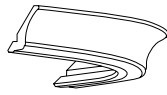

Curved Classic Cornice
364mm (L) x 364mm (W)
x 63mm (H)

EXS PTO



Classic Cornice Quadrant
84mm (L) x 84mm (W)
x 63mm (H)

EXS PTO

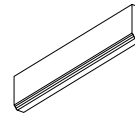

Tangent Light Pelmet
18mm (W) x 57mm (H)
3050mm Lengths

EXS PTO

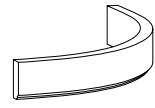

Curved Tangent Pelmet
300mm (L) x 300mm (W)
x 57mm (H)

EXS PTO

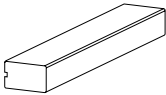

Modern Cornice / Pelmet
50mm (W) x 30mm (H)
3050mm Lengths

EXS PTO

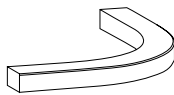

Curved Modern Cornice Pelmet
350mm (L) x 350mm (W)
x 30mm (H)

EXS PTO

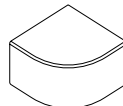

Modern Cornice / Pelmet Quadrant
50mm (L) x 50mm (W)
x 30mm (H)

EXS PTO

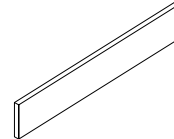

Plain Plinth
18mm (W) x 150mm (H)
2850mm Lengths

EXS PTO

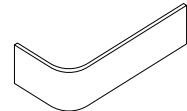

Curved Plain Plinth
540mm (L) x 232mm (W)
x 150mm (H)

EXS PTO

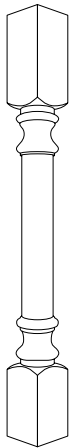

Turned Pilaster
30mm (L) x 30mm (W)
x 720mm (H)

EXS PTO



Corner Post
30mm (L) x 30mm (W)
x 720mm (H)

EXS PTO

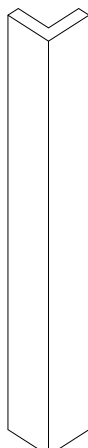

MTM Corner Post
715mm (150 x 150mm Max)

MTM

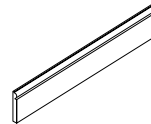

Torus Plinth
18mm (W) x 150mm (H)
3050mm Lengths

EXS PTO

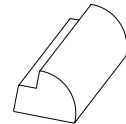

Radius Profile
(R 48mm) 70mm (W) x 50mm (H)
3050mm Lengths

EXS PTO

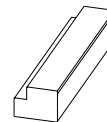

Square Base Pilaster
965mm (L) x 70mm (W)
x 50mm (H)

EXS PTO

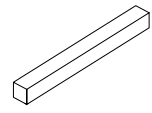

Square Base Pilaster Insert
965mm (L) x 19mm (W)
x 19mm (H)

EXS PTO

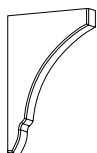

Shelf Bracket
100mm (L) x 18mm (W)
x 150mm (H)

EXS PTO

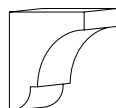

Corbel
125mm (L) x 90mm (W)
x 165mm (H)

EXS PTO



French Mantle Corbel
350mm (L) x 90mm (W)
x 600mm (H)

EXS PTO

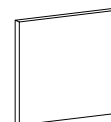

Corbel Back Panel
284mm (W) x 18mm (W)
x 296mm (H)

EXS PTO

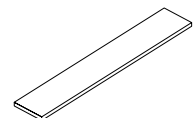

Mantle Shelf
1784mm (L) x 180mm (W)
x 18mm (H)

EXS PTO

Edison | Accessories

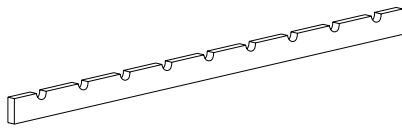

Wine Rack Rail
1200mm (L) x 18mm (W) x 60mm (H)

EXS PTO

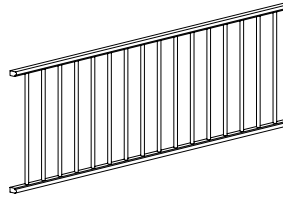
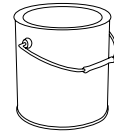

Plate Cot (Pair)
1000mm (L) x 23mm (W) x 308mm (H)

EXS PTO



Touch Up Paint
Available 30ml or 1Litre volumes.

Solid Timber Painted | Ex.Stock and MTM

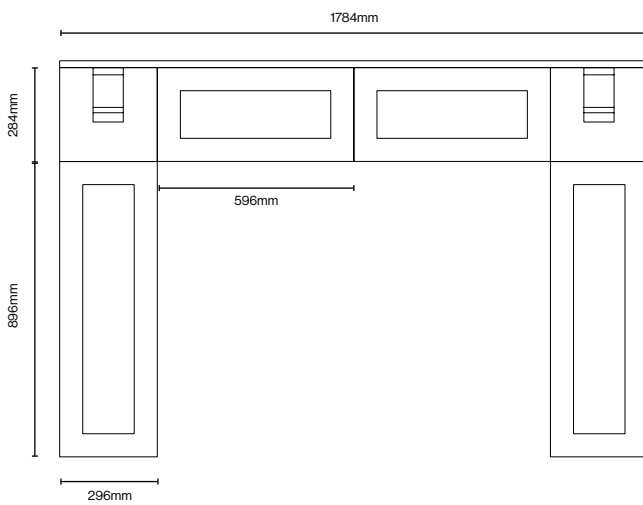

Edison Overmantle Kit

Includes: 2 x Classic Corbels / 2 x Corbel back Panels / 2 x Doors 896 x 296mm / 2 x Drawers 284 x 596mm / 1 x Mantle Shelf

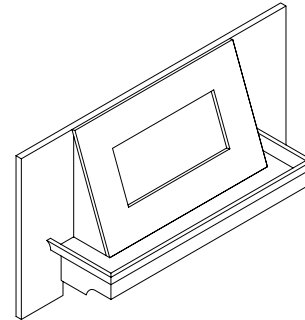

Modern Canopy
1000mm (W) x 228mm (D) x 525mm (H)

EXS PTO

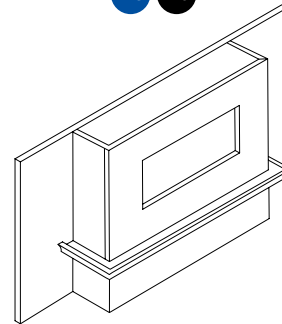

Classic Canopy
1000mm (W) x 215mm (D) x 485mm (H)

MTM

Panel	Size MM	Primed Ex.Stock	Painted To Order	Unfinished MTM*	Painted MTM
Plain / T&G Panel	18mm / 785 x 360mm	●	●	●	●
Plain / T&G Panel	18mm / 900 x 360mm	●	●	●	●
Plain / T&G Panel	18mm / 900 x 650mm	●	●	●	●
Plain / T&G Panel	18mm / 900 x 864mm	●	●	●	●
Plain / T&G Panel	18mm / 900 x 1160mm	●	●	●	●
Plain / T&G Panel	18mm / 900 x 1200mm	●	●	●	●
Plain / T&G Panel	18mm / 965 x 360mm	●	●	●	●
Plain / T&G Panel	18mm / 2400 x 360mm	●	●	●	●
Plain / T&G Panel	18mm / 2400 x 650mm	●	●	●	●
Plain / T&G Panel	18mm / 2400 x 900mm	●	●	●	●
Plain / T&G Panel	Made to Measure per m2	×	●	●	●

*Unfinished MTM - These items will be supplied as unfinished MDF.



Plain Panel / 18mm Thick

EXS PTO MTM

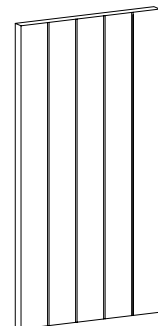

T&G Panel / 18mm Thick

EXS PTO MTM

EXS Available Primed Ex.Stock. Ready for 48h despatch.

PTO Available Painted to Order standard sizes.

MTM Available Made to Measure Unfinished / Painted.

Monroe | Solid Timber Matt Painted Door

Solid Timber Painted | Ex.Stock and MTM



Door Specification

Description	Plain Shaker Door with 75mm Stiles
Finish	Matt Painted Finish
Door Thickness	20mm Thick
Base Material	Solid Ash Core with Veneered Centre Panel
Edge	1mm Bevelled Edge.



Available
Primed Ex.Stock



32 Painted
Colours



Available
Painted to Order
standard sizes.



Available
Made to Measure



Solid Ash
Timber



Monroe Door



Monroe Frame



Monroe Curved Door



Monroe Pan Drawer

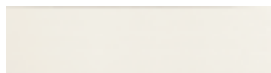

Monroe Drawer

Monroe | Colours / Finishes

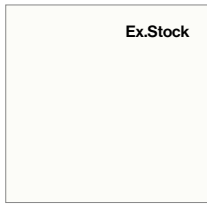

Primed

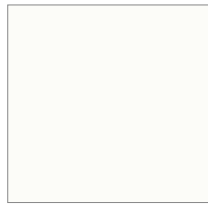

White



Taupe

Colours swatches shown are approximate.

See Painted Swatch Book for true colour match.

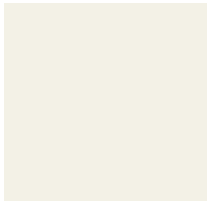

Porcelano



Highland Grey

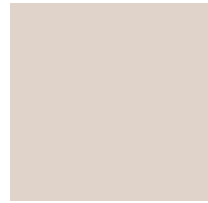

Cashmere



Sea Breeze



Light Blue

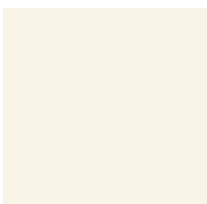

Ivory



Light Grey

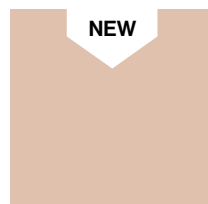

French Chalk



Sage



Denim

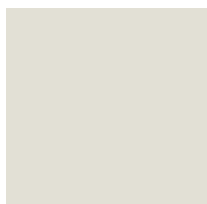

Mussel

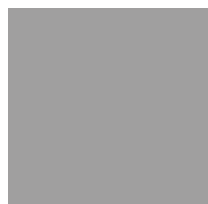

Dust Grey



Heritage Pink



Liberty Green



Eiffel Blue

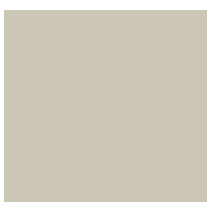

Dakar

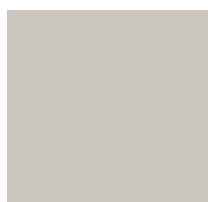

Pebble

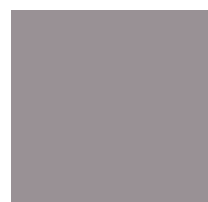

French Lavender



Moss Green



Nautical



Stone Grey

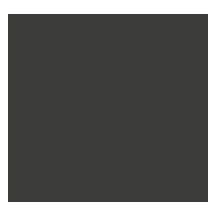

Graphite

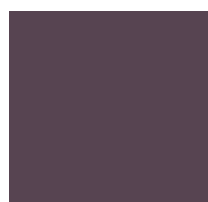

Foraged Fruit



Heritage Green



Marine Blue



Honeycomb



Carbon Black



Heritage Red



Conifer

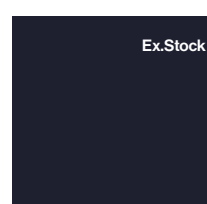

Indigo

Monroe | Door and Drawer Sizes

Solid Timber Painted | Ex,Stock and MTM



Kitchen Door Sizes			
Doors Sizes		Curved Door sizes	
115 x 596	570 x 396	716 x 300	
140 x 296	570 x 446	896 x 300	
140 x 396	570 x 496		
140 x 446	570 x 596		
140 x 496	645 x 596		
140 x 596	716 x 146		
140 x 796	716 x 256		
140 x 896	716 x 275		
140 x 996	716 x 296		
176 x 396	716 x 315		
176 x 496	716 x 346		
176 x 596	716 x 396		
284 x 496	716 x 446		
284 x 596	716 x 496		
284 x 796	716 x 546		
284 x 896	716 x 596		
284 x 996	896 x 296		
356 x 496	896 x 396		
356 x 596	896 x 446		
356 x 796	896 x 496		
356 x 896	896 x 596		
356 x 996	980 x 596		
450 x 596	1245 x 296		
496 x 396	1245 x 396		
496 x 596	1245 x 496		
570 x 296	1245 x 596		

Handleless Rail System / Door Sizes			
Kitchen Door Sizes			MTM
160 x 296	325 x 596	685 x 146	
160 x 396	325 x 796	685 x 296	
160 x 446	325 x 896	685 x 315	
160 x 496	325 x 996	685 x 346	
160 x 596	490 x 296	685 x 396	
160 x 796	490 x 396	685 x 446	
160 x 896	490 x 446	685 x 496	
160 x 996	490 x 496	685 x 596	
325 x 496	490 x 596		

Drilling - Additional charge per hole.

Non-Standard Kitchen Door Sizes - Priced as MTM
Angled Doors are not available.

Primed MTM Sizes are not available.
MTM timber doors cannot be cancelled once ordered.
MTM Timber doors are non-returnable.

Non-Standard Curved Door Sizes are not available.
Concave Doors are not available.

Standard Plain Frame Sizes - Supplied Glazed.
Non Standard Plain Frame Sizes - Supplied Unglazed.
Non Standard Plain Frame Sizes - Priced as door size plus 35%.
Non Standard Top Open Feature Frame Sizes - Priced as door size plus 35%.
Georgian Frame Sizes are not available.

Drilling - Additional charge per hole.

Monroe | Technical Specification

Solid Timber Doors:

Door sizes between 283mm - 1245mm high are supplied as single panels as standard. Maximum Door Width is 996mm. Minimum Door Width is 246mm.

Stile width will be reduced as necessary for Doors sized below 296mm wide.

Angled doors are not available.

Solid Timber Drawers:

Drawer sizes between 50mm - 200mm high are supplied as flat panels as standard. Maximum Drawer width is 1196mm. Minimum Drawer width is 100mm.

Pan Drawer sizes between 283mm - 400mm high are supplied as single panels as standard. Maximum Pan Drawer width is 1196mm. Minimum Pan Drawer width is 246mm.

Stile width will be reduced as necessary for Pan Drawers sized below 296mm wide.

Please note it's important to specify either Door, Drawer or Pan Drawer when ordering to ensure your order is processed correctly.

Solid Timber Frames:

Plain Frame sizes between 283mm - 1245mm high are supplied as single panels as standard. Maximum Plain Frame width is 996mm. Minimum Plain Frame width is 246mm.

Stile width will be reduced as necessary for Plain Frames sized below 296mm wide.

Standard Kitchen Frame sizes are supplied glazed. Non Standard Kitchen and Bedroom Frame sizes are supplied unglazed. Unglazed frames are rebated on the reverse side and supplied with a glazing gasket.

MTM Georgian Frames not available. Angled Frames are not available.

Solid Timber Curved Doors:

Solid Timber Curved doors are made to suit 300 x 300mm cabinets only. Solid Timber Curved Doors are available in standard listed sizes only.

MTM Solid Timber Doors are not available. Concave doors are not available.

Drilling:

All door styles are supplied un-drilled unless requested by the customer. If drilling is required, drilling instructions must clearly state full dimensions for all holes required.

Monroe Door Cross Section

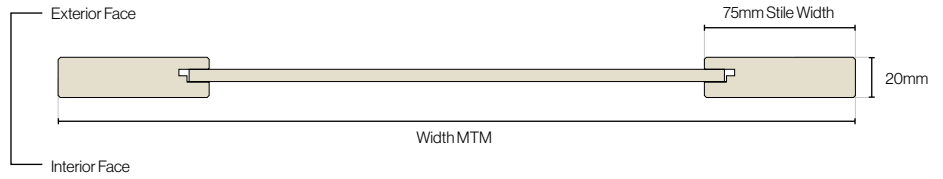

Monroe Stile Cross Section

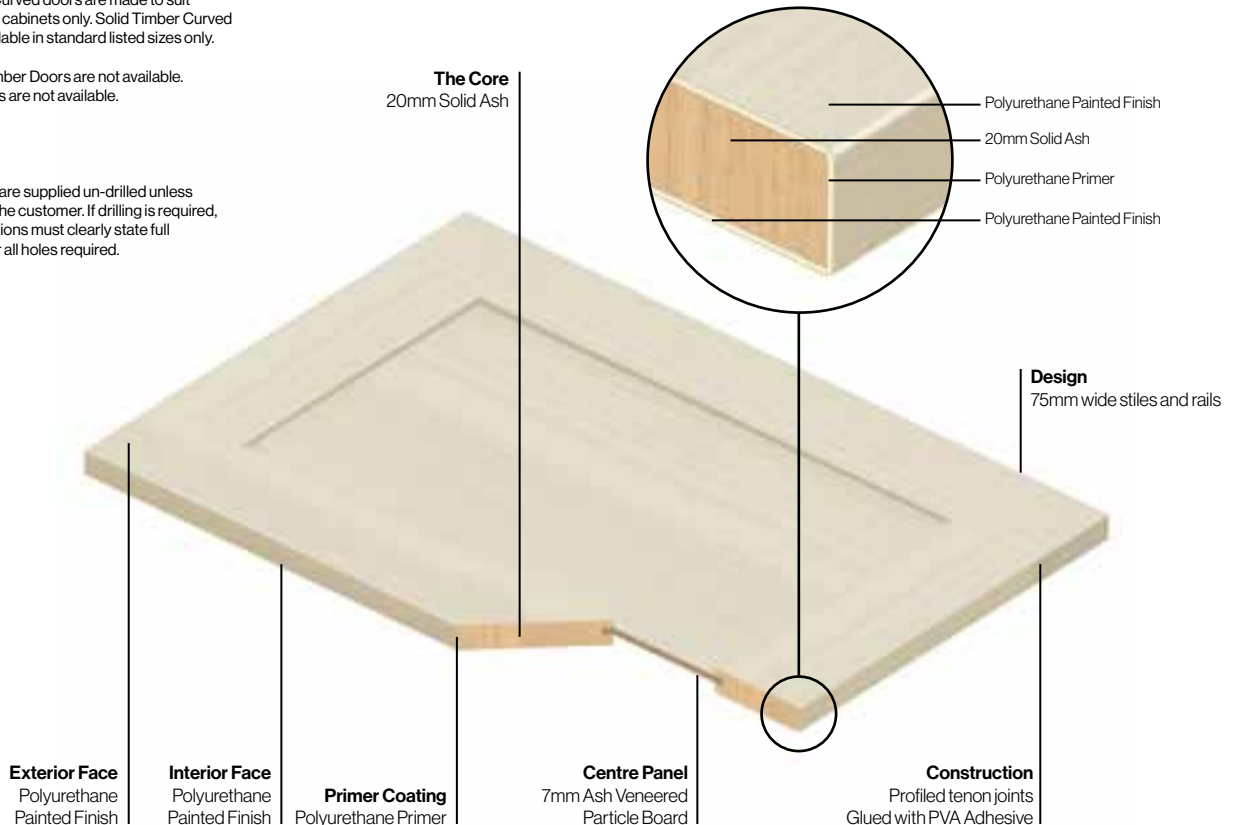
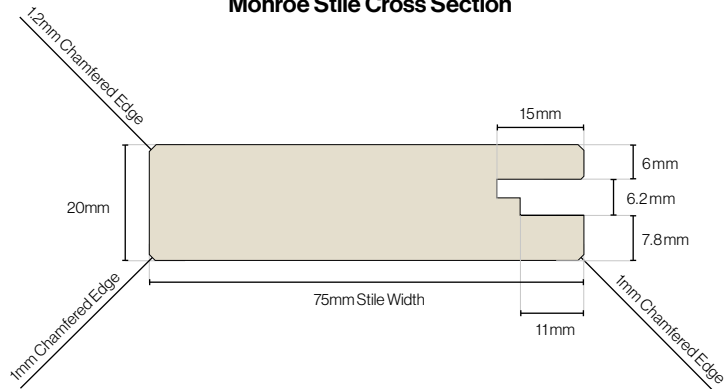

Monroe | Accessories

Solid Timber Painted | Ex:Stock and MTM

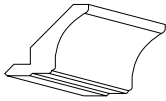

Classic Cornice (Grained)
76mm (W) x 63mm (H)
3050mm Lengths

EXS PTO

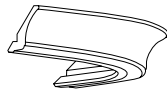

Curved Classic Cornice
364mm (L) x 364mm (W)
x 63mm (H)

EXS PTO

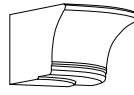

Classic Cornice Quadrant
84mm (L) x 84mm (W)
x 63mm (H)

EXS PTO

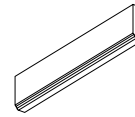

Tangent Light Pelmet
18mm (W) x 57mm (H)
3050mm Lengths

EXS PTO

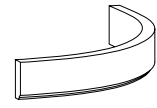

Curved Tangent Pelmet
300mm (L) x 300mm (W)
x 57mm (H)

EXS PTO

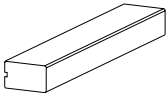

Modern Cornice / Pelmet
50mm (W) x 30mm (H)
3050mm Lengths

EXS PTO

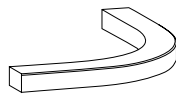

Curved Modern Cornice Pelmet
350mm (L) x 350mm (W)
x 30mm (H)

EXS PTO

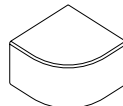

Modern Cornice / Pelmet Quadrant
50mm (L) x 50mm (W)
x 30mm (H)

EXS PTO

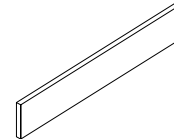

Plain Plinth
18mm (W) x 150mm (H)
2850mm Lengths

EXS PTO



Curved Plain Plinth
540mm (L) x 232mm (W)
x 150mm (H)

EXS PTO

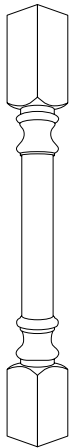

Turned Pilaster
30mm (L) x 30mm (W)
x 720mm (H)

EXS PTO



Corner Post
30mm (L) x 30mm (W)
x 720mm (H)

EXS PTO

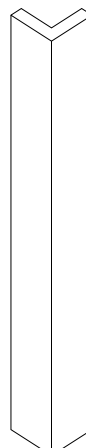

MTM Corner Post
715mm (150 x 150mm Max)

MTM

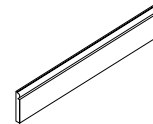

Torus Plinth
18mm (W) x 150mm (H)
3050mm Lengths

EXS PTO



Radius Profile
(R 48mm) 70mm (W) x 50mm (H)
3050mm Lengths

EXS PTO

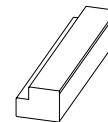

Square Base Pilaster
965mm (L) x 70mm (W)
x 50mm (H)

EXS PTO

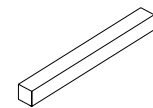

Square Base Pilaster Insert
965mm (L) x 19mm (W)
x 19mm (H)

EXS PTO

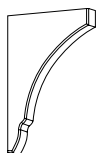

Shelf Bracket
100mm (L) x 18mm (W)
x 150mm (H)

EXS PTO

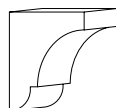

Corbel
125mm (L) x 90mm (W)
x 165mm (H)

EXS PTO



French Mantle Corbel
350mm (L) x 90mm (W)
x 600mm (H)

EXS PTO

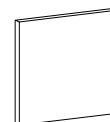

Corbel Back Panel
284mm (W) x 18mm (W)
x 296mm (H)

EXS PTO

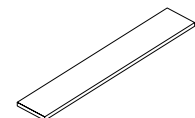

Mantle Shelf
1784mm (L) x 180mm (W)
x 18mm (H)

EXS PTO

Monroe | Accessories

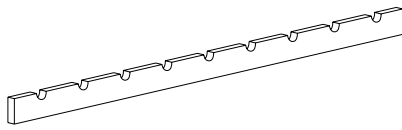

Wine Rack Rail
1200mm (L) x 18mm (W) x 60mm (H)

EXS PTO

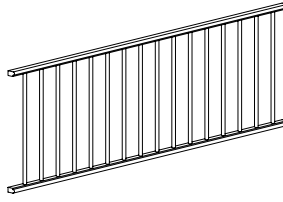

Plate Cot (Pair)
1000mm (L) x 23mm (W) x 308mm (H)

EXS PTO



Touch Up Paint
Available 30ml or 1Litre volumes.

Solid Timber Painted | Ex.Stock and MTM

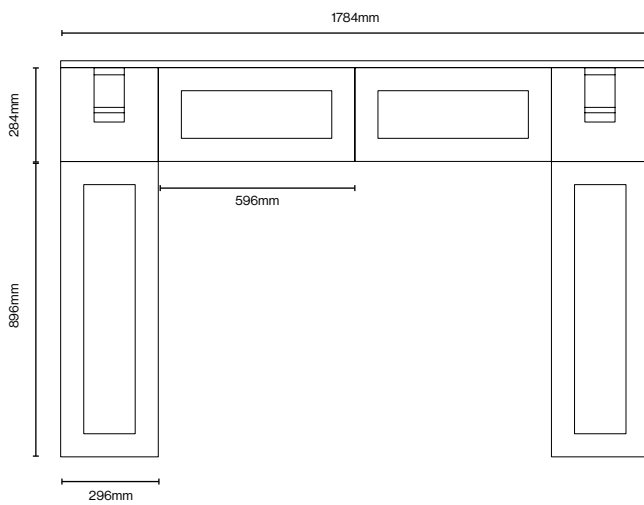

Monroe Overmantle Kit
Includes: 2 x Classic Corbels / 2 x Corbel back Panels / 2 x Doors 896 x 296mm / 2 x Drawers 284 x 596mm / 1 x Mantle Shelf

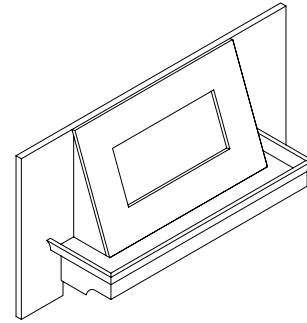

Modern Canopy
1000mm (W) x 228mm (D) x 525mm (H)

EXS PTO

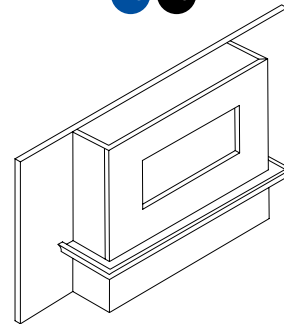

Classic Canopy
1000mm (W) x 215mm (D) x 485mm (H)

MTM

Panel	Size MM	Primed Ex.Stock	Painted To Order	Unfinished MTM*	Painted MTM
Plain / T&G Panel	18mm / 785 x 360mm	●	●	●	●
Plain / T&G Panel	18mm / 900 x 360mm	●	●	●	●
Plain / T&G Panel	18mm / 900 x 650mm	●	●	●	●
Plain / T&G Panel	18mm / 900 x 864mm	●	●	●	●
Plain / T&G Panel	18mm / 900 x 1160mm	●	●	●	●
Plain / T&G Panel	18mm / 900 x 1200mm	●	●	●	●
Plain / T&G Panel	18mm / 965 x 360mm	●	●	●	●
Plain / T&G Panel	18mm / 2400 x 360mm	●	●	●	●
Plain / T&G Panel	18mm / 2400 x 650mm	●	●	●	●
Plain / T&G Panel	18mm / 2400 x 900mm	●	●	●	●
Plain / T&G Panel	Made to Measure per m2	×	●	●	●

*Unfinished MTM - These items will be supplied as unfinished MDF.



Plain Panel / 18mm Thick

EXS PTO MTM

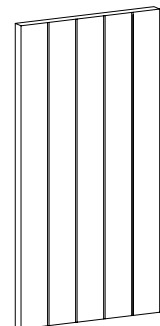

T&G Panel / 18mm Thick

EXS PTO MTM

EXS Available Primed Ex.Stock. Ready for 48h despatch.

PTO Available Painted to Order standard sizes.

MTM Available Made to Measure Unfinished / Painted.

Albany | Solid Timber Matt Painted Door

Solid Timber Painted | Ex.Stock and MTM



Door Specification

Description	Lined Shaker Door with 105mm Stiles
Finish	Matt Painted Finish
Door Thickness	20mm Thick
Base Material	Solid Ash Core with Veneered Centre Panel
Edge	1mm Bevelled Edge.



**Available
Primed Ex.Stock**



**32 Painted
Colours**



**Available
Painted to Order
standard sizes.**



**Available
Made to Measure**



**Solid Ash
Timber**



Albany Door



Albany Frame



Albany Curved Door

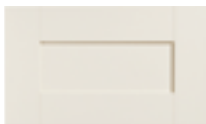

Albany Pan Drawer

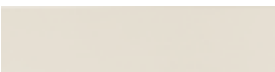

Albany Drawer

Albany | Kitchen Door Sizes



Primed



White

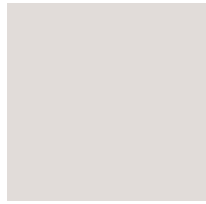

Taupe

Colours swatches shown are approximate.

See Painted Swatch Book for true colour match.

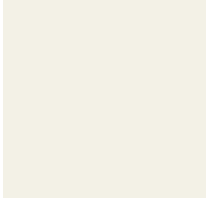

Porcelano

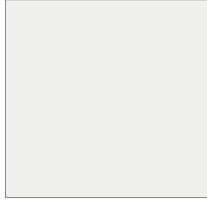

Highland Grey

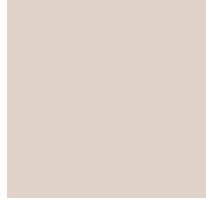

Cashmere



Sea Breeze

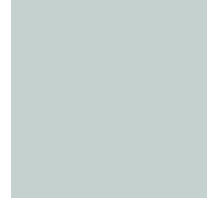

Light Blue

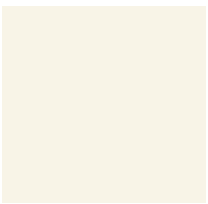

Ivory

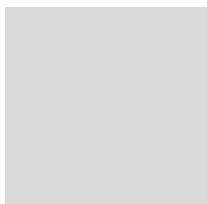

Light Grey



French Chalk



Sage



Denim

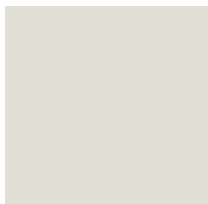

Mussel

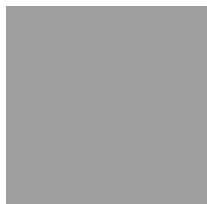

Dust Grey



Heritage Pink



Liberty Green



Eiffel Blue



Dakar

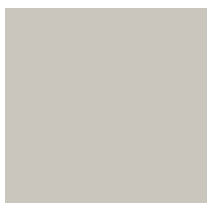

Pebble

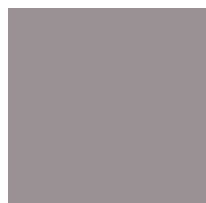

French Lavender



Moss Green



Nautical

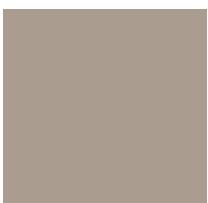

Stone Grey

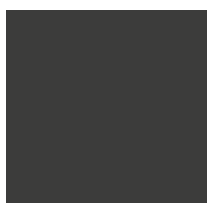

Graphite

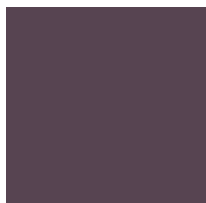

Foraged Fruit



Heritage Green



Marine Blue



Honeycomb



Carbon Black



Heritage Red

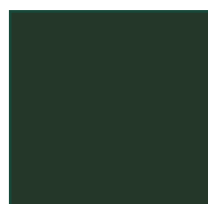

Conifer



Indigo

Albany | Door and Drawer Sizes

Solid Timber Painted | Ex.Stock and MTM



Kitchen Door Sizes						
Doors Sizes	EXS	PTO	MTM	Curved Door sizes	EXS	PTO
115 x 596				716 x 300		
140 x 296				896 x 300		
140 x 396						
140 x 446						
140 x 496						
140 x 596						
140 x 596						
140 x 796						
140 x 896						
140 x 996						
176 x 396						
176 x 496						
176 x 596						
284 x 496						
284 x 596						
284 x 796						
284 x 896						
284 x 996						
356 x 496						
356 x 596						
356 x 796						
356 x 896						
356 x 996						
450 x 596						
496 x 396						
496 x 596						
570 x 296						

Plain Frame Sizes			EXS	PTO	MTM
716 x 396 (Glazed)					
716 x 496 (Glazed)					
896 x 496 (Glazed)					
1060 x 496 (Glazed)					

Handleless Rail System / Door Sizes			MTM
Kitchen Door Sizes			MTM
160 x 296	325 x 596	685 x 146	
160 x 396	325 x 796	685 x 296	
160 x 446	325 x 896	685 x 315	
160 x 496	325 x 996	685 x 346	
160 x 596	490 x 296	685 x 396	
160 x 796	490 x 396	685 x 446	
160 x 896	490 x 446	685 x 496	
160 x 996	490 x 496	685 x 596	
325 x 496	490 x 596		

Drilling - Additional charge per hole.

Non-Standard Kitchen Door Sizes - Priced as MTM
Angled Doors are not available.

Primed MTM Sizes are not available.
MTM timber doors cannot be cancelled once ordered.
MTM Timber doors are non-returnable.

Non-Standard Curved Door Sizes are not available.
Concave Doors are not available.

Standard Plain Frame Sizes - Supplied Glazed.
Non Standard Plain Frame Sizes - Supplied Unglazed.
Non Standard Plain Frame Sizes - Priced as door size plus 35%.
Non Standard Top Open Feature Frame Sizes - Priced as door size plus 35%.
Georgian Frame Sizes are not available.

Drilling - Additional charge per hole.

Albany | Technical Specifications

Solid Timber Doors:

Door sizes between 283mm - 1245mm high are supplied as single panels as standard. Maximum Door Width is 996mm. Minimum Door Width is 246mm.

Stile width will be reduced as necessary for Doors sized below 296mm wide.

Angled doors are not available.

Solid Timber Drawers:

Drawer sizes between 50mm - 200mm high are supplied as flat panels as standard. Maximum Drawer width is 1196mm. Minimum Drawer width is 100mm.

Pan Drawer sizes between 283mm - 400mm high are supplied as single panels as standard. Maximum Pan Drawer width is 1196mm. Minimum Pan Drawer width is 246mm.

Stile width will be reduced as necessary for Pan Drawers sized below 296mm wide.

Please note it's important to specify either Door, Drawer or Pan Drawer when ordering to ensure your order is processed correctly.

Solid Timber Frames:

Plain Frame sizes between 283mm - 1245mm high are supplied as single panels as standard. Maximum Plain Frame width is 996mm. Minimum Plain Frame width is 246mm.

Stile width will be reduced as necessary for Plain Frames sized below 296mm wide.

Standard Kitchen Frame sizes are supplied glazed. Non Standard Kitchen and Bedroom Frame sizes are supplied unglazed. Unglazed frames are rebated on the reverse side and supplied with a glazing gasket.

MTM Georgian Frames not available. Angled Frames are not available.

Solid Timber Curved Doors:

Solid Timber Curved doors are made to suit 300 x 300mm cabinets only. Solid Timber Curved Doors are available in standard listed sizes only.

MTM Solid Timber Doors are not available. Concave doors are not available.

Drilling:

All door styles are supplied un-drilled unless requested by the customer. If drilling is required, drilling instructions must clearly state full dimensions for all holes required.

Albany Door Cross Section

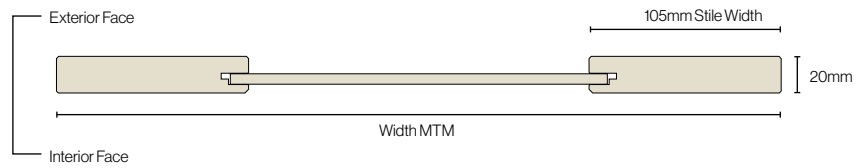

Albany Stile Cross Section



The Core
20mm Solid Ash

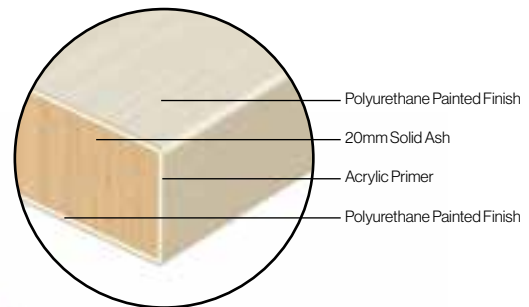

Design
105mm wide stiles and rails

Exterior Face
Polyurethane Painted Finish

Interior Face
Polyurethane Painted Finish

Primer Coating
Polyurethane Primer

Centre Panel
7mm Ash Veneered Particle Board

Construction
Profiled tenon joints
Glued with PVA Adhesive

Albany | Accessories

Solid Timber Painted | Ex:Stock and MTM

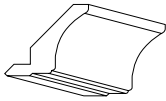

Classic Cornice (Grained)
76mm (W) x 63mm (H)
3050mm Lengths

EXS PTO

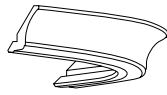

Curved Classic Cornice
364mm (L) x 364mm (W)
x 63mm (H)

EXS PTO

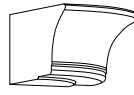

Classic Cornice Quadrant
84mm (L) x 84mm (W)
x 63mm (H)

EXS PTO

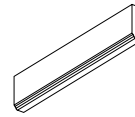

Tangent Light Pelmet
18mm (W) x 57mm (H)
3050mm Lengths

EXS PTO

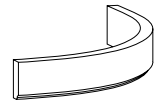

Curved Tangent Pelmet
300mm (L) x 300mm (W)
x 57mm (H)

EXS PTO

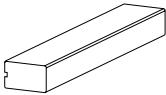

Modern Cornice / Pelmet
50mm (W) x 30mm (H)
3050mm Lengths

EXS PTO

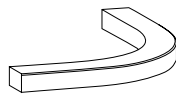

Curved Modern Cornice Pelmet
350mm (L) x 350mm (W)
x 30mm (H)

EXS PTO

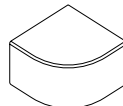

Modern Cornice / Pelmet Quadrant
50mm (L) x 50mm (W)
x 30mm (H)

EXS PTO

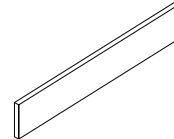

Plain Plinth
18mm (W) x 150mm (H)
2850mm Lengths

EXS PTO



Curved Plain Plinth
540mm (L) x 232mm (W)
x 150mm (H)

EXS PTO

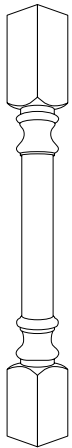

Turned Pilaster
30mm (L) x 30mm (W)
x 720mm (H)

EXS PTO



Corner Post
30mm (L) x 30mm (W)
x 720mm (H)

EXS PTO

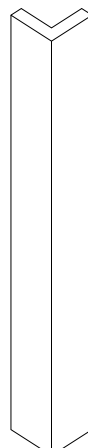

MTM Corner Post
715mm (150 x 150mm Max)

MTM

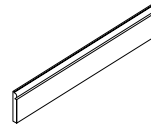

Torus Plinth
18mm (W) x 150mm (H)
3050mm Lengths

EXS PTO



Radius Profile
(R 48mm) 70mm (W) x 50mm (H)
3050mm Lengths

EXS PTO

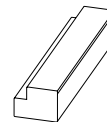

Square Base Pilaster
965mm (L) x 70mm (W)
x 50mm (H)

EXS PTO

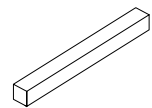

Square Base Pilaster Insert
965mm (L) x 19mm (W)
x 19mm (H)

EXS PTO

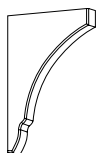

Shelf Bracket
100mm (L) x 18mm (W)
x 150mm (H)

EXS PTO

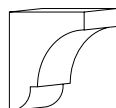

Corbel
125mm (L) x 90mm (W)
x 165mm (H)

EXS PTO



French Mantle Corbel
350mm (L) x 90mm (W)
x 600mm (H)

EXS PTO

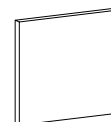

Corbel Back Panel
284mm (W) x 18mm (W)
x 296mm (H)

EXS PTO

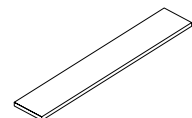

Mantle Shelf
1784mm (L) x 180mm (W)
x 18mm (H)

EXS PTO

Albany | Accessories

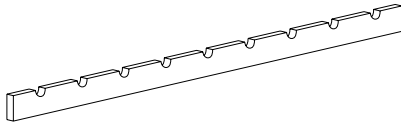

Wine Rack Rail
1200mm (L) x 18mm (W) x 60mm (H)

EXS PTO

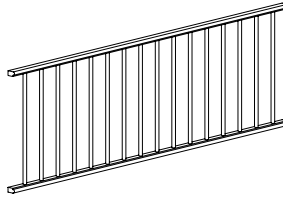

Plate Cot (Pair)
1000mm (L) x 23mm (W) x 308mm (H)

EXS PTO



Touch Up Paint
Available 30ml or 1Litre volumes.

Solid Timber Painted | Ex.Stock and MTM

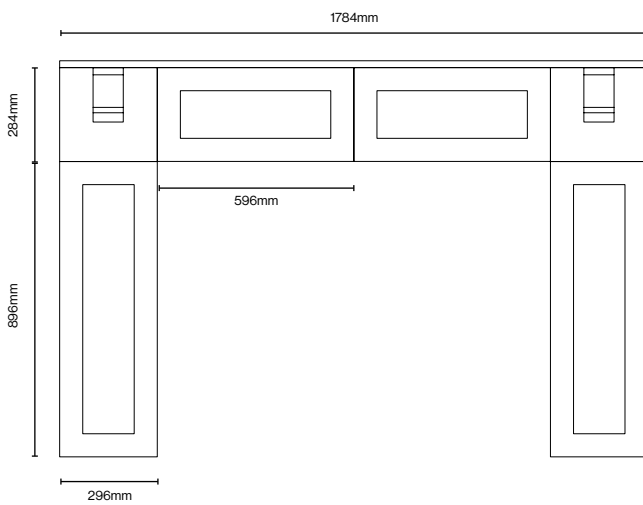

Albany Overmantle Kit

Includes: 2 x Classic Corbels / 2 x Corbel back Panels / 2 x Doors 896 x 296mm / 2 x Drawers 284 x 596mm / 1 x Mantle Shelf

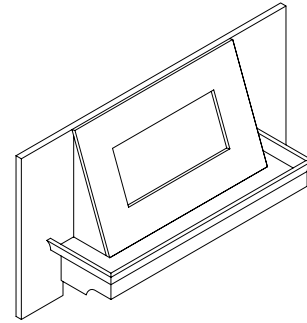

Modern Canopy
1000mm (W) x 228mm (D) x 525mm (H)

EXS PTO

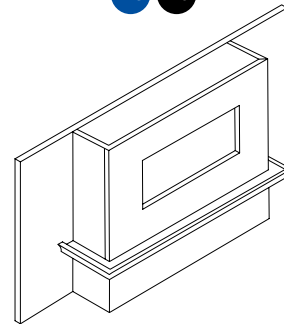

Classic Canopy
1000mm (W) x 215mm (D) x 485mm (H)

MTM

Panel	Size MM	Primed Ex.Stock	Painted To Order	Unfinished MTM*	Painted MTM
Plain / T&G Panel	18mm / 785 x 360mm	●	●	●	●
Plain / T&G Panel	18mm / 900 x 360mm	●	●	●	●
Plain / T&G Panel	18mm / 900x 650mm	●	●	●	●
Plain / T&G Panel	18mm / 900 x 864mm	●	●	●	●
Plain / T&G Panel	18mm / 900 x 1160mm	●	●	●	●
Plain / T&G Panel	18mm / 900 x 1200mm	●	●	●	●
Plain / T&G Panel	18mm / 965 x 360mm	●	●	●	●
Plain / T&G Panel	18mm / 2400 x 360mm	●	●	●	●
Plain / T&G Panel	18mm / 2400x 650mm	●	●	●	●
Plain / T&G Panel	18mm / 2400x 900mm	●	●	●	●
Plain / T&G Panel	Made to Measure per m2	×	●	●	●

*Unfinished MTM - These items will be supplied as unfinished MDF.

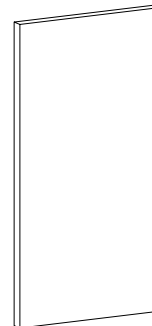

Plain Panel / 18mm Thick

EXS PTO MTM

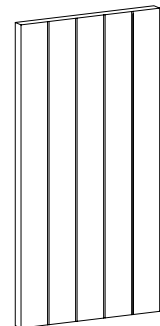

T&G Panel / 18mm Thick

EXS PTO MTM

EXS Available Primed Ex.Stock. Ready for 48h despatch.

PTO Available Painted to Order standard sizes.

MTM Available Made to Measure Unfinished / Painted.





Hampton | Solid Timber Matt Painted Door

Solid Timber Painted | Ex.Stock and MTM



Door Specification

Description	Raised Panel Door with 105mm Stiles
Finish	Matt Painted Finish
Door Thickness	20mm Thick
Base Material	Solid Ash Core with Veneered Centre Panel
Edge	1mm Bevelled Edge.



Hampton Door



Hampton Georgian Frame



Hampton Curved Door

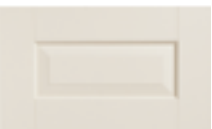

Hampton Pan Drawer

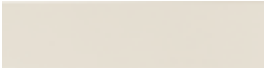

Hampton Drawer

Hampton | Colours / Finishes

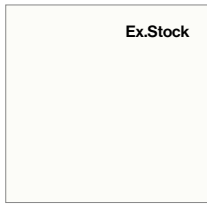

Primed

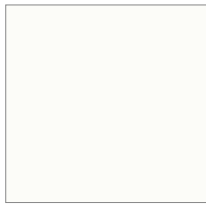

White

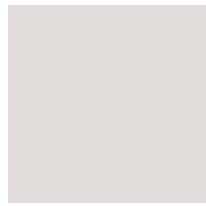

Taupe

Colours swatches shown are approximate.

See Painted Swatch Book for true colour match.

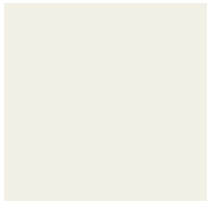

Porcelano



Highland Grey

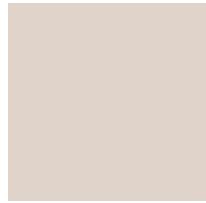

Cashmere



Sea Breeze



Light Blue

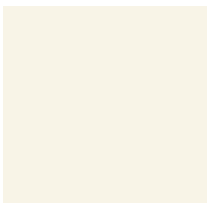

Ivory

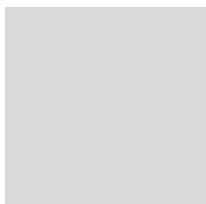

Light Grey



French Chalk



Sage



Denim

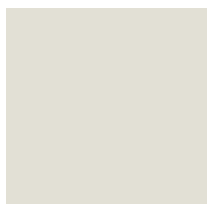

Mussel

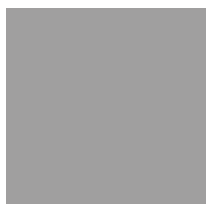

Dust Grey

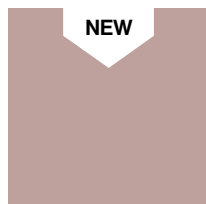

Heritage Pink



Liberty Green



Eiffel Blue

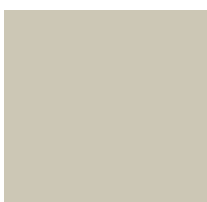

Dakar

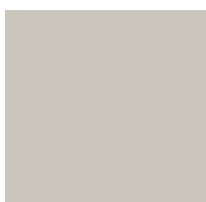

Pebble

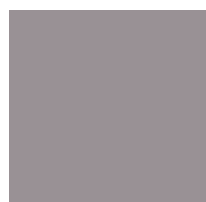

French Lavender



Moss Green



Nautical



Stone Grey



Graphite

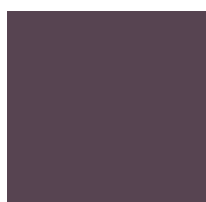

Foraged Fruit



Heritage Green



Marine Blue



Honeycomb



Carbon Black



Heritage Red



Conifer



Indigo

Hampton | Door and Drawer Sizes

Solid Timber Painted | Ex.Stock and MTM



Kitchen Door Sizes						
Doors Sizes	EXS	PTO	MTM	Curved Door sizes	EXS	PTO
115 x 596				716 x 300		
140 x 296				896 x 300		
140 x 396						
140 x 446						
140 x 496						
140 x 596						
140 x 796						
140 x 896						
140 x 996						
176 x 396						
176 x 496						
176 x 596						
284 x 496						
284 x 596						
284 x 796						
284 x 896						
284 x 996						
356 x 496						
356 x 596						
356 x 796						
356 x 896						
356 x 996						
450 x 596						
496 x 396						
496 x 596						
570 x 296						

Handleless Rail System / Door Sizes			
Kitchen Door Sizes			MTM
160 x 296	325 x 596	685 x 146	
160 x 396	325 x 796	685 x 296	
160 x 446	325 x 896	685 x 315	
160 x 496	325 x 996	685 x 346	
160 x 596	490 x 296	685 x 396	
160 x 796	490 x 396	685 x 446	
160 x 896	490 x 446	685 x 496	
160 x 996	490 x 496	685 x 596	
325 x 496	490 x 596		

Drilling - Additional charge per hole.

Non-Standard Kitchen Door Sizes - Priced as MTM
Angled Doors are not available.

Primed MTM Sizes are not available.
MTM timber doors cannot be cancelled once ordered.
MTM Timber doors are non-returnable.

Non-Standard Curved Door Sizes are not available.
Concave Doors are not available.

Standard Frame Sizes - Supplied Glazed.
Non Standard Georgian Frame Sizes are not available.
Non Standard Plain Frame Sizes - Supplied Unglazed.
Non Standard Plain Frame Sizes - Priced as door size plus 35%.
Non Standard Top Open Feature Frame Sizes - Priced as door size plus 35%.

Drilling - Additional charge per hole.



Hampton | Technical Specification

Solid Timber Doors:

Door sizes between 283mm - 1245mm high are supplied as single panels as standard. Maximum Door Width is 996mm. Minimum Door Width is 246mm.

Stile width will be reduced as necessary for Doors sized below 296mm wide.

Angled doors are not available.

Solid Timber Drawers:

Drawer sizes between 50mm - 200mm high are supplied as flat panels as standard. Maximum Drawer width is 1196mm. Minimum Drawer width is 100mm.

Pan Drawer sizes between 283mm - 400mm high are supplied as single panels as standard. Maximum Pan Drawer width is 1196mm. Minimum Pan Drawer width is 246mm.

Stile width will be reduced as necessary for Pan Drawers sized below 296mm wide.

Please note it's important to specify either Door, Drawer or Pan Drawer when ordering to ensure your order is processed correctly.

Solid Timber Frames:

Plain Frame sizes between 283mm - 1245mm high are supplied as single panels as standard. Maximum Plain Frame width is 996mm. Minimum Plain Frame width is 246mm.

Stile width will be reduced as necessary for Plain Frames sized below 296mm wide.

Standard Kitchen Frame sizes are supplied glazed. Non Standard Kitchen and Bedroom Frame sizes are supplied unglazed. Unglazed frames are rebated on the reverse side and supplied with a glazing gasket.

MTM Georgian Frames not available. Angled Frames are not available.

Solid Timber Curved Doors:

Solid Timber Curved doors are made to suit 300 x 300mm cabinets only. Solid Timber Curved Doors are available in standard listed sizes only.

MTM Solid Timber Doors are not available. Concave doors are not available.

Drilling:

All door styles are supplied un-drilled unless requested by the customer. If drilling is required, drilling instructions must clearly state full dimensions for all holes required.

Hampton Door Cross Section

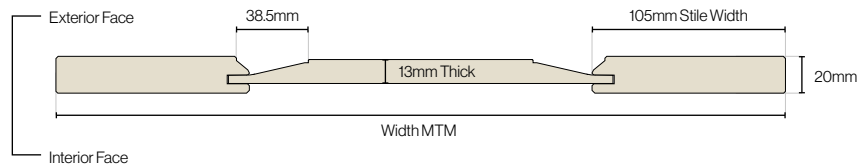

Hampton Stile Cross Section



The Core
20mm Solid Ash

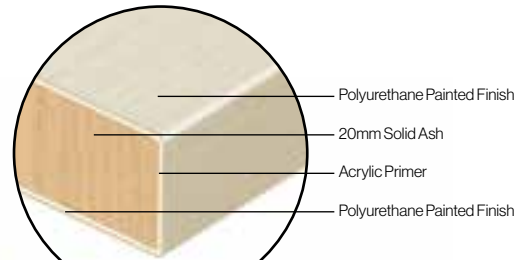

Design
105mm wide stiles and rails

Exterior Face
Polyurethane Painted Finish

Interior Face
Polyurethane Painted Finish

Primer Coating
Polyurethane Primer

Centre Panel
13mm Ash Veneered Particle Board

Construction
Profiled tenon joints
Glued with PVA Adhesive

Hampton | Accessories

Solid Timber Painted | Ex:Stock and MTM

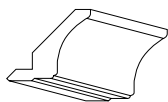

Classic Cornice (Grained)
76mm (W) x 63mm (H)
3050mm Lengths

EXS PTO

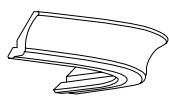

Curved Classic Cornice
364mm (L) x 364mm (W)
x 63mm (H)

EXS PTO



Classic Cornice Quadrant
84mm (L) x 84mm (W)
x 63mm (H)

EXS PTO

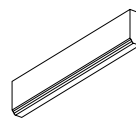

Tangent Light Pelmet
18mm (W) x 57mm (H)
3050mm Lengths

EXS PTO

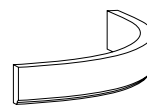

Curved Tangent Pelmet
300mm (L) x 300mm (W)
x 57mm (H)

EXS PTO

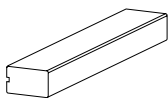

Modern Cornice / Pelmet
50mm (W) x 30mm (H)
3050mm Lengths

EXS PTO

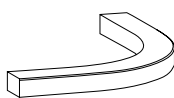

Curved Modern Cornice Pelmet
350mm (L) x 350mm (W)
x 30mm (H)

EXS PTO

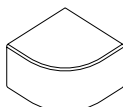

Modern Cornice / Pelmet Quadrant
50mm (L) x 50mm (W)
x 30mm (H)

EXS PTO

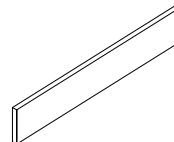

Plain Plinth
18mm (W) x 150mm (H)
2850mm Lengths

EXS PTO



Curved Plain Plinth
540mm (L) x 232mm (W)
x 150mm (H)

EXS PTO

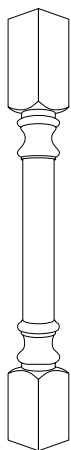

Turned Pilaster
30mm (L) x 30mm (W)
x 720mm (H)

EXS PTO

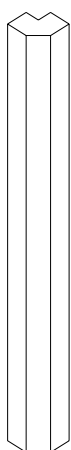

Corner Post
30mm (L) x 30mm (W)
x 720mm (H)

EXS PTO

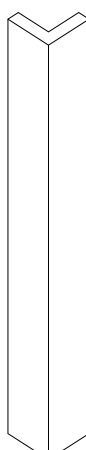

MTM Corner Post
715mm (150 x 150mm Max)

MTM

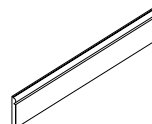

Torus Plinth
18mm (W) x 150mm (H)
3050mm Lengths

EXS PTO



Radius Profile
(R 48mm) 70mm (W) x 50mm (H)
3050mm Lengths

EXS PTO

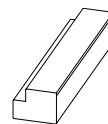

Square Base Pilaster
965mm (L) x 70mm (W)
x 50mm (H)

EXS PTO

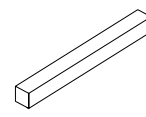

Square Base Pilaster Insert
965mm (L) x 19mm (W)
x 19mm (H)

EXS PTO

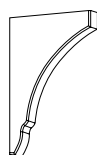

Shelf Bracket
100mm (L) x 18mm (W)
x 150mm (H)

EXS PTO

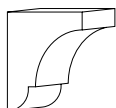

Corbel
125mm (L) x 90mm (W)
x 165mm (H)

EXS PTO

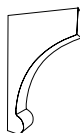

French Mantle Corbel
350mm (L) x 90mm (W)
x 600mm (H)

EXS PTO

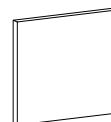

Corbel Back Panel
284mm (W) x 18mm (W)
x 296mm (H)

EXS PTO

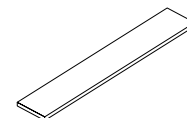

Mantle Shelf
1784mm (L) x 180mm (W)
x 18mm (H)

EXS PTO

Hampton | Accessories

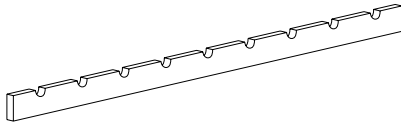

Wine Rack Rail
1200mm (L) x 18mm (W) x 60mm (H)

EXS PTO

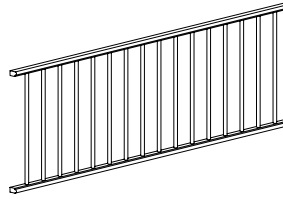
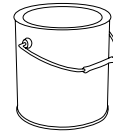

Plate Cot (Pair)
1000mm (L) x 23mm (W) x 308mm (H)

EXS PTO



Touch Up Paint
Available 30ml or 1Litre volumes.

Solid Timber Painted | Ex.Stock and MTM

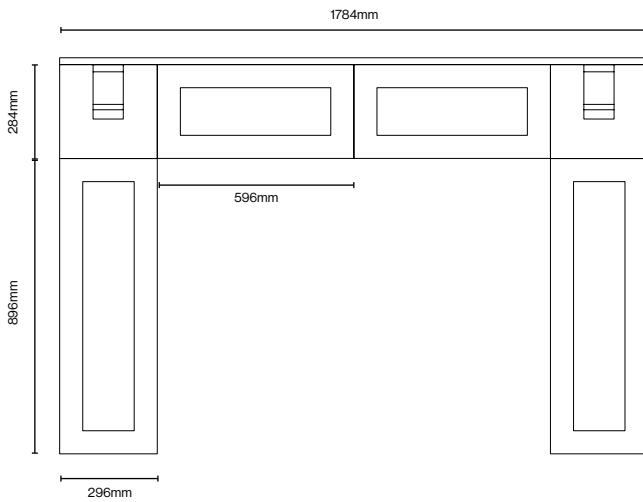

Hampton Overmantle Kit
Includes: 2 x Classic Corbels / 2 x Corbel back Panels / 2 x Doors 896 x 296mm / 2 x Drawers 284 x 596mm / 1 x Mantle Shelf

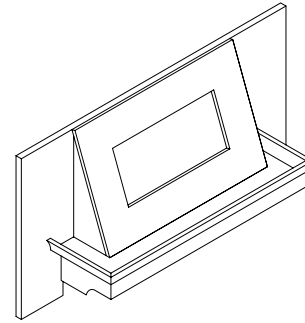

Modern Canopy
1000mm (W) x 228mm (D) x 525mm (H)

EXS PTO

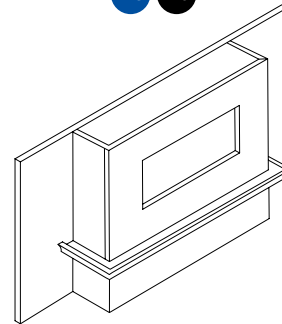

Classic Canopy
1000mm (W) x 215mm (D) x 485mm (H)

MTM

Panel	Size MM	Primed Ex.Stock	Painted To Order	Unfinished MTM*	Painted MTM
Plain / T&G Panel	18mm / 785 x 360mm	●	●	●	●
Plain / T&G Panel	18mm / 900 x 360mm	●	●	●	●
Plain / T&G Panel	18mm / 900 x 650mm	●	●	●	●
Plain / T&G Panel	18mm / 900 x 864mm	●	●	●	●
Plain / T&G Panel	18mm / 900 x 1160mm	●	●	●	●
Plain / T&G Panel	18mm / 900 x 1200mm	●	●	●	●
Plain / T&G Panel	18mm / 965 x 360mm	●	●	●	●
Plain / T&G Panel	18mm / 2400 x 360mm	●	●	●	●
Plain / T&G Panel	18mm / 2400 x 650mm	●	●	●	●
Plain / T&G Panel	18mm / 2400 x 900mm	●	●	●	●
Plain / T&G Panel	Made to Measure per m2	×	●	●	●

*Unfinished MTM - These items will be supplied as unfinished MDF.



Plain Panel / 18mm Thick

EXS PTO MTM

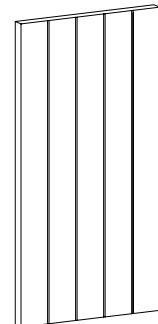

T&G Panel / 18mm Thick

EXS PTO MTM

EXS Available Primed Ex.Stock. Ready for 48h despatch.

PTO Available Painted to Order standard sizes.

MTM Available Made to Measure Unfinished / Painted.

Greenwich Ash | Solid Timber Matt Painted Door

Solid Timber Painted | Ex.Stock and MTM





ALSO AVAILABLE IN OAK





Door Specification

Description	Flat Beaded Shaker Door with 105mm Stiles
Finish	Matt Painted Finish
Door Thickness	21mm Thick
Base Material	Solid Ash Core with a Veneered Centre Panel
Edge	1mm Bevelled Edge

- 

Available Primed Ex.Stock
- 

32 Painted Colours
- 

Available Painted to Order standard sizes.
- 

Available Made to Measure
- 

Solid Ash Timber



Greenwich Ash Door



Greenwich Ash Frame



Greenwich Ash Curved Door



Greenwich Ash Pan Drawer

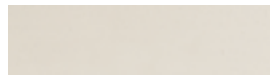

Greenwich Ash Drawer

Greenwich Ash | Colours / Finishes

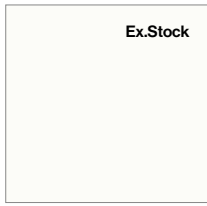

Primed

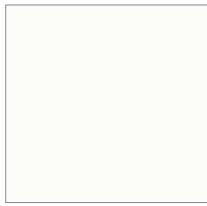

White

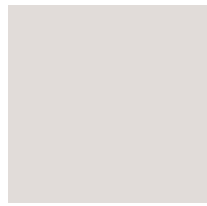

Taupe

Colours swatches shown are approximate.

See Painted Swatch Book for true colour match.

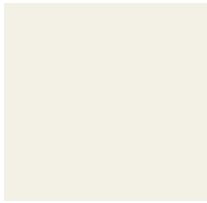

Porcelano



Highland Grey

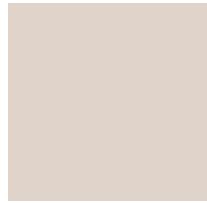

Cashmere



Sea Breeze



Light Blue

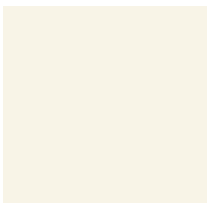

Ivory

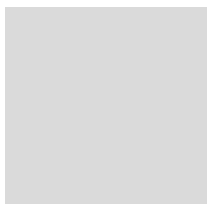

Light Grey



French Chalk



Sage



Denim

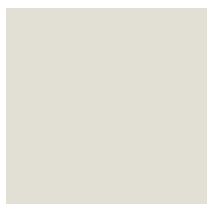

Mussel

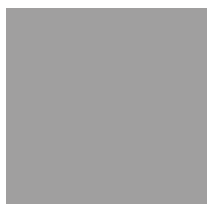

Dust Grey



Heritage Pink



Liberty Green



Eiffel Blue

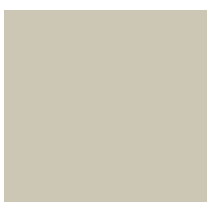

Dakar

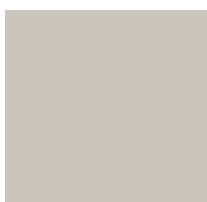

Pebble

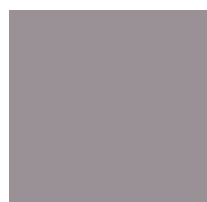

French Lavender



Moss Green



Nautical



Stone Grey



Graphite

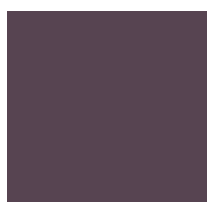

Foraged Fruit



Heritage Green



Marine Blue



Honeycomb



Carbon Black



Heritage Red

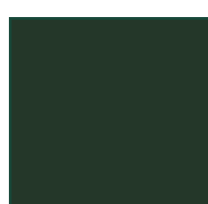

Conifer



Indigo

Greenwich Ash | Door and Drawer Sizes

Solid Timber Painted | Ex Stock and MTM



Kitchen Door Sizes						
Doors Sizes	EXS	PTO	MTM	Curved Door sizes	EXS	PTO
115 x 596				716 x 300		
140 x 296				896 x 300		
140 x 396						
140 x 446						
140 x 496						
140 x 596						
140 x 796						
140 x 896						
140 x 996						
176 x 396						
176 x 496						
176 x 596						
284 x 496						
284 x 596						
284 x 796						
284 x 896						
284 x 996						
356 x 496						
356 x 596						
356 x 796						
356 x 896						
356 x 996						
450 x 596						
496 x 396						
496 x 596						
570 x 296						

Plain Frame Sizes				
EXS	PTO	MTM		
			716 x 396 (Glazed)	
			716 x 496 (Glazed)	
			896 x 496 (Glazed)	
			1060 x 496 (Glazed)	

Handleless Rail System / Door Sizes				
Kitchen Door Sizes			MTM	
160 x 296	325 x 596	685 x 146		
160 x 396	325 x 796	685 x 296		
160 x 446	325 x 896	685 x 315		
160 x 496	325 x 996	685 x 346		
160 x 596	490 x 296	685 x 396		
160 x 796	490 x 396	685 x 446		
160 x 896	490 x 446	685 x 496		
160 x 996	490 x 496	685 x 596		
325 x 496	490 x 596			

Drilling - Additional charge per hole.

Non-Standard Kitchen Door Sizes - Priced as MTM.
Angled Doors are not available.

Primed MTM Sizes are not available.
MTM timber doors cannot be cancelled once ordered.
MTM Timber doors are non-returnable.

Non-Standard Curved Door Sizes are not available.
Concave Doors are not available.

Standard Plain Frame Sizes - Supplied Glazed.
Non Standard Plain Frame Sizes - Supplied Unglazed.
Non Standard Plain Frame Sizes - Priced as door size plus 35%.
Non Standard Top Open Feature Frame Sizes - Priced as door size plus 35%.
Georgian Frame Sizes are not available.

Drilling - Additional charge per hole.

Greenwich Ash | Technical Specification

Solid Timber Doors:

Door sizes between 283mm - 1245mm high are supplied as single panels as standard. Maximum Door Width is 996mm. Minimum Door Width is 246mm.

Stile width will be reduced as necessary for Doors sized below 296mm wide.

Angled doors are not available.

Solid Timber Drawers:

Drawer sizes between 50mm - 200mm high are supplied as flat panels as standard. Maximum Drawer width is 1196mm. Minimum Drawer width is 100mm.

Pan Drawer sizes between 283mm - 400mm high are supplied as single panels as standard. Maximum Pan Drawer width is 1196mm. Minimum Pan Drawer width is 246mm.

Stile width will be reduced as necessary for Pan Drawers sized below 296mm wide.

Please note it's important to specify either Door, Drawer or Pan Drawer when ordering to ensure your order is processed correctly.

Solid Timber Frames:

Plain Frame sizes between 283mm - 1245mm high are supplied as single panels as standard. Maximum Plain Frame width is 996mm. Minimum Plain Frame width is 246mm.

Stile width will be reduced as necessary for Plain Frames sized below 296mm wide.

Standard Kitchen Frame sizes are supplied glazed. Non Standard Kitchen and Bedroom Frame sizes are supplied unglazed. Unglazed frames are rebated on the reverse side and supplied with a glazing gasket.

MTM Georgian Frames not available. Angled Frames are not available.

Solid Timber Curved Doors:

Solid Timber Curved doors are made to suit 300 x 300mm cabinets only. Solid Timber Curved Doors are available in standard listed sizes only.

MTM Solid Timber Doors are not available. Concave doors are not available.

Drilling:

All door styles are supplied un-drilled unless requested by the customer. If drilling is required, drilling instructions must clearly state full dimensions for all holes required.

Greenwich Ash Door Cross Section

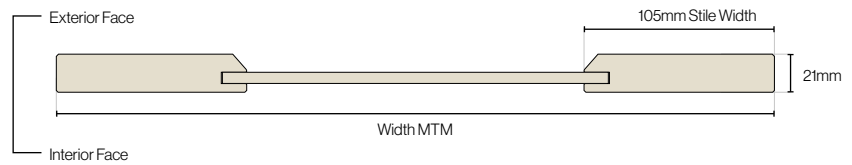

Greenwich Ash Stile Cross Section

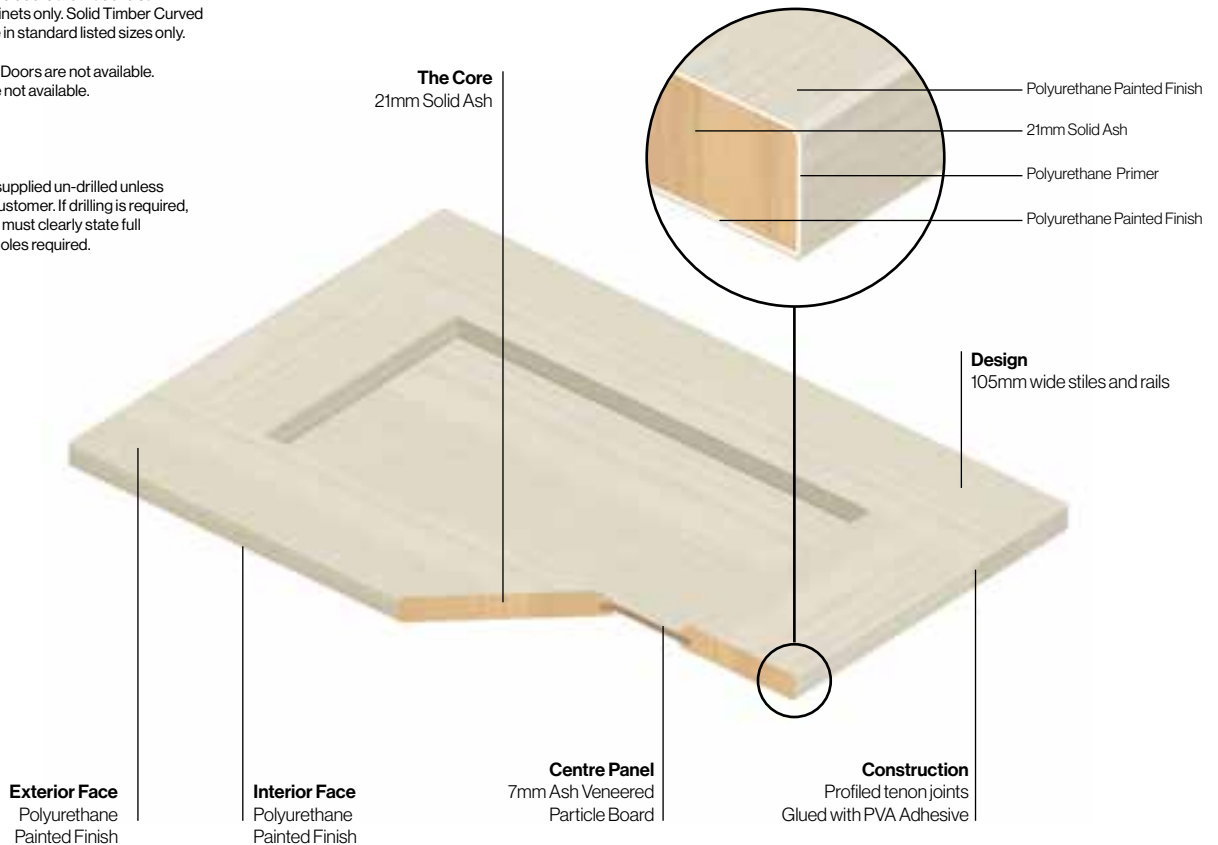
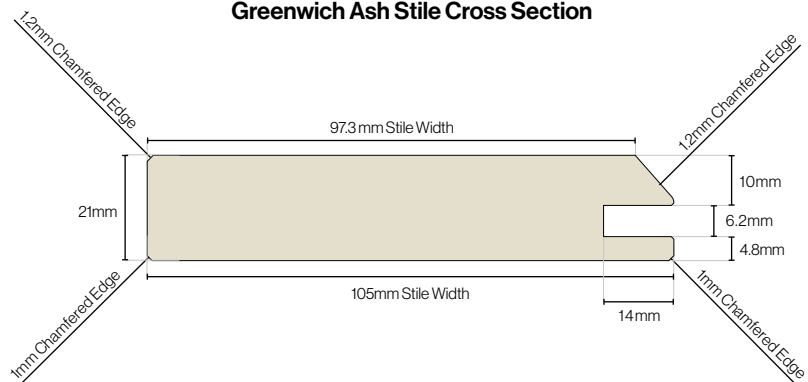

Greenwich Ash | Accessories

Solid Timber Painted | Ex:Stock and MTM

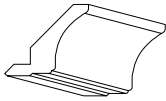

Classic Cornice (Grained)
76mm (W) x 63mm (H)
3050mm Lengths

EXS PTO

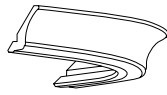

Curved Classic Cornice
364mm (L) x 364mm (W)
x 63mm (H)

EXS PTO



Classic Cornice Quadrant
84mm (L) x 84mm (W)
x 63mm (H)

EXS PTO

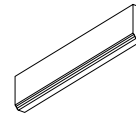

Tangent Light Pelmet
18mm (W) x 57mm (H)
3050mm Lengths

EXS PTO

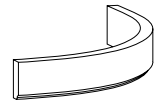

Curved Tangent Pelmet
300mm (L) x 300mm (W)
x 57mm (H)

EXS PTO

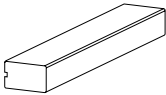

Modern Cornice / Pelmet
50mm (W) x 30mm (H)
3050mm Lengths

EXS PTO

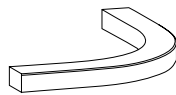

Curved Modern Cornice Pelmet
350mm (L) x 350mm (W)
x 30mm (H)

EXS PTO

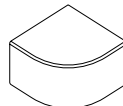

Modern Cornice / Pelmet Quadrant
50mm (L) x 50mm (W)
x 30mm (H)

EXS PTO

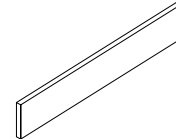

Plain Plinth
18mm (W) x 150mm (H)
2850mm Lengths

EXS PTO



Curved Plain Plinth
540mm (L) x 232mm (W)
x 150mm (H)

EXS PTO

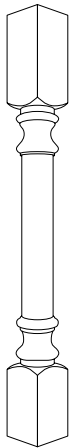

Turned Pilaster
30mm (L) x 30mm (W)
x 720mm (H)

EXS PTO



Corner Post
30mm (L) x 30mm (W)
x 720mm (H)

EXS PTO

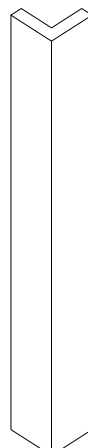

MTM Corner Post
715mm (150 x 150mm Max)

MTM

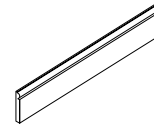

Torus Plinth
18mm (W) x 150mm (H)
3050mm Lengths

EXS PTO



Radius Profile
(R 48mm) 70mm (W) x 50mm (H)
3050mm Lengths

EXS PTO

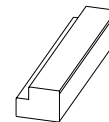

Square Base Pilaster
965mm (L) x 70mm (W)
x 50mm (H)

EXS PTO

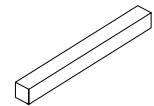

Square Base Pilaster Insert
965mm (L) x 19mm (W)
x 19mm (H)

EXS PTO

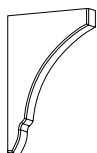

Shelf Bracket
100mm (L) x 18mm (W)
x 150mm (H)

EXS PTO

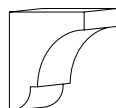

Corbel
125mm (L) x 90mm (W)
x 165mm (H)

EXS PTO



French Mantle Corbel
350mm (L) x 90mm (W)
x 600mm (H)

EXS PTO

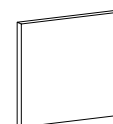

Corbel Back Panel
284mm (W) x 18mm (W)
x 296mm (H)

EXS PTO

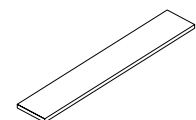

Mantle Shelf
1784mm (L) x 180mm (W)
x 18mm (H)

EXS PTO

Greenwich Ash | Accessories

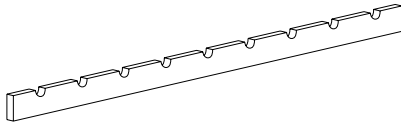

Wine Rack Rail
1200mm (L) x 18mm (W) x 60mm (H)

EXS PTO

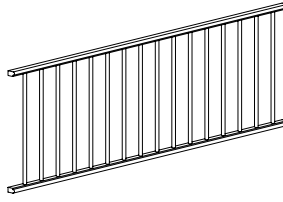
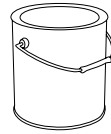
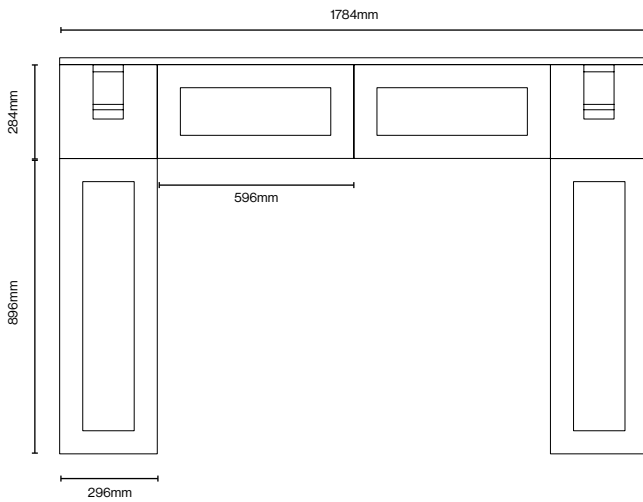

Plate Cot (Pair)
1000mm (L) x 23mm (W) x 308mm (H)

EXS PTO



Touch Up Paint
Available 30ml or 1Litre volumes.



Greenwich Overmantle Kit
Includes: 2 x Classic Corbels / 2 x Corbel back Panels / 2 x Doors 896 x 296mm / 2 x Drawers 284 x 596mm / 1 x Mantle Shelf

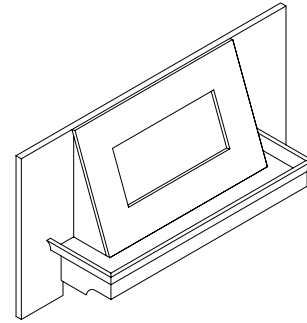

Modern Canopy
1000mm (W) x 228mm (D) x 525mm (H)

EXS PTO

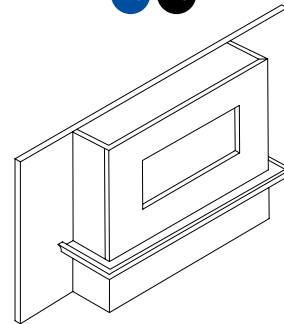

Classic Canopy
1000mm (W) x 215mm (D) x 485mm (H)

MTM

Panel	Size MM	Primed Ex.Stock	Painted To Order	Unfinished MTM*	Painted MTM
Plain / T&G Panel	18mm / 785 x 360mm	●	●	●	●
Plain / T&G Panel	18mm / 900 x 360mm	●	●	●	●
Plain / T&G Panel	18mm / 900 x 650mm	●	●	●	●
Plain / T&G Panel	18mm / 900 x 864mm	●	●	●	●
Plain / T&G Panel	18mm / 900 x 1160mm	●	●	●	●
Plain / T&G Panel	18mm / 900 x 1200mm	●	●	●	●
Plain / T&G Panel	18mm / 965 x 360mm	●	●	●	●
Plain / T&G Panel	18mm / 2400 x 360mm	●	●	●	●
Plain / T&G Panel	18mm / 2400 x 650mm	●	●	●	●
Plain / T&G Panel	18mm / 2400 x 900mm	●	●	●	●
Plain / T&G Panel	Made to Measure per m2	×	●	●	●

*Unfinished MTM - These items will be supplied as unfinished MDF.

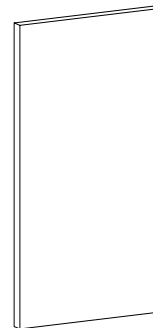

Plain Panel / 18mm Thick

EXS PTO MTM

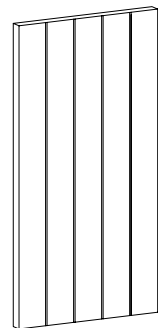

T&G Panel / 18mm Thick

EXS PTO MTM

EXS Available Primed Ex.Stock. Ready for 48h despatch.

PTO Available Painted to Order standard sizes.

MTM Available Made to Measure Unfinished / Painted.

Greenwich Oak | Solid Timber Matt Painted Door

Solid Timber Painted | Ex.Stock and MTM



Door Specification	
Description	Flat Beaded Shaker Door with 105mm Stiles
Finish	Sanded or Lacquered Oak Finish
Door Thickness	21mm Thick
Base Material	Solid Oak Core with a Veneered Centre Panel
Edge	1mm Radius Edge

- 

Available
Primed Ex.Stock
- 

Available Lacquered
to Order standard
- 

Available
Made to Measure
- 

Solid Ash
Timber



Greenwich Oak Door



Greenwich Oak Frame



Greenwich Oak Curved Door



Greenwich Oak Pan Drawer



Greenwich Oak Drawer

Greenwich Oak | Kitchen Door Sizes

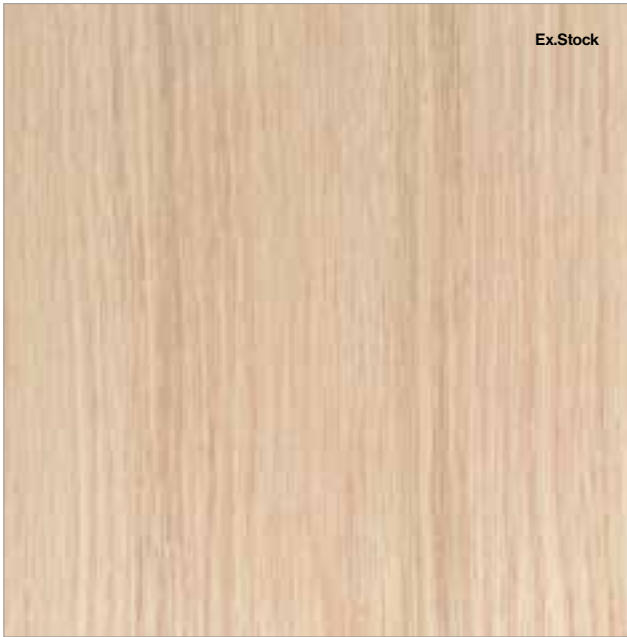

Ex.Stock

Sanded Oak



Natural Oak Lacquer

Solid Timber Painted | Ex.Stock and MTM

Greenwich Oak | Door and Drawer Sizes

Solid Timber Painted | Ex,Stock and MTM



Kitchen Door Sizes			
Doors Sizes	EXS	LTO	MTM
115 x 596			
140 x 296			
140 x 396			
140 x 446			
140 x 496			
140 x 596			
140 x 796			
140 x 896			
140 x 996			
176 x 396			
176 x 496			
176 x 596			
284 x 496			
284 x 596			
284 x 796			
284 x 896			
284 x 996			
356 x 496			
356 x 596			
356 x 796			
356 x 896			
356 x 996			
450 x 596			
496 x 396			
496 x 596			
570 x 296			

Curved Door sizes			
	EXS	LTO	
716 x 300			
896 x 300			

Plain Frame Sizes			
	EXS	LTO	MTM
716 x 396 (Glazed)			
716 x 496 (Glazed)			
896 x 496 (Glazed)			
1060 x 496 (Glazed)			

Handleless Rail System / Door Sizes			
Kitchen Door Sizes			MTM
160 x 296	325 x 596	685 x 146	
160 x 396	325 x 796	685 x 296	
160 x 446	325 x 896	685 x 315	
160 x 496	325 x 996	685 x 346	
160 x 596	490 x 296	685 x 396	
160 x 796	490 x 396	685 x 446	
160 x 896	490 x 446	685 x 496	
160 x 996	490 x 496	685 x 596	
325 x 496	490 x 596		

Drilling - Additional charge per hole.

Non-Standard Kitchen Door Sizes - Priced as MTM.
Angled Doors are not available.

MTM timber doors cannot be cancelled once ordered.
MTM Timber doors are non-returnable.

Non-Standard Curved Door Sizes are not available.
Concave Doors are not available.

Standard Plain Frame Sizes - Supplied Glazed.
Non Standard Plain Frame Sizes - Supplied Unglazed.
Non Standard Plain Frame Sizes - Priced as door size plus 35%.
Non Standard Top Open Feature Frame Sizes - Priced as door size plus 35%.
Georgian Frame Sizes are not available.

Drilling - Additional charge per hole.



Greenwich Oak | Technical Specification

Solid Timber Doors:

Door sizes between 283mm - 1245mm high are supplied as single panels as standard. Maximum Door Width is 996mm. Minimum Door Width is 246mm.

Stile width will be reduced as necessary for Doors sized below 296mm wide.

Angled doors are not available.

Solid Timber Drawers:

Drawer sizes between 50mm - 200mm high are supplied as flat panels as standard. Maximum Drawer width is 1196mm. Minimum Drawer width is 100mm.

Pan Drawer sizes between 283mm - 400mm high are supplied as single panels as standard. Maximum Pan Drawer width is 1196mm. Minimum Pan Drawer width is 246mm.

Stile width will be reduced as necessary for Pan Drawers sized below 296mm wide.

Please note it's important to specify either Door, Drawer or Pan Drawer when ordering to ensure your order is processed correctly.

Solid Timber Frames:

Plain Frame sizes between 283mm - 1245mm high are supplied as single panels as standard. Maximum Plain Frame width is 996mm. Minimum Plain Frame width is 246mm.

Stile width will be reduced as necessary for Plain Frames sized below 296mm wide.

Standard Kitchen Frame sizes are supplied glazed. Non Standard Kitchen and Bedroom Frame sizes are supplied unglazed. Unglazed frames are rebated on the reverse side and supplied with a glazing gasket.

MTM Georgian Frames not available. Angled Frames are not available.

Solid Timber Curved Doors:

Solid Timber Curved doors are made to suit 300 x 300mm cabinets only. Solid Timber Curved Doors are available in standard listed sizes only.

MTM Solid Timber Doors are not available. Concave doors are not available.

Drilling:

All door styles are supplied un-drilled unless requested by the customer. If drilling is required, drilling instructions must clearly state full dimensions for all holes required.

Greenwich Ash Door Cross Section

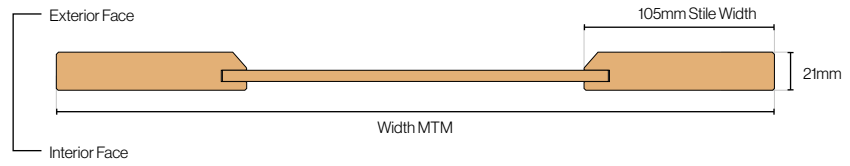

Greenwich Ash Stile Cross Section

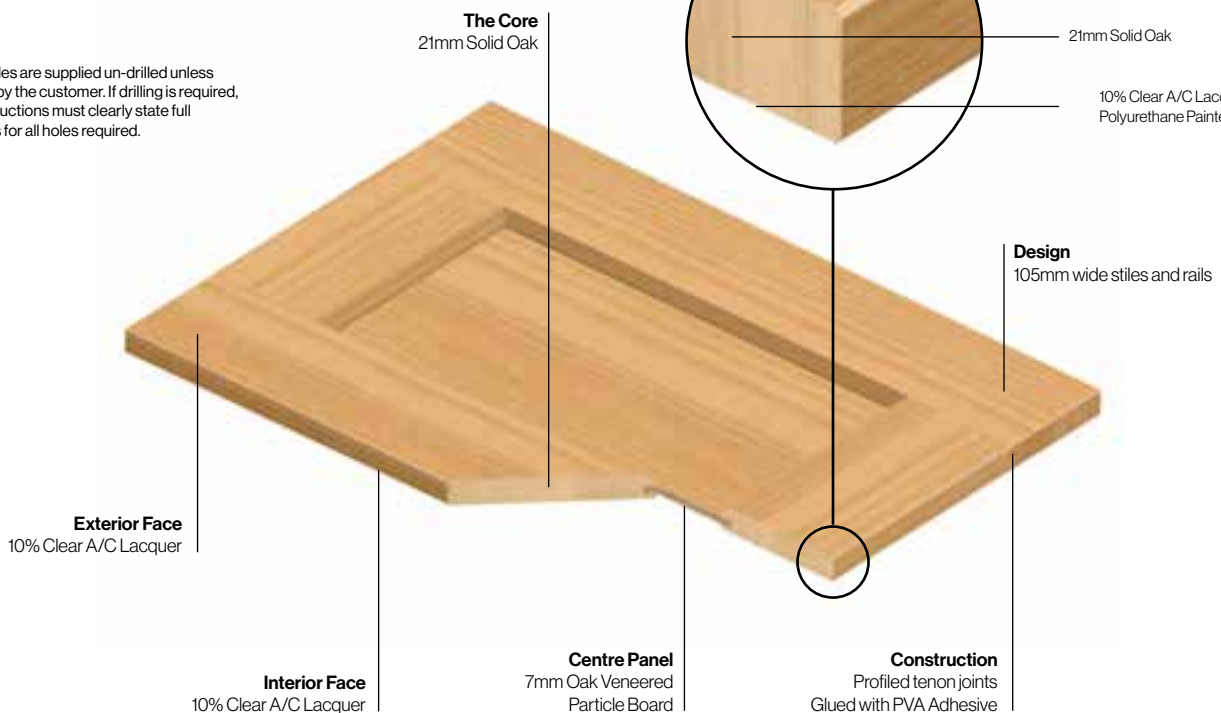
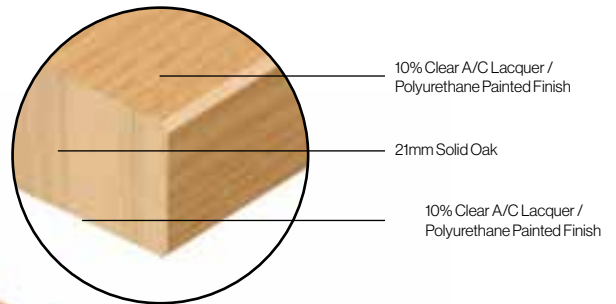

Greenwich Oak | Accessories

Solid Timber Painted | Ex:Stock and MTM

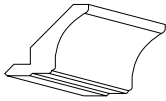

Classic Cornice (Grained)
76mm (W) x 63mm (H)
3050mm Lengths

EXS LTO

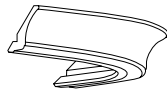

Curved Classic Cornice
364mm (L) x 364mm (W)
x 63mm (H)

EXS LTO

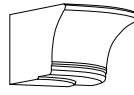

Classic Cornice Quadrant
84mm (L) x 84mm (W)
x 63mm (H)

EXS LTO

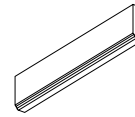

Tangent Light Pelmet
18mm (W) x 57mm (H)
3050mm Lengths

EXS LTO

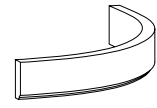

Curved Tangent Pelmet
300mm (L) x 300mm (W)
x 57mm (H)

EXS LTO

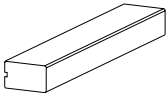

Modern Cornice / Pelmet
50mm (W) x 30mm (H)
3050mm Lengths

EXS LTO

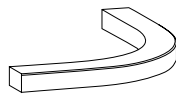

Curved Modern Cornice Pelmet
350mm (L) x 350mm (W)
x 30mm (H)

EXS LTO

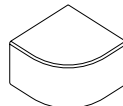

Modern Cornice / Pelmet Quadrant
50mm (L) x 50mm (W)
x 30mm (H)

EXS LTO

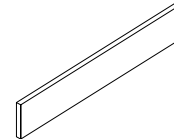

Plain Plinth
18mm (W) x 150mm (H)
2850mm Lengths

EXS LTO



Curved Plain Plinth
540mm (L) x 232mm (W)
x 150mm (H)

EXS LTO

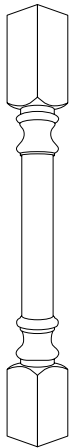

Turned Pilaster
30mm (L) x 30mm (W)
x 720mm (H)

EXS PTO



Corner Post
30mm (L) x 30mm (W)
x 720mm (H)

EXS LTO

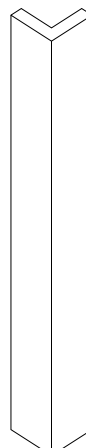

MTM Corner Post
715mm (150 x 150mm Max)

MTM

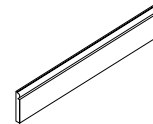

Torus Plinth
18mm (W) x 150mm (H)
3050mm Lengths

EXS LTO



Radius Profile
(R 48mm) 70mm (W) x 50mm (H)
3050mm Lengths

EXS LTO

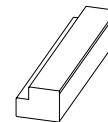

Square Base Pilaster
965mm (L) x 70mm (W)
x 50mm (H)

EXS LTO

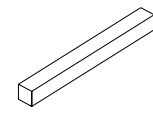

Square Base Pilaster Insert
965mm (L) x 19mm (W)
x 19mm (H)

EXS LTO

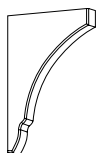

Shelf Bracket
100mm (L) x 18mm (W)
x 150mm (H)

EXS PTO

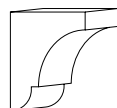

Corbel
125mm (L) x 90mm (W)
x 165mm (H)

EXS PTO



French Mantle Corbel
350mm (L) x 90mm (W)
x 600mm (H)

EXS PTO

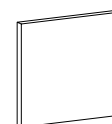

Corbel Back Panel
284mm (W) x 18mm (W)
x 296mm (H)

EXS PTO

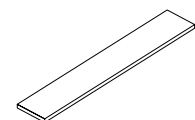

Mantle Shelf
1784mm (L) x 180mm (W)
x 18mm (H)

EXS PTO

Greenwich Oak | Accessories

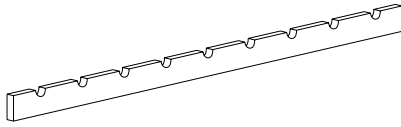

Wine Rack Rail
1200mm (L) x 18mm (W) x 60mm (H)

EXS LTO

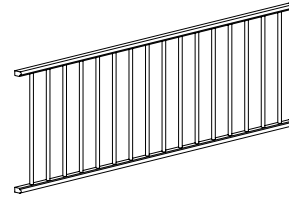
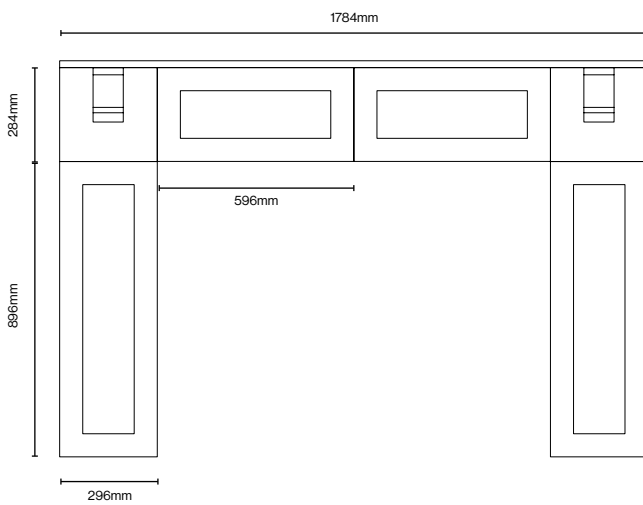

Plate Cot (Pair)
1000mm (L) x 23mm (W) x 308mm (H)

EXS LTO



Greenwich Oak Overmantle Kit

Includes: 2 x Classic Corbels / 2 x Corbel back Panels / 2 x Doors 896 x 296mm / 2 x Drawers 284 x 596mm / 1 x Mantle Shelf

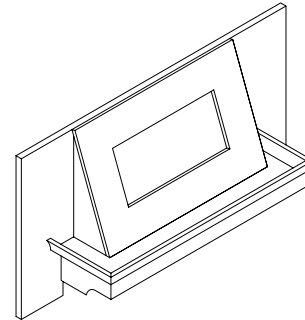

Modern Canopy
1000mm (W) x 228mm (D) x 525mm (H)

EXS PTO

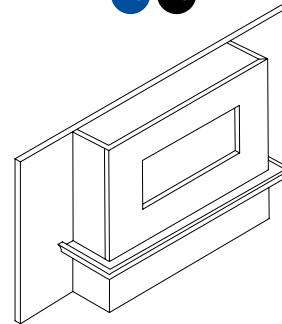

Classic Canopy
1000mm (W) x 215mm (D) x 485mm (H)

MTM

Panel	Size MM	Sanded Ex.Stock	Lacquered To Order	Sanded MTM	Lacquered MTM
Plain / T&G Panel	18mm / 785 x 360mm	●	●	●	●
Plain / T&G Panel	18mm / 900 x 360mm	●	●	●	●
Plain / T&G Panel	18mm / 900 x 650mm	●	●	●	●
Plain / T&G Panel	18mm / 900 x 864mm	●	●	●	●
Plain / T&G Panel	18mm / 900 x 1160mm	●	●	●	●
Plain / T&G Panel	18mm / 900 x 1200mm	●	●	●	●
Plain / T&G Panel	18mm / 965 x 360mm	●	●	●	●
Plain / T&G Panel	18mm / 2400 x 360mm	●	●	●	●
Plain / T&G Panel	18mm / 2400 x 650mm	●	●	●	●
Plain / T&G Panel	18mm / 2400 x 900mm	●	●	●	●
Plain / T&G Panel	Made to Measure per m2	×	●	●	●



Plain Panel / 18mm Thick

EXS LTO MTM

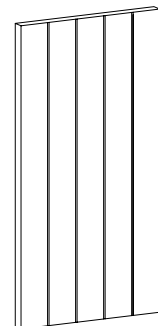

T&G Panel / 18mm Thick

EXS LTO MTM

Hyde | Grained MDF Matt Painted Door

Solid Timber Painted | MDF Matt Painted (Grained)



Door Specification

Description	Embossed Wood Grain Effect, Slab Style Door
Finish	Matt Painted Finish
Door Thickness	18mm Thick
Base Material	Moisture Resistant MDF Core
Edge	Paint-able 1mm ABS Edging



32 Painted Colours



Available Painted to Order standard sizes.



Available Made to Measure



Available Unfinished*



Embossed Grain



Hyde | Kitchen Door Sizes



Primed



White

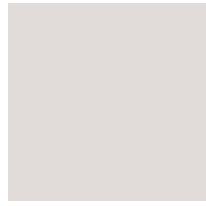

Taupe

Colours swatches shown are approximate.

See Painted Swatch Book for true colour match.

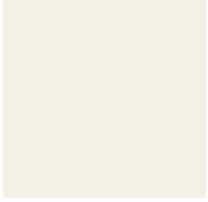

Porcelano

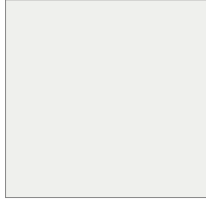

Highland Grey

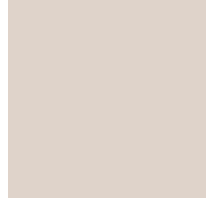

Cashmere



Sea Breeze

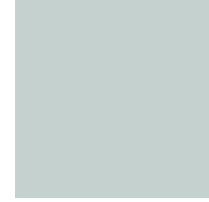

Light Blue

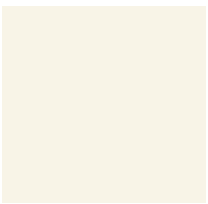

Ivory

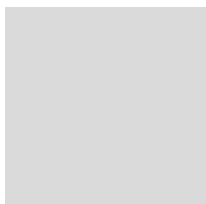

Light Grey



French Chalk



Sage



Denim

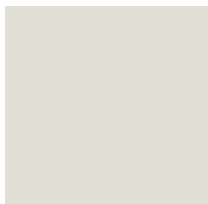

Mussel

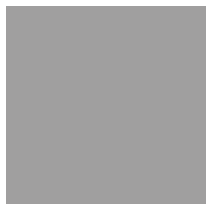

Dust Grey



Heritage Pink



Liberty Green



Eiffel Blue



Dakar

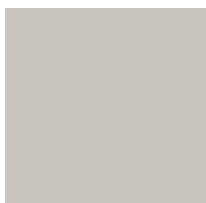

Pebble

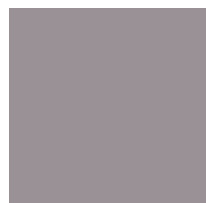

French Lavender



Moss Green



Nautical

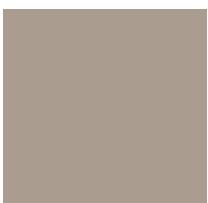

Stone Grey

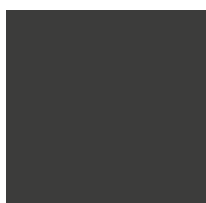

Graphite

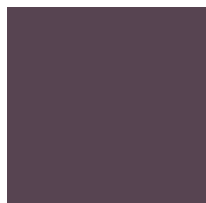

Foraged Fruit



Heritage Green



Marine Blue



Honeycomb



Carbon Black



Heritage Red

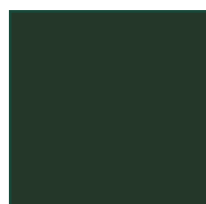

Conifer



Indigo

Hyde | Bedroom Door Sizes

Solid Timber Painted | MDF Matt Painted (Grained)



Kitchen Door Sizes

Doors Sizes		MTM	Curved Door sizes		MTM
115 x 596	570 x 446		715 x 300		
140 x 296	570 x 496		895 x 300		
140 x 396	570 x 596		1245 x 300		
140 x 446	645 x 596		1965 x 300		
140 x 496	715 x 146				
140 x 596	715 x 246				
140 x 796	715 x 275				
140 x 896	715 x 296				
140 x 996	715 x 315				
175 x 396	715 x 346				
175 x 496	715 x 396				
175 x 596	715 x 446				
283 x 496	715 x 496				
283 x 596	715 x 546				
283 x 796	715 x 596				
283 x 896	895 x 296				
283 x 996	895 x 396				
355 x 496	895 x 446				
355 x 596	895 x 496				
355 x 760	895 x 596				
355 x 796	980 x 596				
355 x 896	1060 x 396				
355 x 996	1060 x 496				
450 x 596	1060 x 596				
495 x 396	1245 x 296				
495 x 596	1245 x 396				
570 x 296	1245 x 496				
570 x 396	1245 x 596				

Non-Standard Kitchen Door Sizes - Priced next door size up.

Angled Kitchen Door Sizes - Priced as door size plus 50%.

Primed MTM Sizes are not available.

Unfinished MTM - These doors will be supplied as raw MDF.

Curved Kitchen Doors available any height up to 2250mm

Non-Standard Curved Kitchen Door Sizes - Priced next door size up.

MTM Plain Kitchen Frames - Priced as door size plus 35% (Supplied Unglazed).

Drilling - Additional charge per hole.



Bedroom Door Sizes

Doors and Drawer Sizes		MTM	Curved Door Sizes		MTM
215 x 296	1495 x 596		1495 x 300		
215 x 396	1595 x 296		1595 x 300		
215 x 446	1595 x 396		2150 x 300		
215 x 496	1595 x 446		2250 x 300		
215 x 546	1595 x 496				
215 x 596	1595 x 596				
215 x 796	1735 x 296				
215 x 896	1735 x 396				
215 x 996	1735 x 446				
415 x 296	1735 x 496				
415 x 396	1735 x 596				
415 x 446	2150 x 296				
415 x 496	2150 x 396				
415 x 596	2150 x 446				
535 x 296	2150 x 496				
535 x 396	2150 x 596				
535 x 446	2250 x 296				
535 x 496	2250 x 396				
535 x 596	2250 x 446				
650 x 296	2250 x 496				
650 x 396	2250 x 596				
650 x 446	2400 x 296				
650 x 496	2400 x 396				
650 x 596	2400 x 446				
1495 x 296	2400 x 496				
1495 x 396	2400 x 596				
1495 x 446					
1495 x 496					

Non-Standard Bedroom Door Sizes - Priced next door size up.

Angled Bedroom Door Sizes - Priced as door size plus 50%.

Primed MTM Sizes are not available.

Unfinished MTM - These doors will be supplied as raw MDF.

Curved Bedroom Doors available any height up to 2250mm

Non-Standard Curved Bedroom Door Sizes - Priced next door size up.

MTM Plain Bedroom Frames - Priced as door size plus 35% (Supplied Unglazed).

Drilling - Additional charge per hole.

Hyde | Handleless Rail System Door Sizes



Plain Panel
(18mm thick)



Internal Corner Post
685 x 70 x 70mm



External Corner Post
685 x 46 x 46mm



Handleless Rail System Door Sizes

Kitchen Door Sizes		Bedroom Door Sizes		
160 x 296	490 x 296	1400 x 263	1500 x 413	2150 x 563
160 x 396	490 x 396	1400 x 281	1500 x 431	2150 x 581
160 x 446	490 x 446	1400 x 313	1500 x 463	2250 x 263
160 x 496	490 x 496	1400 x 331	1500 x 481	2250 x 281
160 x 596	490 x 596	1400 x 363	1500 x 513	2250 x 313
160 x 796	685 x 146	1400 x 381	1500 x 531	2250 x 331
160 x 896	685 x 296	1400 x 413	1500 x 563	2250 x 363
160 x 996	685 x 315	1400 x 431	1500 x 581	2250 x 381
325 x 496	685 x 346	1400 x 463	2150 x 263	2250 x 413
325 x 596	685 x 396	1400 x 481	2150 x 281	2250 x 431
325 x 796	685 x 446	1400 x 513	2150 x 313	2250 x 463
325 x 896	685 x 496	1400 x 531	2150 x 331	2250 x 481
325 x 996	685 x 596	1400 x 563	2150 x 363	2250 x 513
		1400 x 581	2150 x 381	2250 x 531
		1500 x 263	2150 x 413	2250 x 563
		1500 x 281	2150 x 431	2250 x 581
		1500 x 313	2150 x 463	
		1500 x 331	2150 x 481	
		1500 x 363	2150 x 513	
		1500 x 381	2150 x 531	

Drilling - Additional charge per hole.

Save time & money with **automatic pricing** through our online ordering service.



Order online at weborders.osdoors.com

Important: Always ensure doors are shielded from heat sources through the use of heat deflectors.

See page 226 for full range of heat deflector sizes.



Hyde | Door Specifications

Solid Timber Painted | MDF Matt Painted (Grained)

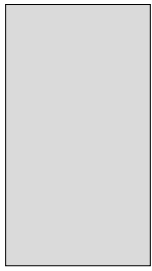

Hyde Kitchen Door

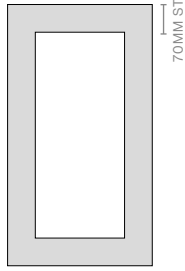

Hyde Kitchen Frame (Unglazed)



Hyde Kitchen Curved Door



Hyde Drawer



Hyde Pan Drawer

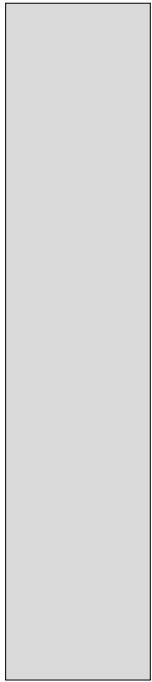

Hyde Bedroom Door

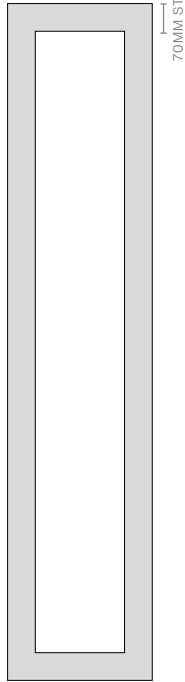

Hyde Bedroom Full Open Frame

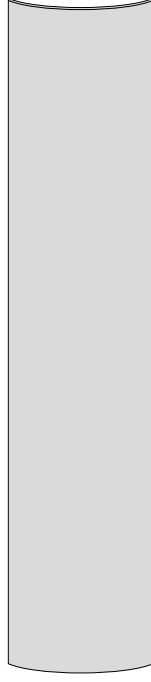

Hyde Bedroom Curved Door

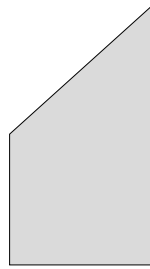

Hyde Kitchen Angled Door

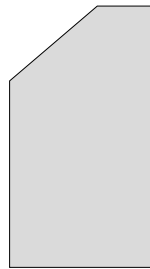

Hyde Kitchen Angled Flat Top Door

Hyde Kitchen Doors:

Kitchen Door sizes between 250mm - 1734mm high are supplied flat panel as standard. Minimum Kitchen Door width is 246mm.

Hyde Drawers:

Drawer sizes between 100mm - 282mm high are supplied flat panel as standard. Minimum Drawer width is 246mm.

Pan Drawer sizes between 250mm - 282mm high are supplied flat panel as standard. Minimum Pan Drawer width is 246mm.

Please note it's important to specify either Door, Drawer or Pan Drawer when ordering to ensure your order is processed correctly.

Hyde Frames:

Frames between 250mm - 2400mm high are supplied flat panel Full Open Frames with a 70mm stile as standard.

Top Open Frames between 1735mm - 2400mm high are supplied with a double mid rail which position is variable for each order (please specify required dimensions of split dimensions). The mid rail is measured from the base of the door to the centre of the mid rail unless otherwise specified.

If you require a Top Open Frame this must be clearly stated when ordering, and full details on sizes required must be included.

Hyde Curved Doors:

Curved doors are made to suit 300mm x 300mm cabinets only. Height availability ranges from 570mm up to 2250mm.

Hyde Bedroom Doors:

Bedroom Door sizes between 1735mm - 2400mm high are supplied flat panel as standard. Minimum Bedroom Door width is 246mm.

Hyde Direction:

Door sizes between 250mm - 2400mm are supplied with vertical grain as standard. Horizontal grain (up to 1220mm only) is available on request.

Drawer sizes between 100mm - 282mm are supplied with horizontal grain as standard. Vertical grain is available on request.

Drilling:

All door styles are supplied un-drilled unless requested by the customer. If drilling is required, drilling instructions must clearly state full dimensions for all holes required.

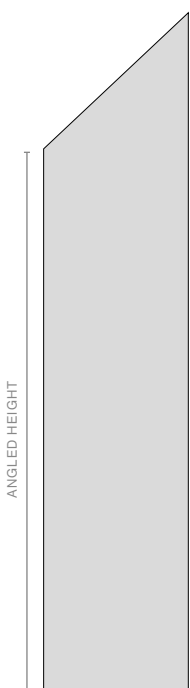

Hyde Bedroom Angled Left Hand Door

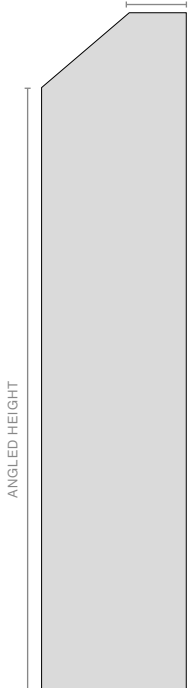

Hyde Bedroom Angled Flat Top Left Hand Door

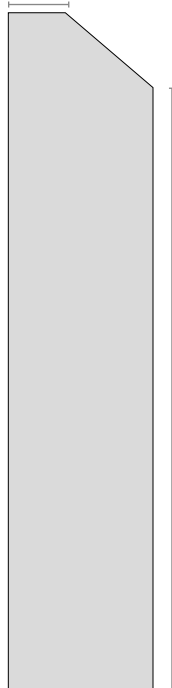

Hyde Bedroom Angled Flat Top Right Hand Door

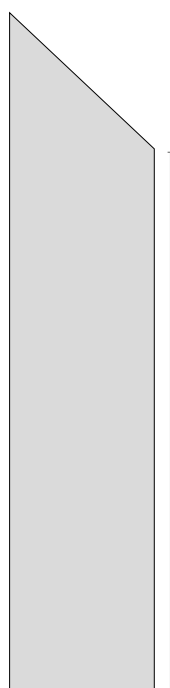

Hyde Bedroom Angled Right Hand Door

Hyde | Technical Specifications

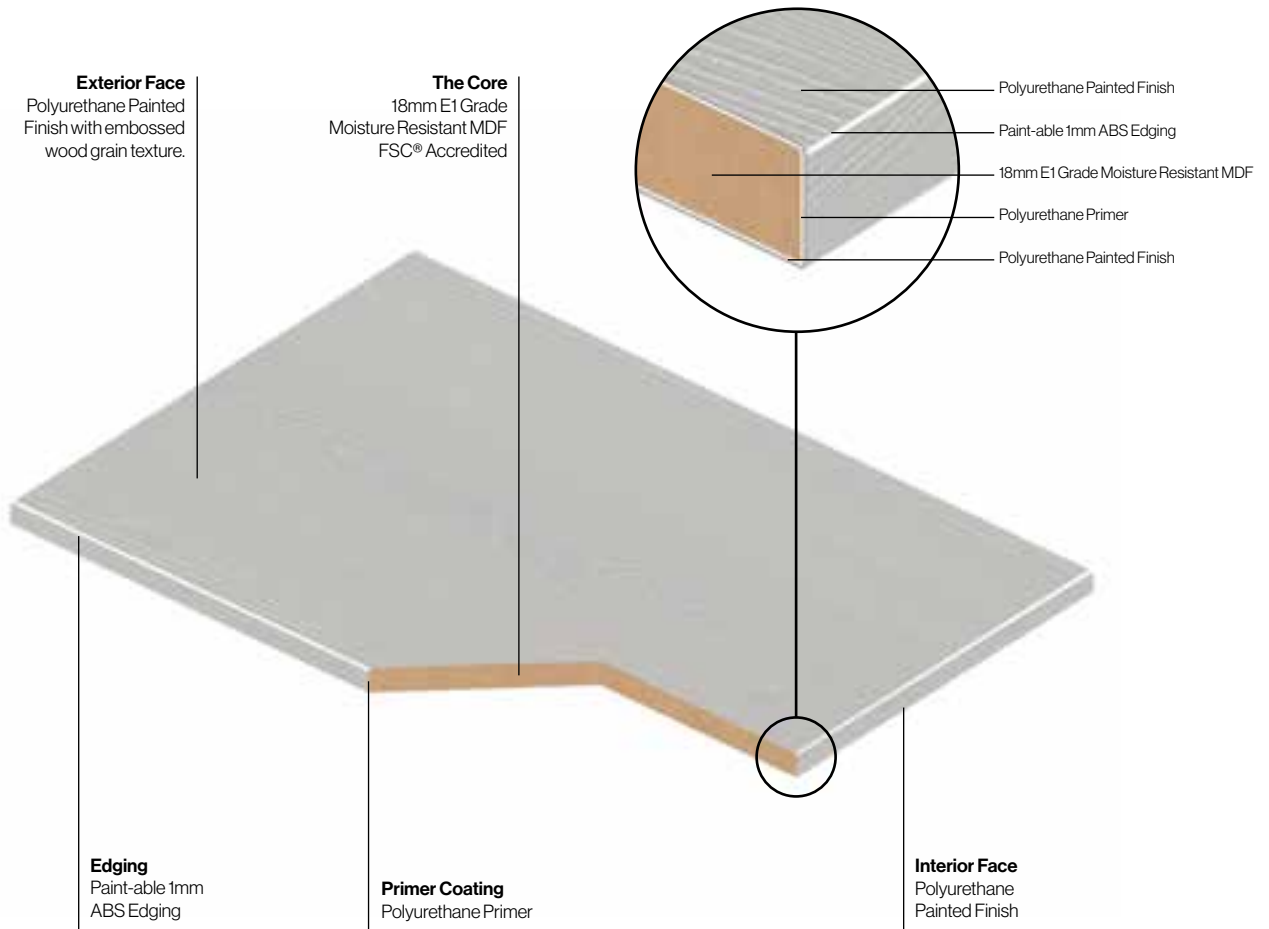

Solid Timber Painted | MDF Matt Painted (Grained)

Hyde | Accessories

Solid Timber Painted | MDF Matt Painted (Grained)

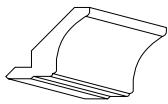

Classic Cornice (Grained)
76mm (W) x 63mm (H)
3050mm Lengths

EXS PTO

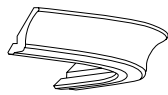

Curved Classic Cornice
364mm (L) x 364mm (W)
x 63mm (H)

EXS PTO



Classic Cornice Quadrant
84mm (L) x 84mm (W)
x 63mm (H)

EXS PTO

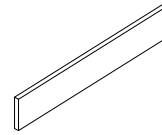

Plain Plinth
18mm (W) x 150mm (H)
3050mm Lengths

EXS PTO

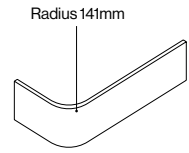

Curved Plain Plinth
540mm (L) x 232mm (W)
x 150mm (H)

EXS PTO

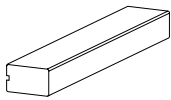

Modern Cornice / Pelmet
50mm (W) x 30mm (H)
3050mm Lengths

EXS PTO

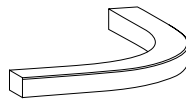

Curved Modern Cornice / Pelmet
350mm (L) x 350mm (W)
x 30mm (H)

EXS PTO

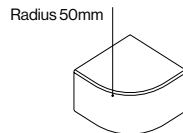

Modern Cornice / Pelmet Quadrant
50mm (L) x 50mm (W) x 30mm (H)

EXS PTO

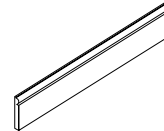

Torus Plinth
18mm (W) x 150mm (H)
3050mm Lengths

EXS PTO

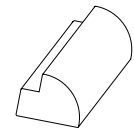

Radius Profile (R 48mm)
70mm (W) x 50mm (H)
3050mm Lengths

EXS PTO

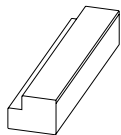

Square Base Pilaster
70mm (W) x 50mm (H)
3050mm Lengths

EXS PTO

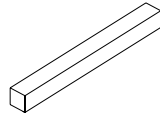

Square Base Pilaster Insert
965mm (L) x 18mm (W)
x 18mm (H)

EXS PTO

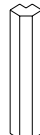

Corner Post
30mm (L) x 30mm (W)
x 720mm (H)

EXS PTO



MTM Corner Post
715mm (150 x 150mm Max)

MTM

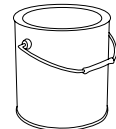

Touch Up Paint
Available 30ml or 1 Litre volumes.

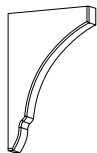

Shelf Bracket
100mm (L) x 18mm (W)
x 150mm (H)

EXS PTO

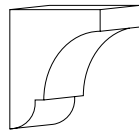

Corbel
125mm (L) x 90mm (W)
x 165mm (H)

EXS PTO



French Mantle Corbel
350mm (L) x 90mm (W)
x 600mm (H)

EXS PTO

Available Primed Ex. Stock Only.

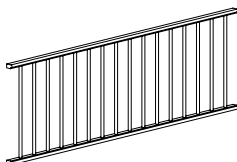
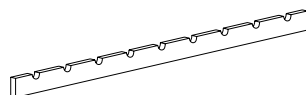

Plate Cot (Pair) /
1000mm (L) x 23mm (W) x 308mm (H)

EXS PTO



Wine Rack Rail
1200mm (L) x 18mm (W) x 60mm (H)

EXS PTO

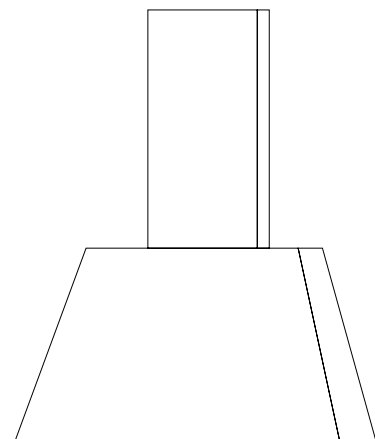

Chimney Canopy
900mm (W) x 400mm (D) x 1130mm (H)

PTO

Hyde | Accessories

Panel	Size MM	Unfinished Ex.Stock*	Painted To Order	Unfinished MTM*	Painted MTM
Plain Panel	18mm / 785 x 360mm	●	●	●	●
Plain Panel	18mm / 900 x 360mm	●	●	●	●
Plain Panel	18mm / 900x 650mm	●	●	●	●
Plain Panel	18mm / 900 x 864mm	●	●	●	●
Plain Panel	18mm / 900 x 1160mm	●	●	●	●
Plain Panel	18mm / 900 x 1200mm	●	●	●	●
Plain Panel	18mm / 965 x 360mm	●	●	●	●
Plain Panel	18mm / 2400 x 360mm	●	●	●	●
Plain Panel	18mm / 2400x 650mm	●	●	●	●
Plain Panel	18mm / 2400x 900mm	●	●	●	●
Plain Panel	Made to Measure per m2	×	●	●	●
T&G Panel	Made to Measure per m2	×	●	●	●

*Unfinished Ex.Stock - These items will be supplied as raw MDF.
 *Unfinished MTM - These items will be supplied as raw MDF.



Plain Panel / 18mm Thick

EXS PTO MTM

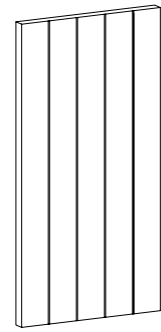

T&G Panel / 18mm Thick

MTM

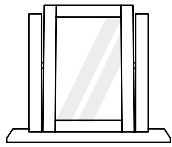

Single Square Mirror
485mm (W) x 570mm (H)

EXS PTO

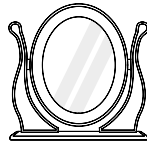

Single Oval Mirror
485mm (W) x 570mm (H)

EXS PTO



Headboard
MTM per m2. / Supplied as a flat panel

MTM

Painted | Curved Door Specifications

MDF Matt / Gloss Painted Curved Door Specification

Arena / Parker / Tenby / Belair /
Hyde / Hartford

MDF Painted Curved Doors are made to suit
300mm x 300mm cabinets only.

Height availability ranges from 570mm up to 2250mm.

Luzzi Curved Doors only available at 715mm High.

MDF Concave Doors are not available.

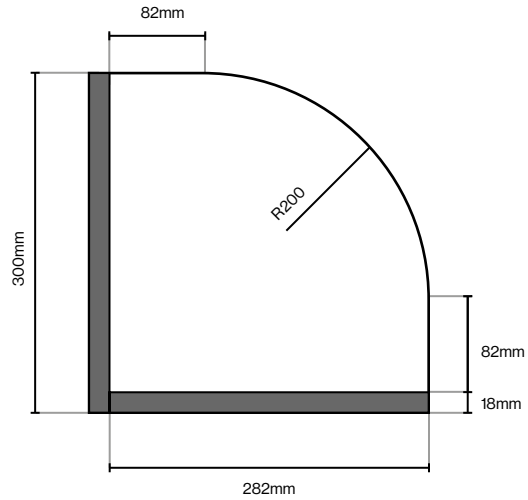

Solid Timber Painted Curved Door Specification

Edison / Monroe / Albany /
Hampton / Greenwich Ash /
Greenwich Oak

Solid Timber Curved Doors are made to suit
300mm x 300mm cabinets only. Height
availability 715mm ONLY.

Solid Timber Concave Doors are not available.

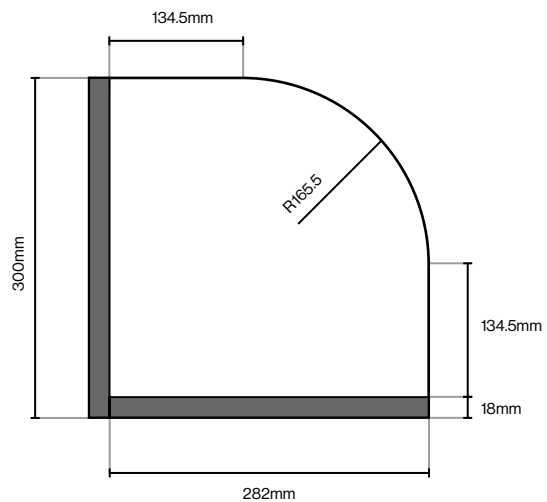

Painted | Moulding Specifications

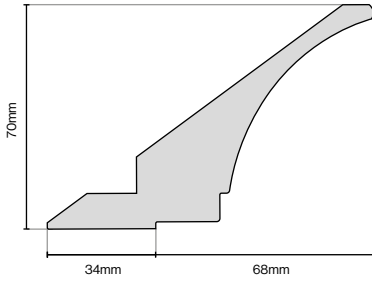

Classic Cornice (Smooth)
3050mm Lengths

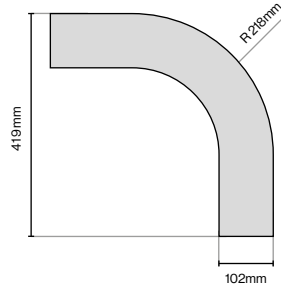

Curved Classic Cornice (Smooth)
419mm (L) x 419mm (W) x 70mm (H)

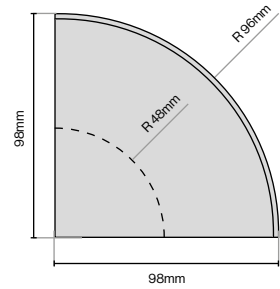

Classic Cornice Quadrant (Smooth)
98mm (L) x 98mm (W) x 70mm (H)

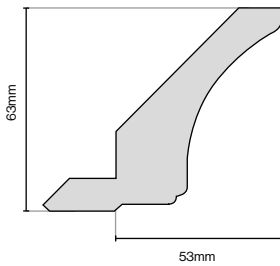

Classic Cornice (Grained)
3050mm Lengths

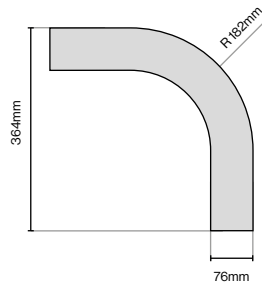

Curved Classic Cornice (Grained)
364mm (L) x 364mm (W) x 63mm (H)

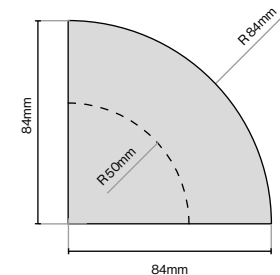

Classic Cornice Quadrant (Grained)
84mm (L) x 84mm (W) x 63mm (H)

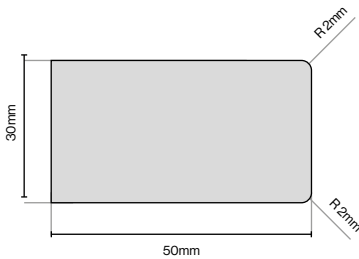

Modern Cornice / Pelmet
3050mm Lengths

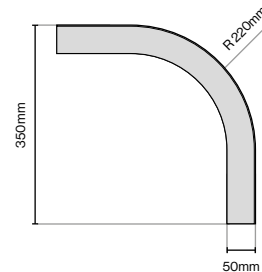

Curved Modern Cornice / Pelmet
350mm (L) x 350mm (W) x 30mm (H)

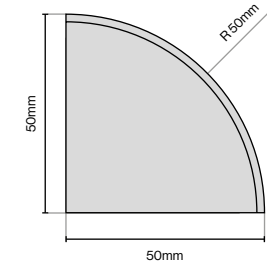

Modern Cornice / Pelmet Quadrant
50mm (L) x 50mm (W) x 30mm (H)

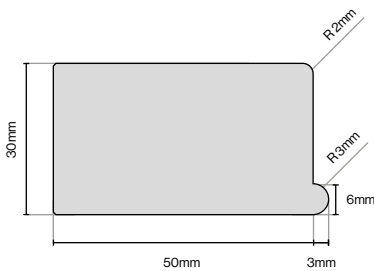

Under Cornice (Smooth)
3050mm Lengths

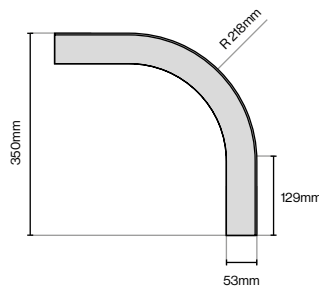

Curved Under Cornice (Smooth)
350mm (L) x 350mm (W) x 30mm (H)

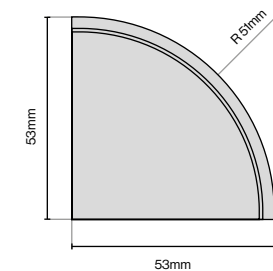

Under Cornice Quadrant (Smooth)
53mm (L) x 53mm (W) x 30mm (H)

Painted | Moulding Specifications

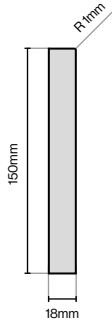

Plain Plinth
MDF - 3050mm Lengths
Solid Ash Timber - 2850mm Lengths
Solid Oak Timber - 2440mm Lengths

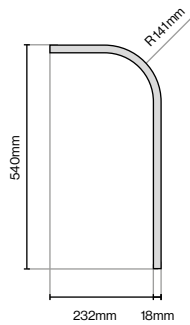

Curved Plain Plinth
540mm (L) x 250mm (W) x 150mm (H)

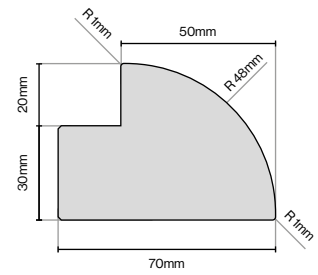

Radius Profile
3050mm Lengths

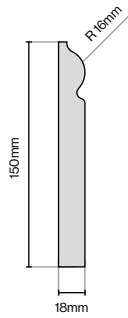

Torus Plinth
3050mm Lengths

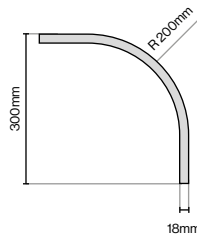

Curved Torus Plinth (Smooth)
300mm (L) x 300mm (W) x 150mm (H)

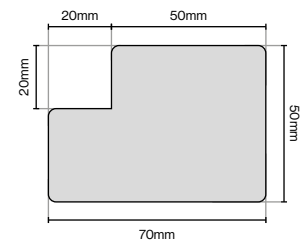

Square Pilaster
3050mm Lengths

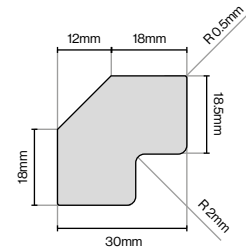

Corner Post
3050mm Lengths

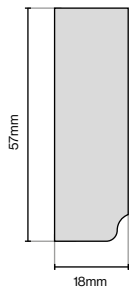

Tangent Light Pelmet
3050mm Lengths

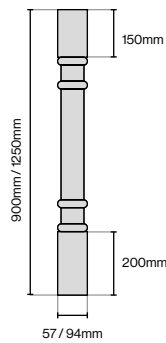

Turned Pilaster (Solid Timber)
900mm (H) x 94mm (W)
900mm (H) x 57mm (W)
1250mm (H) x 57mm (W)

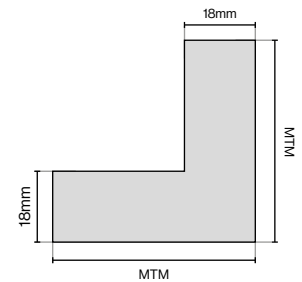

MTM Corner Post
715mm (150mm x 150mm Max)

Painted | Moulding Specifications

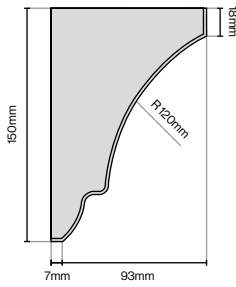

Shelf Bracket
100mm (L) x 18mm (W) x 150mm (H)

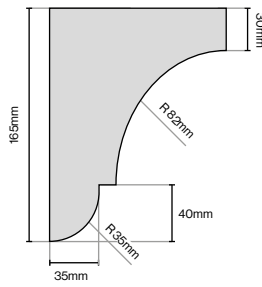

Classic Corbel
125mm (L) x 90mm (W) x 165mm (H)

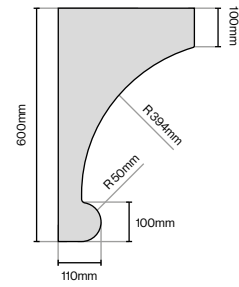

French Mantle Corbel
350mm (L) x 90mm (H) x 600mm (H)

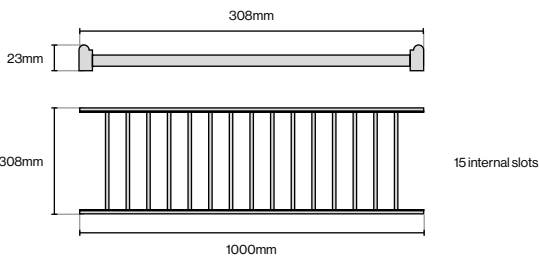
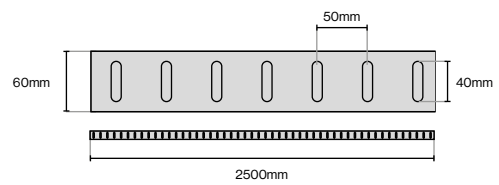
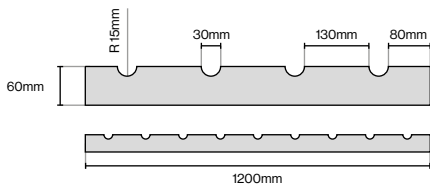

Plate Cot
1000mm (L) x 23mm (W) x 308mm (H)



Fluted Rail
2500mm Lengths



Wine Rack Rail
1200mm (L) x 18mm (W) x 60mm (H)

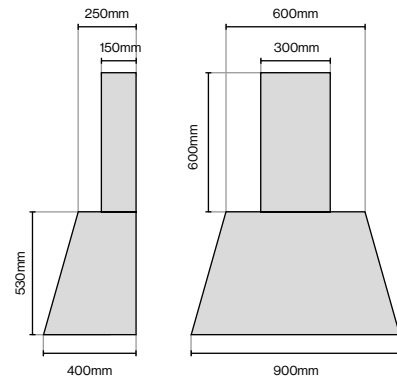

Chimney Canopy
900mm (W) x 400mm (D) x 1130mm (H)

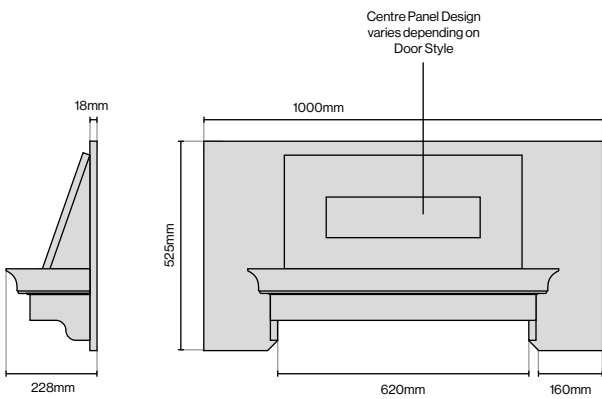

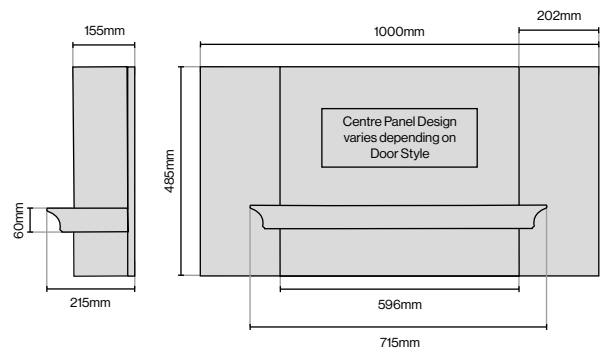

Modern Canopy
1000mm (W) x 228mm (D) x 525mm (H)

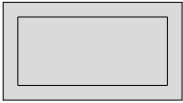
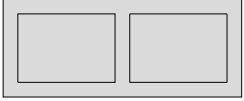
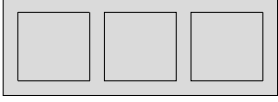
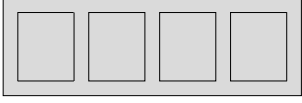

Classic Canopy
1000mm (W) x 215mm (D) x 485mm (H)

Painted | Bedroom Accessories Specifications

Painted Headboard Specifications			
Headboard Type	Height Range MM	Height Range MM	Applicable Door Styles
Single Panel 	500mm – 900mm	915mm – 1830mm	Hartford
2 Panel 	500mm – 900mm	915mm – 1830mm	Hartford
3 Panel 	500mm – 900mm	1371mm – 1830mm	Hartford
4 Panel 	500mm – 900mm	1510mm – 1830mm	Hartford
Flat Panel 	500mm – 900mm	915mm – 1830mm	Arena, Tenby, Belair, Hyde and Hartford

Headboards: All Headboards are supplied rectangular using the design of door style ordered.
 All Headboards will be supplied as Single Panels / Flat Panels (Applicable to Door Style) as standard, unless otherwise specified (Door Design permitting).

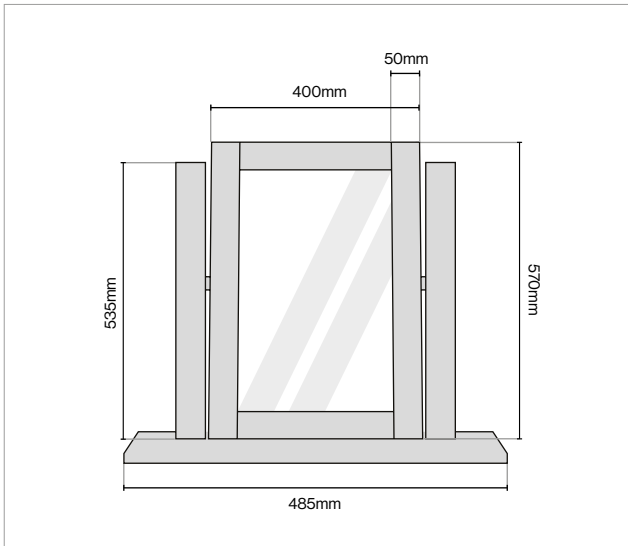



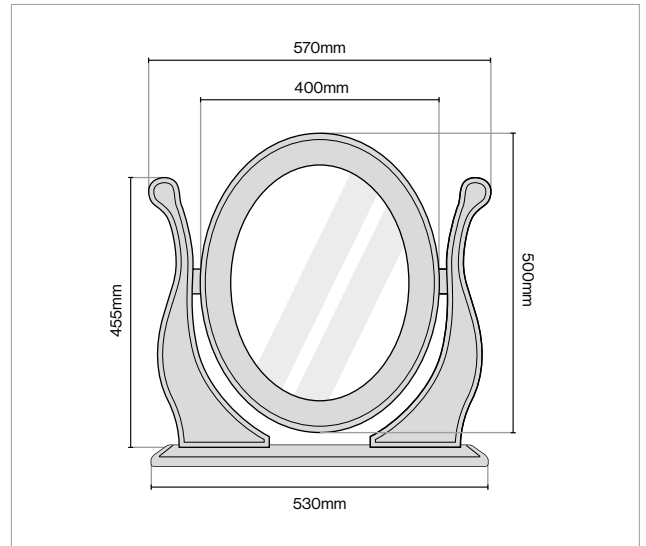





























Single Square Mirror: Single Square Mirrors are supplied fully assembled.



Oval Mirror: Oval Mirrors are supplied fully assembled.

Painted | RAL Colour Match References

RAL Colour Match References	
O&S Doors Paint Colour	RAL Colour Match
 White	RAL 9003
 Ivory	RAL 100 90 10
 Porcelano	RAL 110 90 05
 Mussel	RAL 095 80 10
 Pebble	RAL 080 70 05
 Dakar	RAL 090 70 10
 Taupe Grey	RAL 080 80 05
 Cashmere	RAL 080 80 05
 Stone Grey	RAL 060 60 05
 Honeycomb	RAL 080 70 40
 French Lavender	RAL 320 50 05
 French Chalk	RAL 050 85 01
 Heritage Pink	RAL 030 70 10
 Foraged Fruit	RAL 320 20 10
 Heritage Red	RAL 010 30 20
 Sea Breeze	RAL 160 70 05
 Sage	RAL 100 70 10
 Moss Green	RAL 120 60 10
 Liberty Green	RAL 180 50 10
 Heritage Green	RAL 180 40 05
 Conifer	RAL 160 30 05
 Nautical	RAL 230 20 15
 Light Blue	RAL 140 70 05
 Denim	RAL 250 70 10
 Eiffel Blue	RAL 260 40 20
 Marine Blue	RAL 260 20 15
 Indigo	RAL 280 20 05
 Highland Grey	RAL 000 90 00
 Light Grey	RAL 7035

RAL Colour Match References	
O&S Doors Paint Colour	RAL Colour Match
 Dust Grey	RAL 000 60 00
 Graphite	RAL 000 30 00
 Carbon Black	RAL 000 15 00

Important Notice: These RAL Colour match references are suggested options only. They are the closest RAL colour match to our paint colour, but please note they are not exact matches. Customers are strongly advised to obtain paint swatch samples to confirm a satisfactory colour match.

O&S Doors Ltd do not accept responsibility for any subsequent dissatisfaction between our paint colours and externally sourced paint colour matches. The listed RAL Colour matches are correct at time of printing. Due to unforeseen changes to the supply chain O&S Doors Ltd reserve the right due to amend, alter or discontinue paint finishes without prior notice.

For closest colour match we recommend using paint supplied by O&S Doors Ltd.

Please note whilst every effort is made to manufacture painted products to a consistently high standard, there may be variations in the actual finish in certain circumstances. Samples are offered as a reference guide only and may be subject to slight variations.

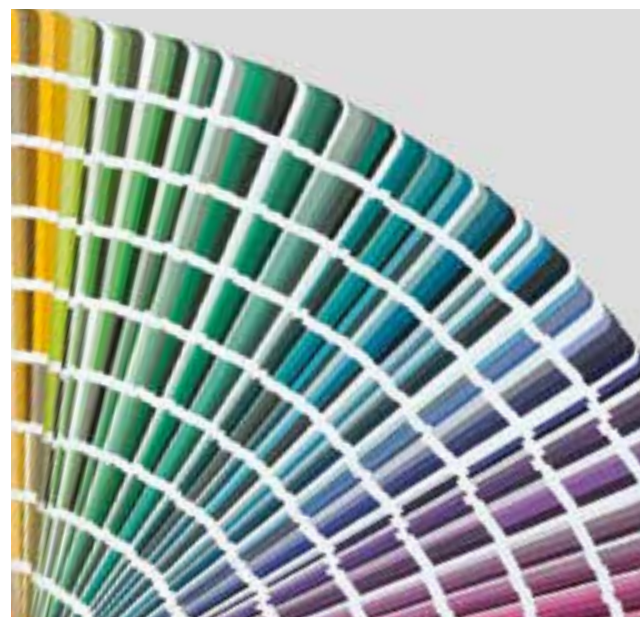

Heat Deflectors | Profiles and Technical Specifications



Heat Deflectors		
Product Code	Area Needed	Pack Includes
HEATDEFLECT BU 18MM	Built Under Oven	- 2 x side heat deflectors / 603mm (L)
HEATDEFLECT DO 18MM	Double Oven	- 2 x side heat deflectors / 898mm (L) - 1 x lower heat deflector / 596mm (L)
HEATDEFLECT SO 18MM	Single Oven	- 2 x side heat deflectors / 634mm (L) - 1 x lower heat deflector / 596mm (L)

All Heat Deflector sizes shown above are made to suit 18mm board thickness. For double under oven use HDS02 Double Oven and trim to size.

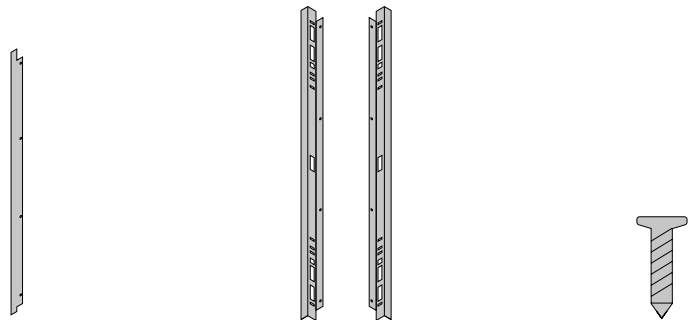

Lower Heat Deflector

Left and Right Side Heat Deflectors

12mm Screws

Assembly Guide

Before you start, check the pack to make sure all the components are included. If not please call our customer services team on 028 3754 9190.

Step 1: Position the left side heat deflector as shown in figure 1 and align with the top edge of the oven aperture. Mark the screw positions with a bradawl and secure using the 12mm screws provided.

Step 2: Repeat for the right side heat deflector.

Step 3: Position the lower heat deflector as shown in figure 2. Mark the screw positions with a bradawl and secure using the 12mm screws provided.

Important Note:

Cut outs are provided in the heat deflector to allow your oven to be fixed to the cabinet once the heat deflectors are in place. If the fixing positions for your oven do not align with any of the standard cut outs, drill through the heat deflector using a suitable metal drill bit. Please note that with some models of oven it may be necessary to omit fitting the lower heat deflector to allow the oven door to open correctly.

Care and Maintenance:

- Wipe clean regularly with a soft damp cloth.
- More stubborn marks can be removed with a soft damp cloth using mild detergents.
- DO NOT use corrosive or abrasive cleaners, which may damage the protective coating of the heat deflectors.

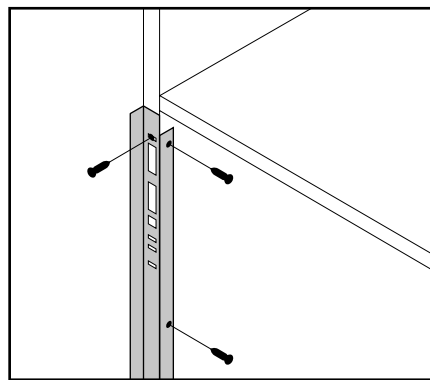

Figure 1 / Side Heat Deflector Assembly

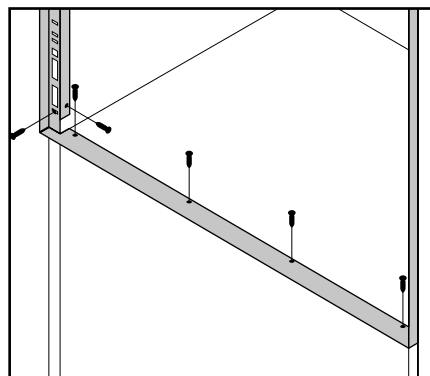

Figure 2 / Lower Heat Deflector Assembly

Carefully Curated. Durably Designed. Beautifully Built. **Handle Accessories**

Add the finishing touch to your cabinet design with our wide range of Handle components. With various styles including Bar, Cup, Scoop, Bow, Knobs and 'D' Handles. We have multiple finishes available, from rustic brushed nickel to modern chrome, there's a handle to suit every type of Kitchen, Bedroom and Bathroom.



Standard Handles
Page 228



Integrated Handles
Page 232

Standard Handles | Black | Satin Brass | Brushed Nickel

Oxford Knob

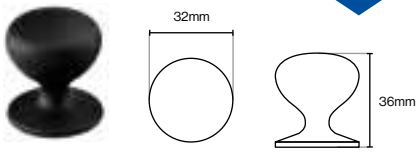

Code	Length	Hole Centre
129	32mm	16mm (Single)

Oxford Knob

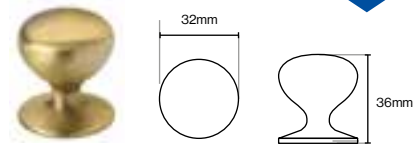

Code	Length	Hole Centre
121	144mm	128mm (Double)

Oxford Knob

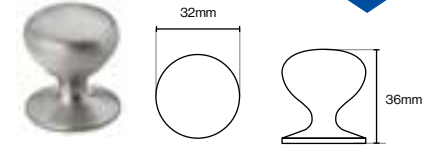

Code	Length	Hole Centre
125	32mm	16mm (Single)

Oxford Cup

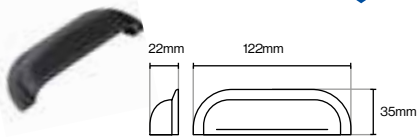

Code	Length	Hole Centre
130	122mm	96mm (Double)

Oxford Cup

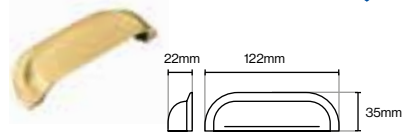

Code	Length	Hole Centre
123	144mm	128mm (Double)

Oxford Cup

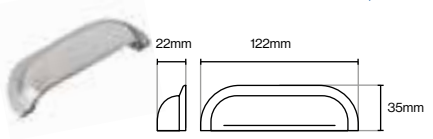

Code	Length	Hole Centre
127	122mm	96mm (Double)

Fender Knurled Knob

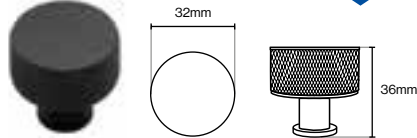

Code	Length	Hole Centre
132	30mm	15mm (Single)

Fender Knurled Knob

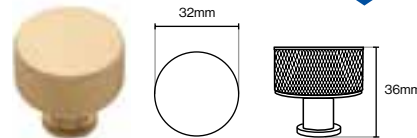

Code	Length	Hole Centre
133	30mm	15mm (Single)

Camden Cup

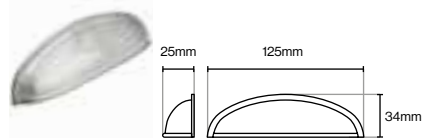

Code	Length	Hole Centre
097	125mm	96mm (Double)

Fender Knurled 'D' Handle

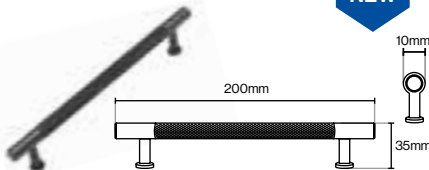

Code	Length	Hole Centre
134	200mm	160mm (Double)

Fender Knurled 'D' Handle

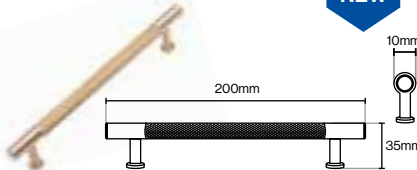

Code	Length	Hole Centre
135	200mm	160mm (Double)

Camden 'D' Handle

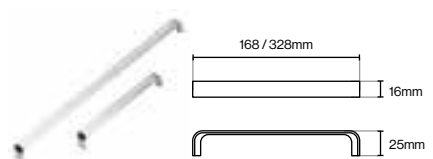

Code	Length	Hole Centre
105	168mm	160mm (Double)
101	328mm	320mm (Double)

Hampton 'D' Handle

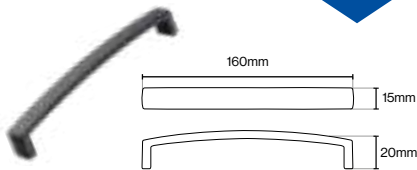

Code	Length	Hole Centre
136	160mm	160mm (Double)

Flat 'D' Handle

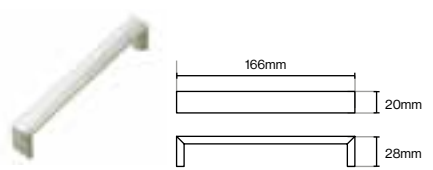

Code	Length	Hole Centre
066	166mm	160mm (Double)

Standard Handles | Chrome | Bronze | Antique Copper | Pewter

Oxford Knob

NEW

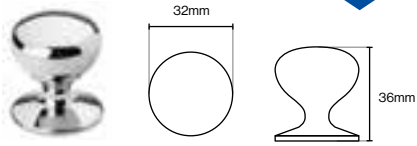

Code	Length	Hole Centre
126	32mm	16mm (Single)

Oxford Knob

NEW

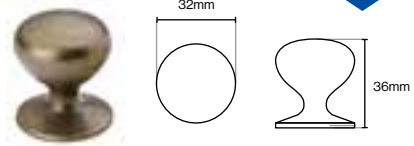

Code	Length	Hole Centre
122	144mm	128mm (Double)

Finsbury 'D' Handle

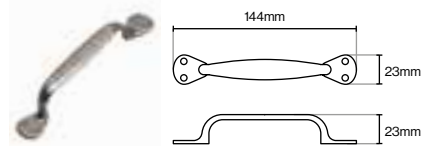

Code	Length	Hole Centre
119	144mm	96mm (Double)

Oxford Cup

NEW

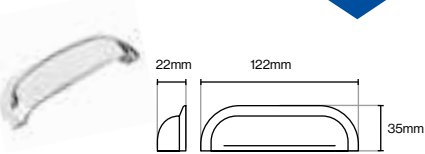

Code	Length	Hole Centre
128	122mm	96mm (Double)

Oxford Cup

NEW

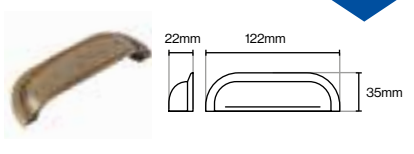

Code	Length	Hole Centre
124	144mm	128mm (Double)

Finsbury Cup

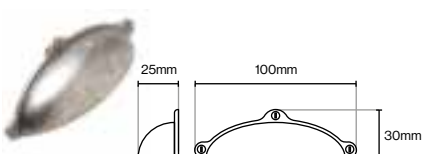

Code	Length	Hole Centre
120	100mm	64mm (Double)

Camden Cup

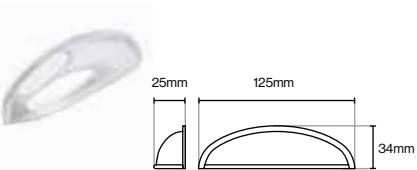

Code	Length	Hole Centre
098	125mm	96mm (Double)

Camden Cup

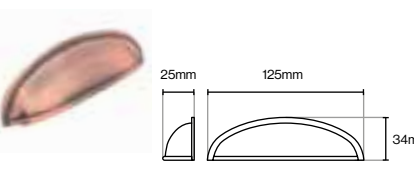

Code	Length	Hole Centre
096	125mm	96mm (Double)

Camden Cup

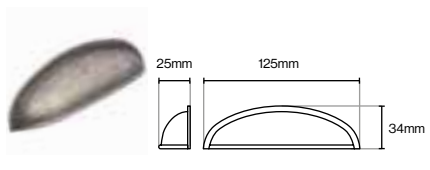

Code	Length	Hole Centre
099	125mm	96mm (Double)

Camden 'D' Handle

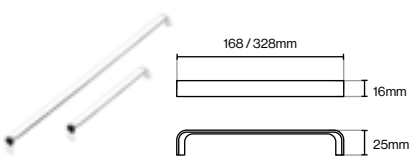

Code	Length	Hole Centre
106	168mm	160mm (Double)
102	328mm	320mm (Double)

Camden 'D' Handle

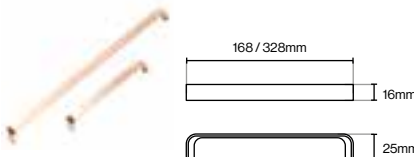

Code	Length	Hole Centre
104	168mm	160mm (Double)
100	328mm	320mm (Double)

Camden 'D' Handle

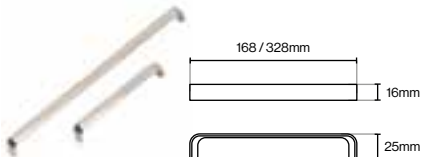

Code	Length	Hole Centre
107	168mm	160mm (Double)
103	328mm	320mm (Double)

Levi 'D' Handle

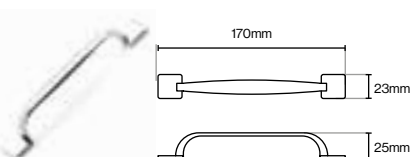

Code	Length	Hole Centre
118	170mm	128mm (Double)

(While Stock Lasts)

Standard Handles | Chrome | Brushed Nickel | Wood

Windsor 'D' Handle

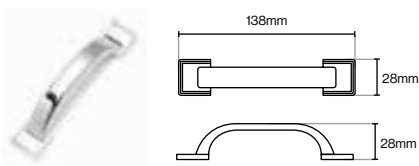

Code	Length	Hole Centre
095	138mm	96mm (Double)

'D' Handle

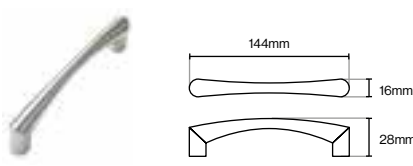

Code	Length	Hole Centre
002	144mm	128mm (Double)

Beech Knob

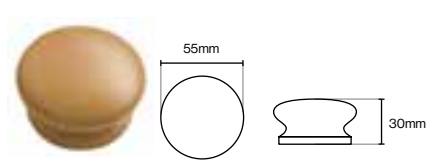

Code	Length	Hole Centre
057	55mm	27.5mm (Single)

While Stock Lasts

Windsor Modern Cup

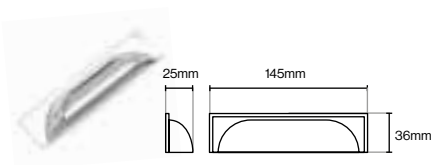

Code	Length	Hole Centre
080	145mm	96mm (Double)

Aries Steel Bar Handle

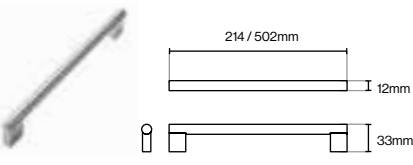

Code	Length	Hole Centre
003 (214)	214mm	198mm (Double)
003 (502)	502mm	486mm (Double)

Scoop Integrated Handle

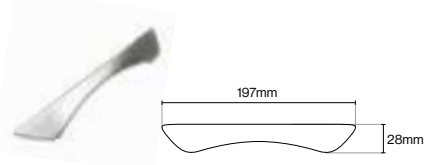

Code	Length	Hole Centre
010	197mm	160mm (Double)

Beam Handle

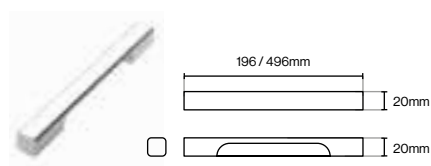

Code	Length	Hole Centre
076	196mm	160mm (Double)

Letterbox Handle

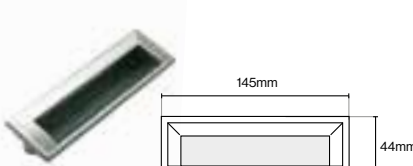

Code	Length	Hole Centre
020	145mm	128mm (Double)

New Handle | Hampton 'D' Handle



Hampton 'D' Handle

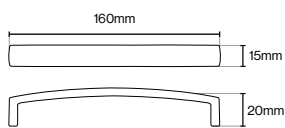

Code	Length	Hole Centre
136	160mm	160mm (Double)

Integrated Handles | Handle Accessories



Zenith is Compatible with our Edged Collection.

Please note an additional door rebate cost is incurred when ordering the Zenith Handle along with Phoenix, Tribeca, Vaasa or Mather Doors.

It is important to specify that you want to include the rebate when ordering. This will ensure your order is processed correctly.

Zenith Handleless Rebate Door - Priced as door size plus 7.5%. See page 90 for applicable Door Ranges.

Zenith Integrated Handle Range

Code	Length MM	Finish
094	146mm	Brushed Nickel
094	278mm	Brushed Nickel
094	296mm	Brushed Nickel
094	308mm	Brushed Nickel
094	313mm	Brushed Nickel
094	346mm	Brushed Nickel
094	396mm	Brushed Nickel
094	446mm	Brushed Nickel
094	496mm	Brushed Nickel
094	546mm	Brushed Nickel
094	596mm	Brushed Nickel
094	796mm	Brushed Nickel
094	896mm	Brushed Nickel
094	996mm	Brushed Nickel
094	1196mm	Brushed Nickel

Door Size Guidance

Please be aware the top section of the Zenith Handle will add 3mm to the height of your door size, so therefore you must allow space on your cabinet height to allow for this additional 3mm, or else decrease the height of your door size by 3mm when ordering MTM.

Nominal Sizes Shown

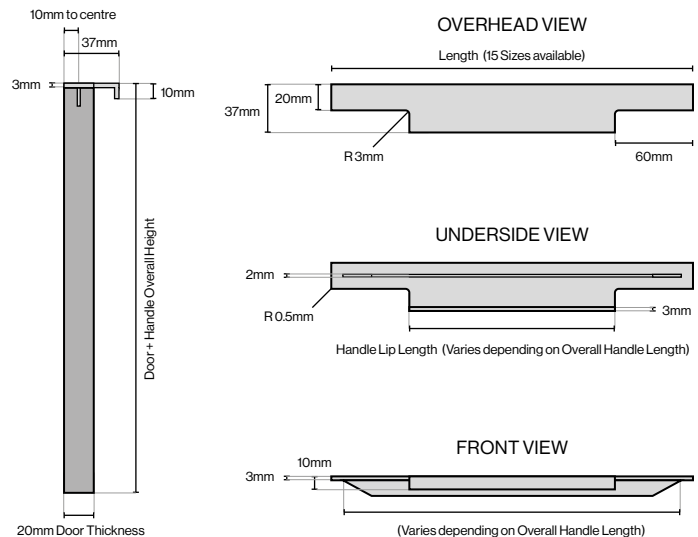

Integrated Handles | Handle Accessories



Scoop Integrated Handle

Code	Length	Hole Centre	Finish
010	197mm	160mm (Double)	Satin Chrome

Applicable Door Styles - 5G Vinyl Seymour Door Style - See page 16.

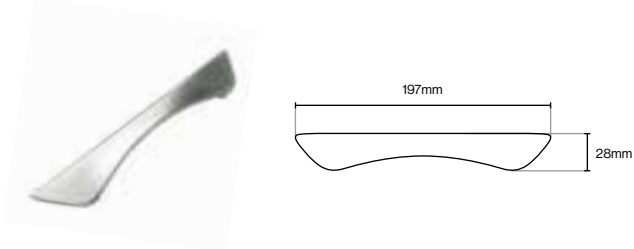

Letterbox Integrated Handle

Code	Length	Hole Centre	Finish
020	145mm	128mm (Double)	Satin Chrome

Applicable Door Styles - 5G Vinyl Frankfurt Door Style - See page 16.

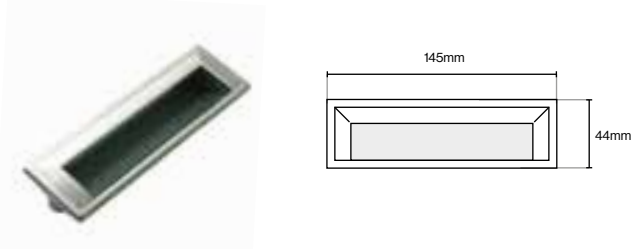

Door Matrix | Standard Kitchen Door Configurations

- Standard Kitchen dimensions shown are based on 40mm thick worktops.
- All dimensions shown are in millimetres.
- All dimensions shown refer to door frontal sizes unless otherwise stated.
- Refer to individual range pages for definitive list of door sizes available.
- In relation to appliances, follow the manufacturer's installation instructions carefully, particularly for hob to extractor / hood distances and ventilation. Allow proper clearances and ventilation below and behind the appliance (typically 50mm high / deep).
- All appliance units shown are based on 600mm wide. Dimensions shown in brackets refer to appliance aperture heights (the overall distance between door frontals).
- To reduce an aperture to the exact size, cut trimmer panels from a 596mm wide door. The appliance shelf position must be correctly calculated to ensure appropriate appliance door positioning.
- Allow gaps between the appliance and cabinet doors. These are typically 3mm between horizontally adjacent cabinet door frontals and 5mm between vertically adjacent cabinet door frontals.

1825mm / Base and Wall Unit Door Configurations

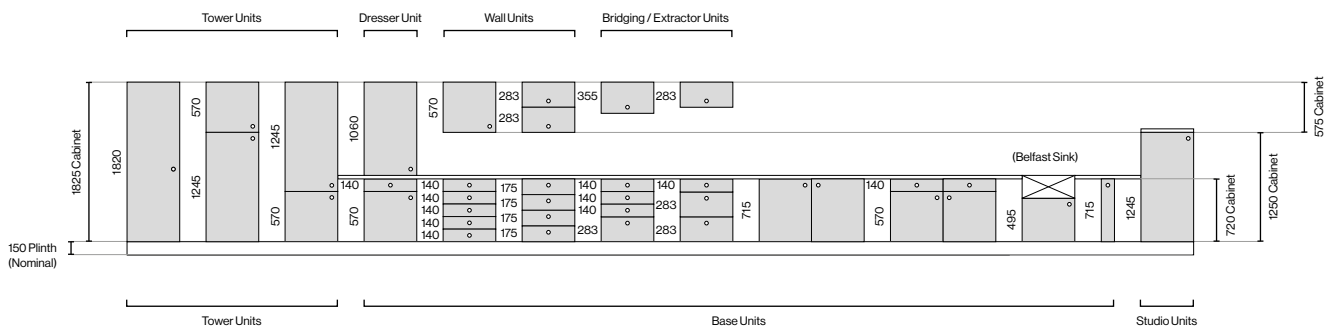

1970mm / Base and Wall Unit Door Configurations

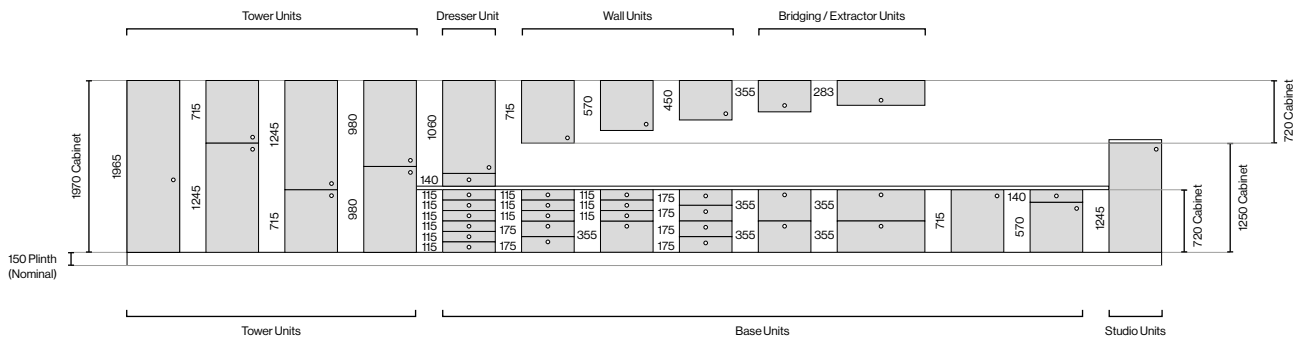

2150mm / Base and Wall Unit Door Configurations

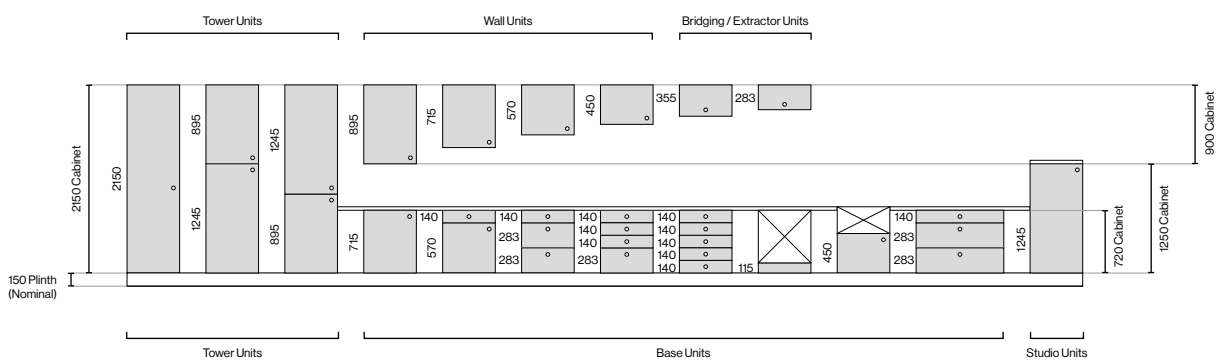

Door Matrix | Standard Kitchen Door Configurations

1250mm / Studio Height Unit Door and Appliance Configurations

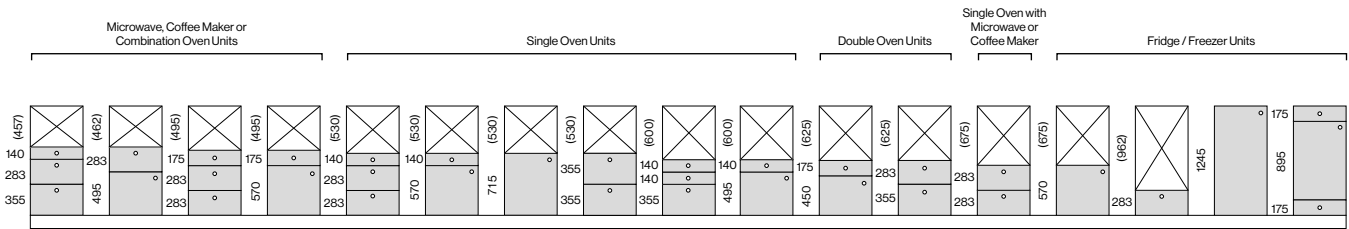

1825mm / Full Height Unit Door and Appliance Configurations

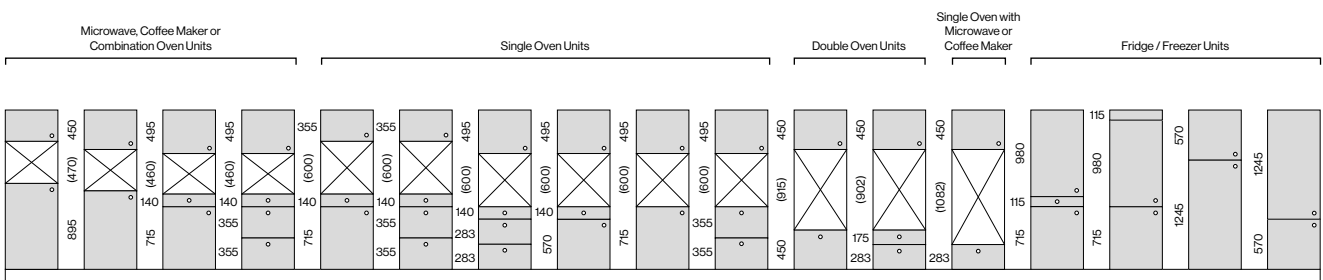

1970mm / Full Height Unit Door and Appliance Configurations

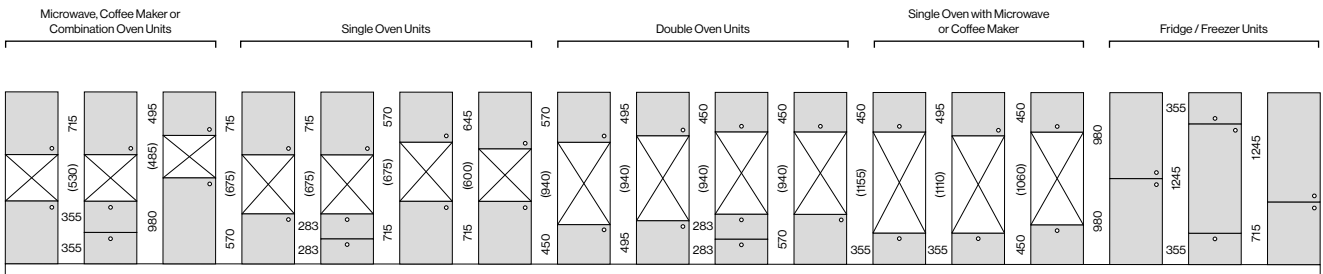

2150mm / Full Height Unit Door and Appliance Configurations

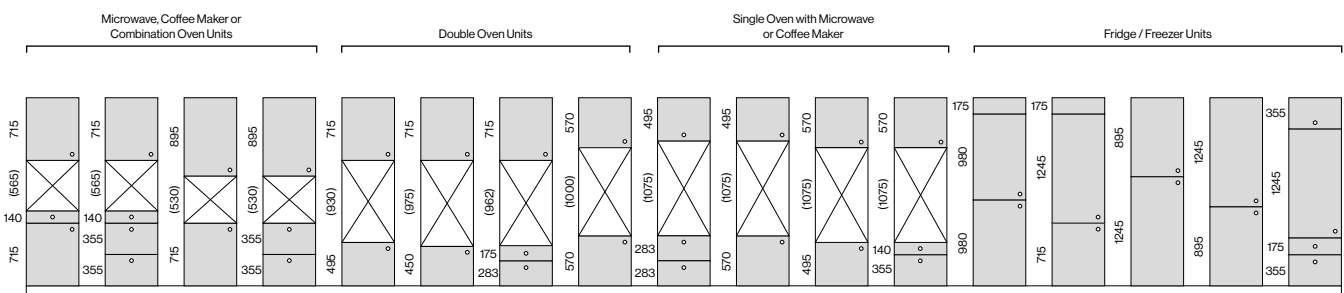

Door Matrix | Handleless Rail Kitchen Door Configurations

- All appliance units shown are based on 600mm wide. Dimensions shown in brackets refer to appliance aperture heights (the overall distance between door frontals).
- To reduce an aperture to the exact size, cut trimmer panels from a 596mm wide door. The appliance shelf position must be correctly calculated to ensure appropriate appliance door positioning.
- Allow gaps between the appliance and cabinet doors. These are typically 3mm between horizontally adjacent cabinet door frontals and 5mm between vertically adjacent cabinet door frontals.
- In relation to appliances, follow the manufacturer's installation instructions carefully, particularly for hob to extractor / hood distances and ventilation. Allow proper clearances and ventilation below and behind the appliance (typically 50mm high / deep).
- Refer to individual range pages for a definitive list of door sizes available.

1970mm / 2150mm / Base and Wall Unit Door Configurations

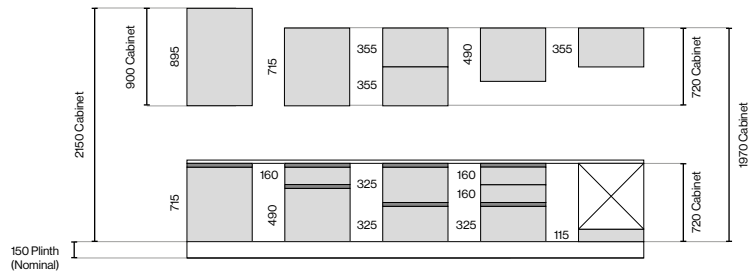

1250mm / Studio Height Unit Door and Appliance Configurations

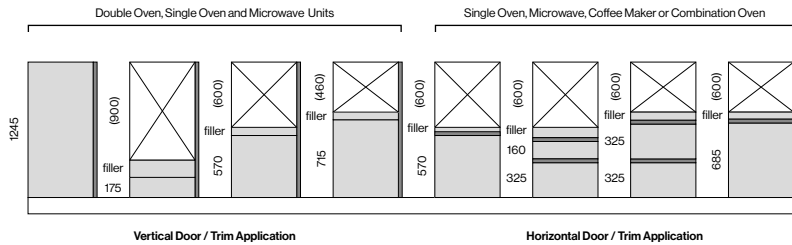

1970mm / Full Height Unit Door and Appliance Configurations

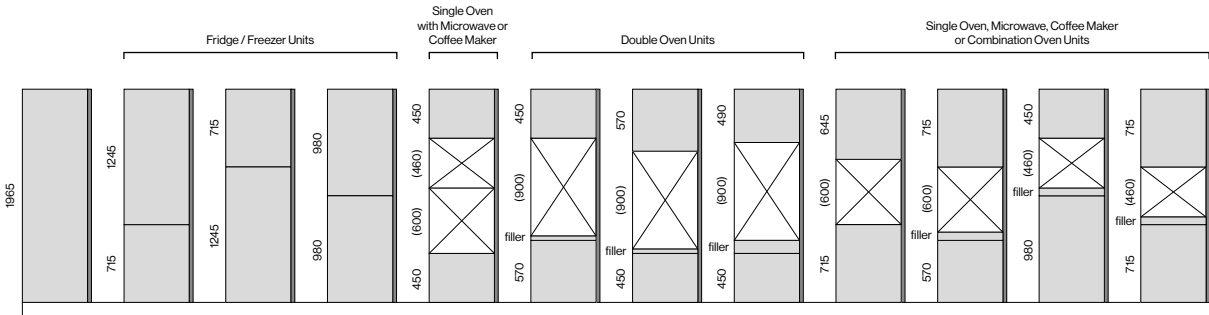

2150mm / Full Height Unit Door and Appliance Configurations

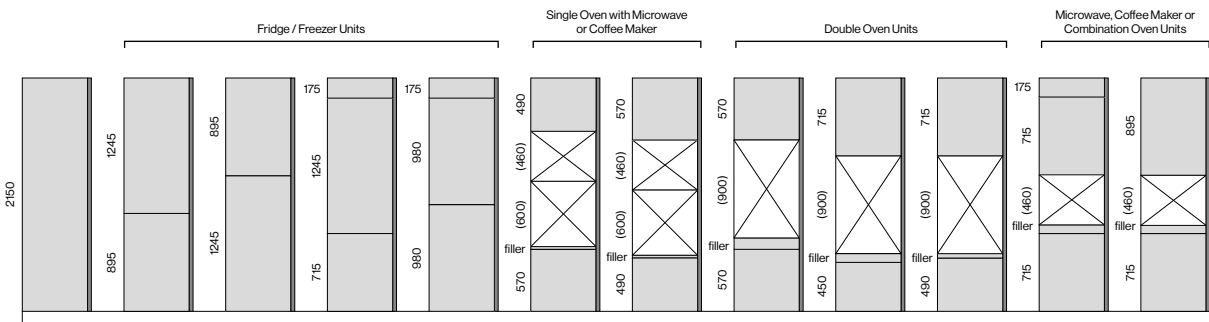

Door Matrix | Bedroom Door Configurations

- All dimensions shown are in millimetres.
- All dimensions shown refer to door frontal sizes unless otherwise stated.
- Refer to individual range pages for definitive list of door sizes available.

Standard Bedroom / 2150mm / 2250mm / Base and Full Height Unit Door Configurations

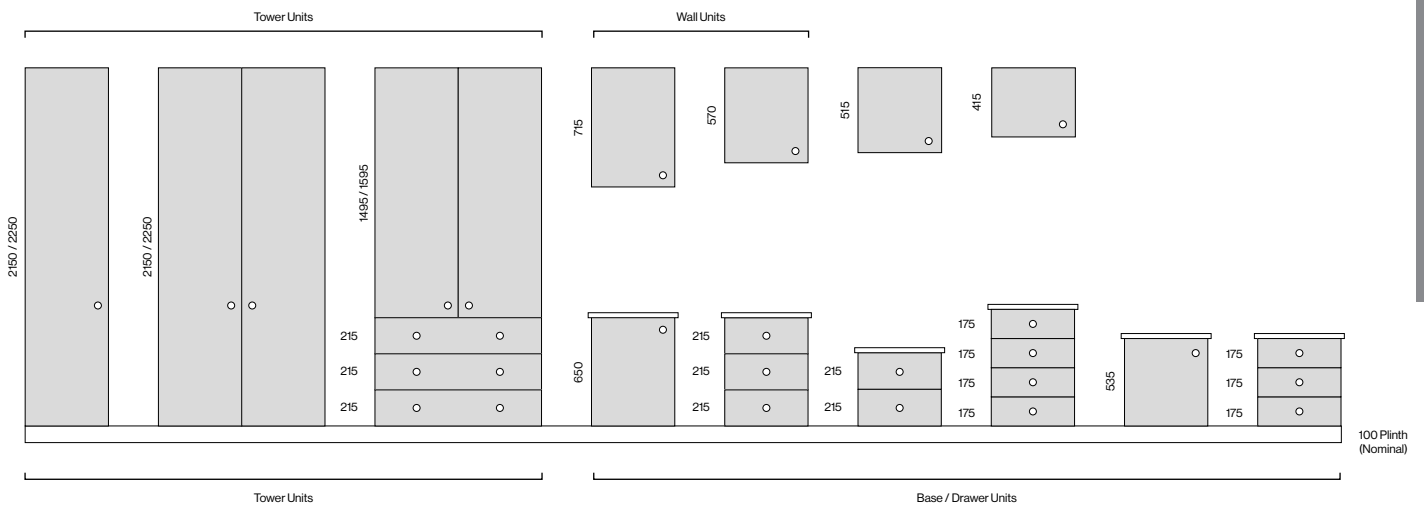

Handleless Rail Bedroom / 2150mm / 2250mm / Base and Full Height Unit Door Configurations

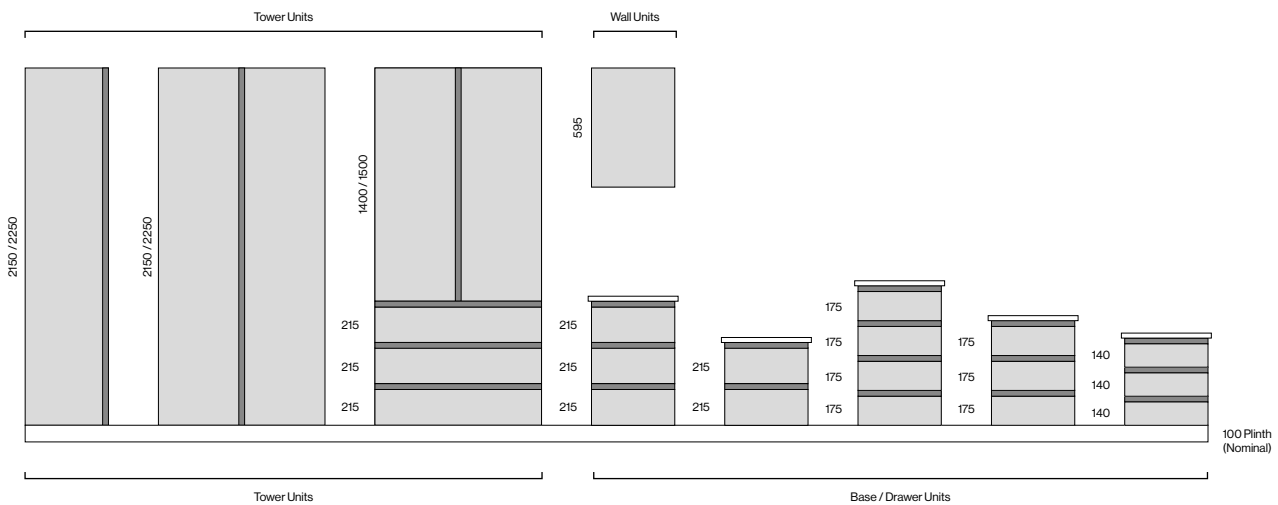

Order Form | Doors, Accessories and Components

Please fill in all necessary details to ensure your order is processed correctly and avoid any discrepancies.

1/2

Company Name		PO Number
Telephone	Account Code	Reference
Email Address		Date Required

Please note all deliveries will be made via standard delivery to your company account address. If Special or Express delivery is required please contact our Customer Services team.

Door Style*	
Colour / Finish*	Reverse Colour

*Please note you can only use one Order Form per Door Style and Colour / Finish.

Doors / Drawers / Frames

Qty	Height	Width	Item Description	Drilling**	Drilling Description
				<input type="checkbox"/>	
				<input type="checkbox"/>	
				<input type="checkbox"/>	
				<input type="checkbox"/>	
				<input type="checkbox"/>	
				<input type="checkbox"/>	
				<input type="checkbox"/>	
				<input type="checkbox"/>	
				<input type="checkbox"/>	
				<input type="checkbox"/>	
				<input type="checkbox"/>	
				<input type="checkbox"/>	

**If Drilling is required please tick Drilling box and detail specifications within space provided.

Accessories

Qty	Item Description

Handle Accessories

Qty	Item Description	Code

Order Form | Doors, Accessories and Components

Please fill in all necessary details to ensure your order is processed correctly and avoid any discrepancies.

2/2

Panels / Moulded Tops / MFC / Headboards

Qty	Height	Width	Item Description	Drawing*
				<input type="checkbox"/>
				<input type="checkbox"/>
				<input type="checkbox"/>
				<input type="checkbox"/>
				<input type="checkbox"/>
				<input type="checkbox"/>
				<input type="checkbox"/>
				<input type="checkbox"/>
				<input type="checkbox"/>
				<input type="checkbox"/>
				<input type="checkbox"/>
				<input type="checkbox"/>
				<input type="checkbox"/>
				<input type="checkbox"/>
				<input type="checkbox"/>

Important Notes / Special Instructions / Drawings / Drilling Specifications

Please check your order before signing below

Date Ordered:

Signed:

Order Form | Return Gables Order Form

To order a return gable please fill in the necessary details and dimensions below:

The grain direction will run VERTICALLY along the height dimensions - unless otherwise specified.

Company Name		Order No.
Reference	Colour	

Return Gable

A. Gable Height:

.....

B. Gable Width:

.....

C. Front Width:

.....

D. Return Width:

.....

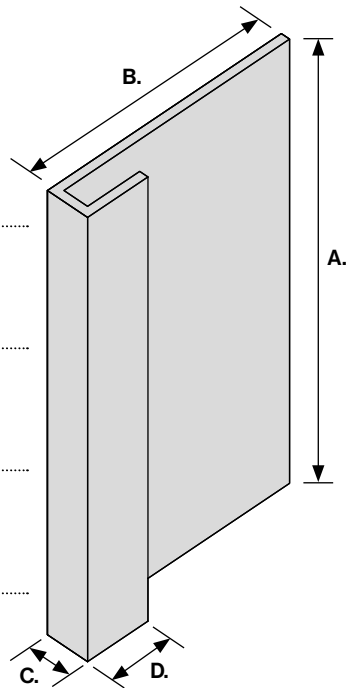

Folded Square Gable

A. Gable Height:

.....

B. Gable Width:

.....

C. Gable Depth:

.....

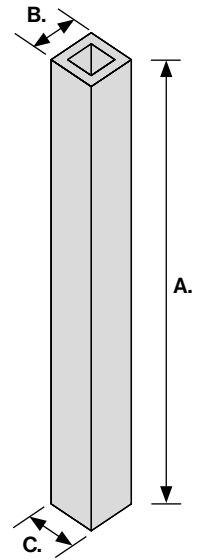

Double Return Gable

A. Gable Height:

.....

B. Gable Width:

.....

C. Front Width:

.....

D. Front Return Width:

.....

E. Rear Width:

.....

F. Rear Return Width:

.....

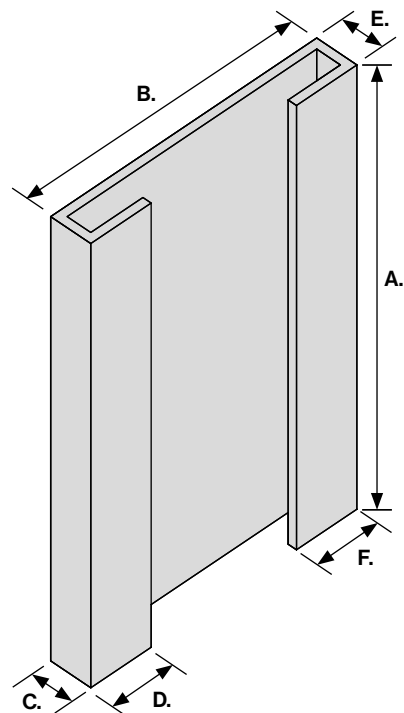

Order Form | Cloaking End Panel Order Form

To order a Cloaking End Panel please fill in the necessary details and dimensions below:

The grain direction will run VERTICALLY along the height dimensions - unless otherwise specified.

Company Name		Order No.
Reference	Colour	

Cloaking End Panel

A. Gable Height:

.....

B. Gable Width:

.....

C. Front Width:

.....

D. Rear Width:

.....

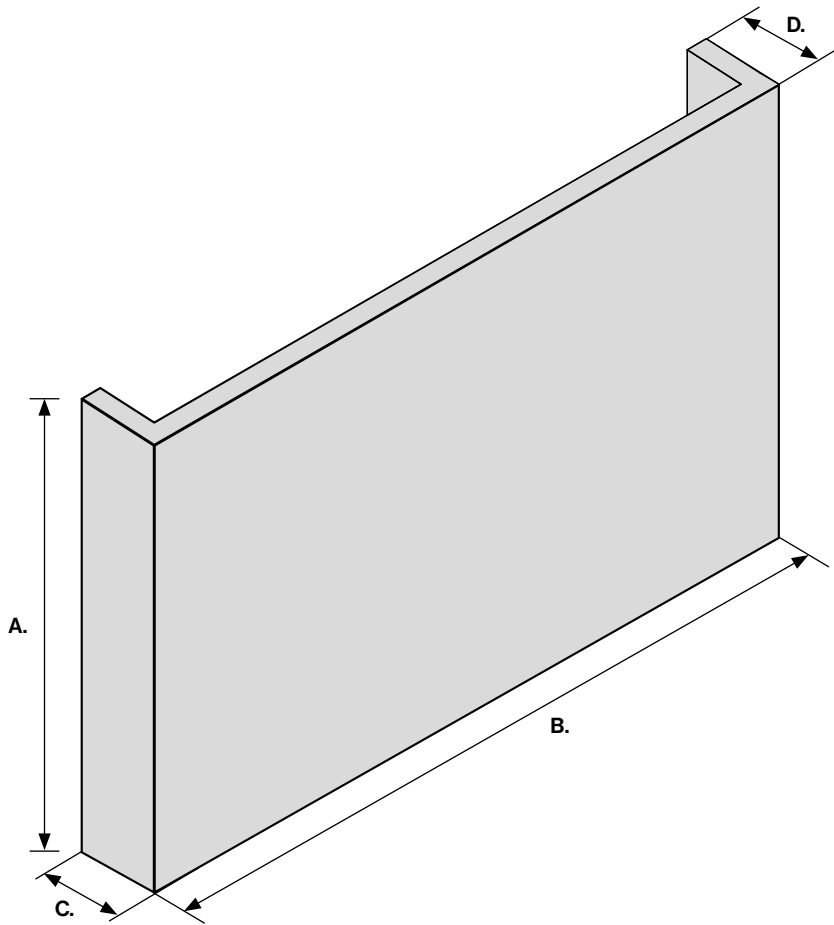

O&S Doors Ltd Terms and Conditions

Definitions

- 1.1 **"Business Day"** means a day (other than a Saturday, Sunday or public holiday) when banks in London are open for business.

"Company" means O & S Doors Limited (company number NIO34182) a company registered in Northern Ireland whose registered office is at 106 Syerla Road, Benburb, Dungannon, Co. Tyrone, BT71 7ET.

"Conditions" means the terms and conditions set out in this document as amended from time to time in accordance with clause 14.5.

"Contract" means any contract between the Company and the Customer for the sale and purchase of the Goods that shall incorporate these Conditions in accordance with clause 2.1.

"Customer" means the person(s), firm or company who purchases the Goods from the Company.

"Force Majeure Event" means an event or circumstance beyond a party's reasonable control.

"Goods" means any kitchen or bedroom doors, panels, associated accessories or any other goods (or any part of them) agreed in the Contract to be supplied to the Customer (including any part or parts of them) and as further detailed in the Order.

"Order" means any order for the Goods accepted by the Company or the Customer's acceptance of the Company's quotation in accordance with clause 2.3, as the case may be.

"O&S Warranty" means the warranty given by the Company to the Customer contained in the Warranty Pack given by the Company to the Customer.

"Specification" means any specification for the Goods, including any related plans or drawings, that are agreed in writing by the Customer and the Company in relation to any bespoke products.

"Warranty Pack" refers to the warranty detailed in Appendix 1 of these Conditions.

Interpretation

- 1.2 In these Conditions references to any statute or statutory provision shall, unless the context otherwise requires, be construed as a reference to that statute or statutory provision as from time to time amended, consolidated, modified, extended, re-enacted or replaced.
- 1.3 In these Conditions any phrase introduced by the terms **including, include, in particular** or any similar expression shall be construed as illustrative and shall not limit the sense of the words preceding those terms.
- 1.4 In these Conditions any reference to **writing** or **written** includes emails but not fax.

Order Process and Basis of Contract

- 2.1 These Conditions apply to each and every Contract to the exclusion of any other terms that the Customer seeks to impose or incorporate, or which are implied by trade, custom, practice or course of dealing. For the avoidance of doubt, no condition of purchase imposed by the Customer shall have any effect in relation to a sale by the Company of Goods unless the Company expressly agrees otherwise in writing.
- 2.2 Each Order (placed by telephone, by fax, by email in writing or by any other means) for Goods shall be subject to these Conditions. The Customer is responsible for ensuring the accuracy of the terms of the Order and, in the case of bespoke Goods, any applicable Specification.
- 2.3 A quotation for the Goods given by the Company shall not constitute an offer. A quotation shall only be valid for a period of 20 Business Days from its date of issue. All quoted prices (whether provided verbally or in writing) are based on the cost of materials, labour, transport and other relevant items relevant at the date when such prices are quoted. However, notwithstanding any such quotation, the Company reserves the right to charge Goods at the price relevant at the date of dispatch, unless the quotation validity period of 20 Business Days has not been exhausted at the date of dispatch.

Any queries regarding prices charged on invoices must be made to the Company in writing within 10 Business Days of the date the Goods were purchased, otherwise they cannot be accepted.

- 2.4 The Goods are made to order. Once an Order is made the manufacturing process is deemed to have commenced immediately. As a result once an Order is made these Conditions will be deemed to have been incorporated, a Contract is created and the Customer is required to accept the Goods in accordance with clause 4.
- 2.5 All tenders, quotations and Orders are subject to supplies being available. Where the Company is unable to fulfil an Order as a result of unavailable supplies the Company shall not take payment for the same and shall not be liable to the Customer for any resulting loss (howsoever it arises).

Description of Goods

- 3.1 Technical specifications, advertising, illustrations, samples, descriptions and diagrams of Goods in the Company's trade literature, catalogue or other published matter (**"Advertising Matter"**) is indicative only of the approximate and general class, character and colour of the Goods. Advertising Matter is approximate only and shall not form part of the Contract. The Company reserves the right to amend the Advertising Matter at its discretion.
- 3.2 Any clerical error or omission in any Advertising Matter, quotation, invoices or any other documents issued by the Company shall be subject to correction without any liability to the Company.
- 3.3 Unless stated otherwise, the dimensions for sawn dimensions are "nominal".
- 3.4 To the extent permitted by law, in no event is any condition made or warranty given by the Company that the Goods will correspond to sample unless specifically agreed to in writing by the Company for any one Contract.
- 3.5 If the Customer requires Goods to comply with any particular Specification it shall inform the Company of such requirements in the Customer's Order. The Company reserves the right to amend the Specification if required by any applicable statutory or regulatory requirements.
- 3.6 To the extent that the Goods are to be manufactured in accordance with a Specification supplied by the Customer, the Customer shall indemnify the Company against all liabilities, costs, expenses, damages and losses (including any direct, indirect or consequential losses, loss of profit, loss of reputation and all interest, penalties and legal and other professional costs and expenses) suffered or incurred by the Company in connection with any claim made against the Company for actual or alleged infringement of a third party's intellectual property rights arising out of or in connection with the Company's use of the Specification. This clause 3.6 shall survive termination of the Contract.

Delivery and Acceptance of the Goods

- 4.1 The Company shall deliver the Goods to the location set out in the Order or such other location as the parties may agree ("Delivery Location") at any time after the Company notifies the Customer that the Goods are ready. The Customer shall be responsible for providing safe, proper, prompt and unhindered access to the Delivery Location to the Company at all reasonable times for unloading and shall be liable for any loss or damage, or cost of delay caused by lack thereof. Where the Customer assists with any unloading it shall be responsible for any damage caused to the Goods arising from Customer's employees acts or omissions.
- 4.2 The Company shall not be liable for any delay in delivery of the Goods that is caused by a Force Majeure Event or the Customer's failure to provide the Company with adequate delivery instructions or any other instructions that are relevant to the supply of the Goods.
- 4.3 The Company may deliver the Goods by separate instalments. The Company may raise a separate invoice and require payment for each instalment. Any delay in delivery or defect in an instalment shall not entitle the Customer to cancel any other instalment.
- 4.4 The Company shall ensure that each delivery of the Goods is accompanied by a delivery note that shows the date of delivery of the Order, all relevant Company reference numbers, the type and quantity of the Goods (including the code number of the Goods, where applicable), special storage instructions (if any) and, if the Goods are being delivered by instalments, the outstanding balance of Goods remaining to be delivered.

- 4.5** Delivery is completed on the completion of unloading of the Goods at the Delivery Location.
- 4.6** If the Company fails to deliver the Goods, its liability shall be limited to the costs and expenses incurred by the Customer in obtaining replacement goods of a similar description and quality in the cheapest market available, less the price of the Goods.
- 4.7** The Customer must inspect the Goods on receipt and mark the delivery note to record any alleged damage in transit. The Customer must within 2 Business Days of receipt of the Goods notify the Company of any alleged defect, shortage in quantity, damage or failure to comply with description by written notification to the Company to be sent to the following email address: orders@osdoors.com
- 4.8** If the Customer fails to comply with the provisions of clause 4.7 the Goods shall be presumed to be in accordance with the Contract and free from any defect or damage which would be apparent on a reasonable examination of the Goods and the Customer shall be deemed to have accepted the Goods. Notwithstanding the terms of the O & S Warranty, after acceptance of the Goods the Customer may not reject the Goods and payment for the same will be payable in accordance with these Conditions.
- 4.9** If the Customer fails to take delivery of the Goods within 3 Business Days of the Company notifying the Customer that the Goods are ready, then, except where such failure or delay is caused by a Force Majeure Event or the Company's failure to comply with its obligations under the Contract:
- 4.9.1** Delivery of the Goods shall be deemed to have been completed at 9.00 am on the fourth Business Day after the day on which the Company notified the Customer that the Goods were ready; and
- 4.9.2** The Company shall store the Goods until delivery takes place, and charge the Customer for all related costs and expenses (including insurance)

Export Sales and Incoterms

- 5.1** Where the Goods are supplied for export from the United Kingdom, the provisions of this clause 5 shall apply notwithstanding any other provision of these Conditions.
- 5.2** Unless the context otherwise requires, any term or expression which is defined in or given a particular meaning by the provisions of Incoterms shall have the same meaning in these Conditions but if there is any conflict between the provisions of Incoterms 2010 and these Conditions, these Conditions shall prevail.
- 5.3** The Customer shall be responsible for complying with any legislation or regulations governing the importation, use or sale of the Goods in the country of destination, the payment of any duties or taxes on them and the transportation and storage of Goods including without limitation any obligation to translate any instructions, labelling or packaging into any other language.
- 5.4** The Company shall be under no obligation to give notice under section 32(3) of the Sale of Goods Act 1979.

Quality and the O&S Warranty

- 6.1** The Company provides the O & S Warranty for all Goods purchased pursuant to these Conditions. Please see the Warranty Pack for further details. The Warranty Pack is designed to set out guidance on how and to whom to report defects and the responsibilities for and terms upon which they will be remedied.

Title and Risk

- 7.1** The risk associated with the Goods shall pass to the Customer on completion of delivery of the Goods.
- 7.2** Title to the Goods shall not pass to the Customer until the Company receives payment in full (in cash or cleared funds) for the Goods and any other goods that the Company has supplied to the Customer in respect of which payment has become due, in which case title to the Goods shall pass at the time of payment of all such sums.

- 7.3** Until title to the Goods has passed to the Customer, the Customer shall:
- 7.3.1** Store the Goods separately from all other goods held by the Customer so that they remain readily identifiable as the Company's property;
- 7.3.2** Not remove, deface or obscure any identifying mark or packaging on or relating to the Goods;
- 7.3.3** Maintain the Goods in satisfactory condition and keep them insured against all risks for their full price from the date of delivery;
- 7.3.4** Notify the Company immediately if it becomes subject to any of the events listed in clause 11.1; and
- 7.3.5** Give the Company such information relating to the Goods as the Company may require from time to time.
- 7.4** If before title to the Goods passes to the Customer, the Customer becomes subject to any of the events listed in clause 11.1, then, without limiting any other right or remedy the Company may have:
- 7.4.1** The Customer's right to resell the Goods or use them in the ordinary course of its business ceases immediately; and
- 7.4.2** The Company may at any time require the Customer to deliver up all Goods in its possession that have not been resold, or irrevocably incorporated into another product; and
- 7.4.3** if the Customer fails to do so promptly, enter any premises of the Customer or of any third party where the Goods are stored in order to recover them.

Returns

- 8.1** No Goods delivered to the Customer which are in accordance with the Contract will be accepted by the Company for return without the prior written approval of the Company and at its absolute discretion.
- 8.2** If the Company agrees to accept any such Goods from the Customer for return, the Customer shall be liable to pay a handling charge of 20% of the invoice price. Such Goods must be returned by the Customer (delivery paid) to the Company in their original shipping carton within 30 days.
- 8.3** Goods returned without the prior written approval of the Company or otherwise than in accordance with these Conditions may be returned to the Customer or stored at the Customer's cost without prejudice to any rights or remedies the Customer may have under statute, contract or otherwise.

Price and payment

- 9.1** The price of the Goods shall be the price set out in the Order, or, if no price is quoted, the price of the Goods as set out in the Company's published price list in force as at the date of delivery.
- 9.2** Unless stated in the Order to be a fixed price, the Company upon written notice to the Customer may increase the price at any time before the date of delivery if the cost of materials or labour or overheads relating to the production of the Goods has risen since the date of the Order.
- 9.3** The price for the Goods is exclusive of VAT and all charges in relation to storage, carriage, handling and off-loading. All other taxes, customs duties, duties and expenses shall be the responsibility of the Customer.
- 9.4** The Company may invoice the Customer for the Goods on, or at any time after, the completion of delivery.
- 9.5** The Customer shall pay the invoice in full and in cleared funds in accordance with the trading terms set out in the Order or as otherwise agreed between the Company and the Customer, or if no trading terms are agreed, invoices are payable on the date of the invoice ("Due Date"). Payment shall be made to the bank account nominated in writing by the Company. Time for payment is of the essence.

- 9.6** If the Customer fails to make any payment due to the Company under the Contract by the Due Date for payment, then the Customer shall pay interest on the overdue amount at the rate of 4% per annum above the Bank of England's base rate from time to time. Such interest shall accrue on a daily basis from the Due Date until actual payment of the overdue amount, whether before or after judgment. The Customer shall pay the interest together with the overdue amount.
- 9.7** The Customer shall pay all amounts due under the Contract in full without any set-off, counterclaim, deduction or withholding (except for any deduction or withholding required by law). The Company may at any time, without limiting any other rights or remedies it may have, set off any amount owing to it by the Customer against any amount payable by the Company to the Customer. Where any sums are due to the Company from the Customer, the Company is entitled to suspend all services to the Customer until full payment has been received.
- 9.8** If the Company has to instruct solicitors or other agents to recover money owed by the Customer to the Company then the Customer will indemnify irrevocably, in full and on demand the Company against all fees, expenses and costs payable by the Company to its solicitors or agents.
- 9.9** Where a dispute arises in respect of part only of an invoice, the part(s) of such invoice, which are not be in dispute, shall be paid by the Customer to the Company in accordance with these Conditions.
- 9.10** Credit terms (if any) that are agreed between the Company and the Customer shall govern only the Customer's contractual obligation to make payments to the Company for the price of the Goods.

Goods Supplied on Credit

- 10.1** Goods may only be supplied on credit account terms if an agreement covering such supplies has been offered by the Company and accepted by an authorized representative of the Customer. The Customer must request and complete the credit account application form (the "Application Form") which must be signed by an authorized representative of both parties i.e. Director/Partner, proprietor of a company or in the case of a private individual that person or the person responsible for paying the account. All Goods supplied by the Company to a credit account will be invoiced to the account address by post as soon as possible after the day of sale and will be payable to the Company in accordance with these Conditions as they have been agreed with the account holder. In the case of one or more invoices in which special terms have been agreed in writing, these terms will be referred to on the invoice and payment must be made in accordance with those terms.
- 10.2** Credit accounts must be settled in accordance with the agreed Application Form and these Conditions or any other terms agreed between the parties in writing. Should any monies be outstanding outside the terms agreed between the Company and the account holder, the Company reserves its statutory right to claim interest under the Late Payment of Commercial Debts (Interest) Act 1998.
- 10.3** The Company reserve the right to withdraw credit facilities at any time. Should the Customer fail to pay the whole amount of any sum due under the Contract by the due date, the full balance outstanding on any account between the Company and the Customer shall then become payable immediately and the Company shall further be entitled to cancel the Contract and/or suspend supplies of goods or services under any contract between the Company and the Customer.
- 10.4** The Company shall not be obliged to accept normal stock Goods returned for credit, but may at its absolute discretion do so. All such Goods returned for credit must be accompanied by evidence of original purchase from the Company and the Company shall be entitled at its absolute discretion to impose a 20% handling and/or damage charge in respect of any Goods accepted for return. Goods which are non-stock items and Goods which have been specially ordered will not normally be accepted by way of return for credit. Any Goods which are returned for credit shall not be regarded as having been accepted by the Company until the Company has issued a formal credit note through the channels laid down for such transactions by the Company in writing in respect thereof. The uplifting by the Company's vehicles of Goods for which credit is sought and for which the lorry driver may issue a receipt note is not an acceptance by the Company of liability for credit.

Termination

- 11.1** Without limiting its other rights or remedies, the Company may terminate a Contract (and suspend all future deliveries) with immediate effect by giving written notice to the Customer if:
- 11.1.1** The Customer commits a material breach of any term of the Contract;
 - 11.1.2** The Customer takes any step or action in connection with its entering administration, provisional liquidation or any composition or arrangement with its creditors (other than in relation to a solvent restructuring), being wound up (whether voluntarily or by order of the court, unless for the purpose of a solvent restructuring), having a receiver appointed to any of its assets or ceasing to carry on business or, if the step or action is taken in another jurisdiction, in connection with any analogous procedure in the relevant jurisdiction;
 - 11.1.3** The Customer suspends, threatens to suspend, ceases or threatens to cease to carry on all or a substantial part of its business; or
 - 11.1.4** The Customer's financial position deteriorates to such an extent that in the Company's opinion the Customer's capability to adequately fulfil its obligations under the Contract has been placed in jeopardy.
- 11.2** Without limiting its other rights or remedies, the Company may suspend provision of the Goods under the Contract or any other contract between the Customer and the Company if: (i) the Customer becomes subject to any of the events listed in clause 11.1.1 to clause 11.1.4; or (ii) the Company reasonably believes that the Customer is about to become subject to any of the events listed in clause 11.1.1 to clause 11.1.4; or (iii) if the Customer fails to pay any amount due under any Contract on the due date for payment; or (iv) the Customer fails to accept delivery of any Goods ordered by the Customer in accordance with clause 4; or (v) the Customer commits any other breach under these Conditions.
- 11.3** Without limiting its other rights or remedies, the Company may terminate the Contract with immediate effect by giving written notice to the Customer if the Customer fails to pay any amount due under the Contract (or any other contract between the Customer and the Company) on the due date for payment.
- 11.4** On termination of the Contract for any reason the Customer shall immediately pay to the Company all of the Company's outstanding unpaid invoices and any interest due thereon.
- 11.5** Termination of the Contract shall not affect any of the parties' rights and remedies that have accrued as at termination, including the right to claim damages in respect of any breach of the Contract that existed at or before the date of termination.
- 11.6** Any provision of the Contract that expressly or by implication is intended to come into force or to continue in force on or after termination of the Contract shall remain in full force and effect despite such termination.

Limitation of liability

- 12.1** Nothing in these Conditions shall limit or exclude the Company's liability for:
- 12.1.1** Death or personal injury caused by its negligence, or the negligence of its employees, agents or subcontractors (as applicable);
 - 12.1.2** Fraud or fraudulent misrepresentation;
 - 12.1.3** Breach of the terms implied by section 12 of the Sale of Goods Act 1979;
 - 12.1.4** Defective products under the Consumer Protection Act 1987; or
 - 12.1.5** Any matter in respect of which it would be unlawful for the Company to exclude or restrict liability.

12.2 Subject to clause 12.1:

- 12.2.1** The Company shall under no circumstances whatsoever be liable to the Customer, whether in contract, tort (including negligence), breach of statutory duty, or otherwise, for any loss of profit, loss of business, depletion of goodwill or otherwise (in each case whether direct or indirect) or any indirect or consequential loss (howsoever caused) arising under or in connection with the Contract; and
- 12.2.2** The Company's total liability to the Customer in respect of all other losses arising under or in connection with each Order, whether in contract, tort (including negligence), breach of statutory duty, or otherwise, shall be limited a maximum sum equivalent to the original purchase price of the Order paid by the Customer to the Company under the Contract.

Force Majeure

- 13.1** The Company reserves the right to defer the date of delivery, to cancel the Contract or to reduce the volume of the Goods ordered by the Customer, in each case without liability to the Customer, if the Company is prevented from or delayed in the carrying on of its business due to circumstances beyond the reasonable control of the Company including, without limitation, acts of God, governmental actions, war or national emergency, acts of terrorism, protests, riot, civil commotion, fire, explosion, flood, epidemic, lock-outs, strikes or other labour disputes (whether or not relating to either party's workforce), or restraints or delays affecting carriers or inability or delay in obtaining supplies of adequate or suitable materials provided that, if the event in question continues for a continuous period in excess of 180 days, the Customer shall be entitled to give notice in writing to the Company to terminate the Contract.

General

- 14.1** Assignment and other dealings - The Company may at any time assign, transfer, mortgage, charge, subcontract or deal in any other manner with all or any of its rights or obligations under the Contract.
- 14.2** Assignment and other dealings - The Customer may not assign, transfer, mortgage, charge, subcontract, declare a trust over or deal in any other manner with any or all of its rights or obligations under the Contract without the prior written consent of the Company.

Confidentiality

- 14.3** Each party undertakes that it shall not, at any time during the Contract and for a period of two years after termination of the Contract, disclose to any person any confidential information concerning the business, affairs, customers, clients or companies of the other, except as permitted by this clause 14.3 Each party may disclose the other party's confidential information:
- 14.3.1** To its employees, officers, representatives or advisers who need to know such information for the purposes of exercising the party's rights or carrying out its obligations under or in connection with the Contract. Each party shall ensure that its employees, officers, representatives or advisers to whom it discloses the other party's confidential information comply with clause 14.3 and 14.4; and
- 14.3.2** As may be required by law, a court of competent jurisdiction or any governmental or regulatory authority.
- 14.4** No party shall use any other party's confidential information for any purpose other than to exercise its rights and perform its obligations under or in connection with the Contract.

Data Protection

- 14.5** Any personal information shall be used in accordance with any and all applicable data protection legislation, including the Data Protection Act 1998 (as may be amended or replaced).

Entire Agreement

- 14.6** The Contract constitutes the entire agreement between the parties and supersedes and extinguishes all previous agreements, promises, assurances, warranties, representations and understandings between them, whether written or oral, relating to its subject matter.
- 14.7** Each of the Company and the Customer agrees that it shall have no remedies in respect of any statement, representation, assurance or warranty (whether made innocently or negligently) that is not set out in the Contract. Each of the Company and the Customer agrees that it shall have no claim for innocent or negligent misrepresentation or negligent misstatement based on any statement in the Contract.

14.8 Variation

No variation of the Contract shall be effective unless it is in writing and signed by the parties (or their authorised representatives).

14.9 Waiver

No failure or delay by a party to exercise any right or remedy provided under the Contract or by law shall constitute a waiver of that or any other right or remedy, nor shall it prevent or restrict the further exercise of that or any other right or remedy. No single or partial exercise of such right or remedy shall prevent or restrict the further exercise of that or any other right or remedy.

14.10 Severance

If any provision or part-provision of the Contract is or becomes invalid, illegal or unenforceable, it shall be deemed modified to the minimum extent necessary to make it valid, legal and enforceable. If such modification is not possible, the relevant provision or part-provision shall be deemed deleted. Any modification to or deletion of a provision or part-provision under this clause shall not affect the validity and enforceability of the rest of the Contract.

14.11 Notices

All notices to be served by one party on the other (unless specifically provided for in these Conditions) shall be deemed duly served 7 days after posting if posted by first class or airmail pre-paid to the registered office of the other party or in the absence of such registered office to the address notified in writing between the parties prior to or at the time of the Contract.

14.12 Third Party Rights

The parties to the Contract do not intend that any term of the Contract will be enforceable by virtue of the Contracts (Rights of Third Parties) Act 1999 by any person that is not a party to it.

14.13 Governing Law

The Contract, and any dispute or claim (including non-contractual disputes or claims) arising out of or in connection with it or its subject matter or formation, shall be governed by and construed in accordance with the law of England and Wales.

14.14 Jurisdiction

Each party irrevocably agrees that the courts of England and Wales shall have exclusive jurisdiction to settle any dispute or claim (including non-contractual disputes or claims) arising out of or in connection with the Contract or its subject matter or formation.

Appendix | Product Warranty

O&S Doors Limited ("O&S Doors" or "we" or "us" or "our" or the "Company") is a leading manufacturer and distributor of Kitchen, Bedroom and Bathroom cabinet door frontals and associated accessories to kitchen retailers and manufacturers throughout the UK and Ireland. All of our Goods have been designed to provide you with a quality product that meets your needs. The following paragraphs contain important details concerning your O&S Warranty. You are advised to read these sections carefully so that you are fully aware of the benefits and associated terms. Should you have any questions or queries in relation to the provisions of this O&S Warranty, you should in the first instance, direct such questions to your appointed sales representative or our customer services team.

O&S Doors has implemented a number of industry-leading quality control initiatives and all of our employees are fully committed to delivering quality products that consistently meet independently audited standards and undergo rigorous quality control checks at every stage of the production process. We hold certification from the Forestry Stewardship Council and the Programme for the Endorsement of Forest Certification to ensure that all our timber and raw materials are sourced from ethically managed forests. We are also members of the Furniture Industry Research Association, an independent body set up to ensure the quality and reliability of products used within the furniture industry supply chain. We pride ourselves on the high quality components we produce. However, there are inevitably occasions when defects become apparent following purchase. Initially there may be some snagging issues that require remedial work or items that require adjustment.

Please note that this O&S Warranty Pack is O&S Doors' contractual commitment to you (upon which we intend to rely) in relation to any defects that may arise in relation to the Goods. For the avoidance of doubt this O&S Warranty is personal to you and may not be transferred to any person. Capitalised terms used herein and not otherwise defined shall have the meaning given to them in the O&S Terms and Conditions of Sale.



Warranty Period: 6 Years From Invoiced Date Of Supply.

Important: The warranty period of 6 years for all Replacement and FOC goods commences from the original invoiced date of supply.

If you find you are unsatisfied with the goods that you have received, or you would like to make a Warranty claim please contact us via the relative email address below:

Warranty Claims — warranty@osdoors.com

Replacements / Damaged Goods — aftersales@osdoors.com

O&S Product Warranty: General Terms

- 1.1 The Company warrants that on delivery, and for the relevant Warranty Period (as defined below) the Goods shall:
 - 1.1.1 Conform in all material respects with their description;
 - 1.1.2 Be free from material defects in design, material and workmanship; and
 - 1.1.3 Be of satisfactory quality (in line with the Sale of Goods Act 1979).
- 1.2 The Warranty Periods for each product and class of Goods are specified below (the "Warranty Period"):

Warranty Period: 6 Years From Invoiced Date Of Supply.

Important: The warranty period of 6 years for all Replacement and FOC goods commences from the original invoiced date of supply.

5G Vinyl / Made to Measure

(Including Matt, Superior Matt and High Gloss Finish Doors and Accessories)

5 Piece / Ex.Stock and Made to Measure

(Including Harlem / Fenwick / Dylan / Bastille Doors and Accessories)

Edged / Made to Measure

(Including Phoenix / Tribeca / Vaasa / Mather Doors and Accessories)

Painted / Stock, Painted to Order and Made to Measure

(Including Arena / Hartford / Belair / Wellington / Campbell / Rainey / Edison / Monroe / Albany / Hampton / Greenwich / Hyde Doors and Accessories)

Accessories

(Includes Mouldings / Vinyl Wrapped Accessories / Painted Accessories / Worktops / Panels / Return Gables and Handles)

- 1.3 Subject to exclusions and limitations set out in section 3 below and adherence of the care and maintenance guidelines set out in section 4 below, if:
 - 1.3.1 The Customer gives notice in writing to the Company during the Warranty Period that some or all of the Goods do not comply with the O&S Warranty; and
 - 1.3.2 The Company is given a reasonable opportunity of examining such Goods; and
 - 1.3.3 The Customer returns such Goods to the Company's place of business at the Customer's cost,

The Company shall, at its option, repair or replace the defective Goods, or refund the price of the Goods, that we agree are defective, in full.

- 1.4 Our obligations under this O&S Warranty are limited, at our option, to repairing or replacing any part which proves to be defective or refunding the price if the Goods that we accept are defective. Replacement parts where possible will either be the same or similar and we are under no obligation to replace any part or item with an identical part or item.
- 1.5 Except as provided in this section, the Company shall have no further liability to the Customer in respect of the Goods' failure to comply with the O&S Warranty.
- 1.6 The O&S Warranty for the Warranty Period is the full extent of our obligation to you in relation to the Goods and any other rights and remedies are excluded to the fullest extent of the law.
- 1.7 Any Goods repaired or replaced by the Company (including any repaired or replacement Goods) shall be guaranteed pursuant to this Warranty for the unexpired portion of the relevant Warranty Period that applied to the original Goods supplied. For the avoidance of doubt, the Warranty Period will not be extended by supplying replacement Goods or parts thereof or by repairing such Goods or parts thereof.
- 1.8 The Company reserves the right to charge the Customer for any completed warranty service work where it is found to be caused by negligence, poor commissioning, or any other factor not related to a manufacturing defect, or is otherwise excluded under section 3 below.

Making a Warranty Claim

- 2.1** If you wish to make a claim under the terms of this O&S Warranty then you should contact us immediately after the defect is found or becomes obvious to you.
- 2.2** As stated in section 1.3.1 above you will be required to give notice in writing to the Company during the Warranty Period within a reasonable time of discovery that some or all of the Goods do not comply with the warranty set out in this Warranty Pack. You will provide the Company with:
- 2.2.1** Evidence of the original invoice or proof of purchase (this may include the original invoice number or other evidence of the purchase);
 - 2.2.2** A full description of the defect;
 - 2.2.3** Photographs of the defect; and
 - 2.2.4** The defective part that requires replacement for inspection by either O&S Doors Ltd or a nominee.
- 2.3** On receipt of the above information our customer services department will issue an uplift docket along with a "claim number".
- 2.4** Once a claim is accepted by us (subject to the return of the defective Goods and satisfactory inspection of the same) we will notify you whether we intend to repair, replace or refund the relevant defective Goods. If we notify you that we will refund or replace, we may either (i) refund the value of the Goods where no replacement Goods are issued; (ii) replace the Goods free of charge; or (iii) credit your account where replacement Goods have been issued and charged to your account prior to inspection by us, where it is subsequently agreed by us that the Goods are defective following inspection.
- 2.5** Please be aware the maximum period for return and credit of defective product is limited to one month from the date of supply of the replacement doors.
- 2.6** You must allow us or our agents access to the Goods in order to remedy any defect, where applicable.
- 2.7** Where a claim is rejected we will provide details of why the claim has been rejected.

Any communication with us should ALWAYS be sent in writing or by email and quoting any applicable invoice number to:

Address: O&S Doors Limited, 106 Syerla Road, Benburb, Co. Tyrone, BT71 7ET
Email: warranty@osdoors.com

Exclusions to your Warranty

- 3.1** The O&S Warranty applies to the Goods under normal use, subject to the conditions set out in this Warranty Pack, and as determined by O&S Doors in its sole discretion.
- 3.2** O&S Doors shall not be liable for the Goods' failure to comply with the O&S Warranty and the O&S Warranty does not include the provision of, or the rectification of the Goods in any of the following events:
- 3.2.1** Where the Customer makes any further use of such Goods after giving notice in accordance with section 1.3 above;
 - 3.2.2** The defect arises because the Customer failed to follow O&S Doors' oral or written instructions as to the storage, commissioning, installation, use or the maintenance of the Goods or (if there are none) good trade practice regarding the same;
 - 3.2.3** The defect arises because the Goods have not been used, cared for or maintained in accordance with the care and maintenance instructions as set out in section 4 below;
 - 3.2.4** The defect arises as a result of O&S Doors following any drawing, design or material specification supplied by the Customer;
 - 3.2.5** The Customer alters or repairs such Goods without the prior written consent of O&S Doors;
 - 3.2.6** The defect arises as a result of unfair wear and tear, willful damage, negligence, or abnormal storage or working conditions;
 - 3.2.7** The Goods differ from their description as a result of changes made to ensure they comply with applicable statutory or regulatory requirements;
 - 3.2.8** Any damages to the Goods are attributable to improper installation, inadequate maintenance, improper product use, after market product modifications, normal weathering, highly corrosive environments, damages caused by fire, accident, flood, acts of God, vandalism, building settlement or structure failures, or other circumstances beyond O&S Doors Ltd's control;
 - 3.2.9** The damage to the Goods is caused by or within parts, fixtures or fittings that have not been manufactured or supplied by the Company;
 - 3.2.10** Adjustment of hinges, catches or stays;
 - 3.2.11** Damage caused by the use of unsuitable cleaning materials;
 - 3.2.12** Damage occurring as a result of any alteration, modification, vandalism, or accidental damage to the Goods, misuse, neglect, overloading or abnormal use of your Goods;
 - 3.2.13** Damage caused by the transportation to site or installation of the Goods;
 - 3.2.14** Damage resulting from a failure or delay in arranging for an obvious defect (or any defect which should have been obvious to a reasonable person who has complied with all relevant owner manuals and this O&S Warranty) to be reported under your O&S Warranty or rectified;
 - 3.2.15** Damage caused by repairs attempted or undertaken other than those carried out by us or a third party authorised by us;
 - 3.2.16** Damage as a result of failure to carry out normal day to day maintenance or follow normal maintenance procedures including but not limited to the care and maintenance guidelines in section 4 below;
 - 3.2.17** Damage as a result of toxic, explosive, corrosive or other hazardous materials brought into contact with the Goods;
 - 3.2.18** Damage as a result of exposure to water, excessive moisture or humidity;
 - 3.2.19** Damage as a result of exposure to heat above 60 degrees C;
 - 3.2.20** Damage as a result of flies, insect, bird or rodent infestations;
 - 3.2.21** Damage caused directly or indirectly by war, riot, revolution, act of god or any similar event or by vandalism, theft or attempted theft;
 - 3.2.22** Damage arising from any accident or any act or omission by you;
 - 3.2.23** Where repairs are not authorised by us in writing or carried out by us. We will not take responsibility for any costs associated with or subsequent rectification of any unauthorised repairs;
 - 3.2.24** Where Goods are modified with any parts not supplied by us, or where Goods are incorporated with a modified part; or
 - 3.2.25** Where O&S Doors is NOT the manufacturer of any parts or fixtures and fittings of the Goods, this O&S Warranty does not apply.
- 3.3** We will pay for all parts associated with any repair work carried out under the O&S Warranty up to a maximum sum equivalent to the original purchase price of the Goods. Where multiple claims are made, for whatever reason, our aggregate maximum liability shall also be equivalent to the original purchase price of the Goods. Please see the limitation of liability provisions set out in the O&S Terms and Conditions of Sale.
- 3.4** We cannot accept responsibility for any loss or damage suffered, or incurred as a consequence of your failure or delay in reporting defects promptly.

Installation Care & Maintenance

Installation

- 4.1** Ensure that the relevant rooms have been left to environmentally stabilise prior to the installation of the Goods. Goods must not be installed into a damp moisture rich environment as it will cause undesirable movement in the joints and panels of the Goods. You should ensure that you adequately assess conditions.
- 4.2** To minimise any potential damage during installation we make the following recommendations
- 4.2.1** Prior to installation confirm that you have the correct quantity and size of the Goods.
- 4.2.2** Please make sure that you fully inspect the Goods before drilling or attaching any hinges or other accessories.
- 4.2.3** Take care when unpacking the Goods, for example do not use sharp blades to cut away the packaging.
- 4.2.4** When drilling or attaching the hinges, place the Goods face down on a soft clean surface, ensuring that there is no grit or dust underneath that may cause damage to the surface of the Goods. It is good practice to place a clean barrier between the Goods and the surface when drilling or attaching the hinges.
- 4.2.5** We would recommend that you use a rubber mallet to knock the hinges into the Goods without using excessive force.
- 4.2.6** Once the hinges have been attached we would recommend that you hang the door immediately to avoid any damage. Do not stack the Goods with the hinges touching other Goods as this may mark the Goods.
- 4.2.7** The Goods should be stored flat and away from the working area. Please take care when stacking any Goods with hinges so that they do not mark the other products. Do not lean the Goods against each other or against any surface without proper protection in between the same.
- 4.2.8** Do not stack the Goods on any hard surface as this may cause chipping and scratching along its edge. Prior to fitting, the doors should be stored flat, ensuring that they are not resting on any dirt or debris.
- 4.2.9** Please take extreme care not to put the door down with excessive force on any edge, especially the handle edge as this will cause crushing/impact damage on these edges.
- 4.2.10** Take extreme care not to put the door down on any hard or rough surface such as bare concrete floors, or on any debris such as sawdust, grit or screws, as this can damage the Goods.
- 4.2.11** Where cutting décor panels and trim you must use a sharp quality saw blade of the appropriate grade for finecutting, or a suitable router. Small chips can appear along the cut edge, and so extra care must be taken to minimise the risk of chipping. Using a blunt or inappropriate saw blade will produce a poor finish and this will not be covered by the O&S Warranty.
- 4.2.12** On Painted Products any fine chips along the cut edge should be smoothed with a fine grade sand paper prior to installation.
- 4.2.13** All trims are supplied in long lengths and need to be cut down on site. Please ensure you use the appropriate tools.
- 4.2.14** When fitting the plinth, ensure that you check the dimensions of any adjacent appliances. On occasion, the plinth may need to be pulled forward to ensure that it clears the front of the appliance. This can be achieved by using off cuts to fit blocks the rear of the plinth prior to attaching the plinth clips. This will step the plinth forward from its normal position.

General Care

- 4.3** The most common problems found occur as a result of excessive or prolonged exposure to heat and/or moisture. Always ensure that water is not left around the sink areas as damage caused as a result is not covered by the O&S Warranty.
- 4.4** Always wipe off excess moisture and be careful with extreme heat sources, such as kettles, ovens and toasters. It is recommended that these heat sources are not placed directly under any wall unit when they are in use as they generate a higher level of heat and moisture than is often expected and can quickly and easily lead to damage of the Goods.
- 4.5** Don't place appliances that create steam (e.g. steamers, coffee makers or kettles) underneath the Goods.
- 4.6** If using glass cleaner to clean your glass doors be careful not to damage fine finish of the door and cabinet parts while cleaning. Do not spray glass cleaner directly onto the glass or cabinet as this may discolour the finish or your kitchen cabinets. Instead spray a small amount of the cleaner on a lint free cloth and wipe down the glass.
- 4.7** Don't open the door of the dishwasher immediately once the cycle is finished as the exposure to the heat and humidity may cause the Goods to absorb the moisture and swell.
- 4.8** Please note that after a period of time it is quite normal for the colouring of kitchen units to mellow in colour. This is not a manufacturing fault and is a result of exposure to light. This means that any additional parts subsequently ordered, or supplied as replacements may not be an exact colour match. However, any additional Goods or parts supplied will also mellow over time to blend with your existing units.
- 4.9** The colour of doors and drawer fronts may appear mismatched. This apparent mismatch is sometimes the effect of differing light conditions within your room. To check your Goods you should place them side by side in natural daylight for comparison.

Cleaning Advice for all Door Types

- 4.10** Do not use wax furniture polish, abrasive or aggressive cleaners, bleach or other chlorine based cleaners, multipurpose cleaners, dilutes, acetone, alcohol, solvent or similar products on the Goods, as this will damage the surface. Additionally wax and polishes leave a residue build up that is difficult to remove.
- 4.11** Only use a 1% soap, 99% water (liquid soap) solution, wiping with a damp (not wet) cloth, finally drying with a soft clean cloth only.
- 4.12** Ensure all cooking splashes are wiped immediately with a damp cloth.
- 4.13** Dust the Goods with a soft cloth only.
- 4.14** Never use any abrasive cloths or cleaners on the Goods. Spills and condensation on the Goods should be cleaned and dried immediately.
- 4.15** Our Goods should not be stored or installed in a newly plastered room or damp environment. If you need to store them for a while they should be kept flat, preferably in the room in which they are to be installed. This is of particular importance for tall/wardrobe doors.
- 4.16** Components placed adjacent or below a sink, or covering a dishwasher/washing machine or other water source are exempt from this O&S Warranty, unless the failure can be proven to be other than as a result of moisture penetration.
- 4.17** The Goods are wrapped in a manmade material, as are all similar ones in the kitchen and bedroom industry and should not be exposed to heat in excess of 60 degrees. To avoid damage caused as a result of exposure to excessive heat please follow these simple guidelines:
- 4.17.1** When installing doors adjacent to ovens or other heat sources always ensure doors are shielded by the use of heat deflector strips.
- 4.17.2** Never use an appliance that generates high levels of heat or concentrated steam (such as a toaster, kettle, pressure cooker or bread maker) directly under or adjacent to the Goods as this can cause damage.

- 4.18** Components damaged as a result of not following the above guidelines are not covered by the O&S Warranty unless protected by suitable heat strips and a suitable gap left for heat escape.
- 4.19** The correct care will help ensure that your Goods will look good for a long time.
- 4.20** All high gloss Goods should be allowed to "cure" for seven days after removing the protective film. During this curing process the Goods will be liable to scratching and other marks. Please treat the Goods very carefully during this period and avoid cleaning or wiping as much as possible.
- 4.21** To clean the surface of the Goods, wipe using a soft cloth with a mild nonabrasive, dishwashing detergent diluted in water. The mix should be 1 part detergent to 99 parts water. You should never use any vinegar based detergents, solvents, abrasive detergents, white spirit or furniture polish.
- 4.22** We recommend the use of VuPlex polish with a micro anti-scratch cloth.

Timber & Veneered Doors

- 4.23** It must be remembered that solid timber is a natural living product, therefore it is not possible nor desirable to achieve uniformity of grain or finish within the raw product. Timber will also change colour over time due to exposure to light. It is advised that this is taken into consideration when replacing or fitting new doors some time after the original installation. In addition to cleaning advice already detailed, it is recommended when cleaning timber doors care is taken to clean following the grain direction of the door using only a damp cloth.

Painted Doors

- 4.24** Painted finishes will change colour over time with exposure to light, the rate of change may differ between pieces and therefore is outside the control of O&S Doors Ltd and this O&S Warranty.
- 4.25** As with timber doors, painted product is made from natural products which by their nature are subject to movement depending on the environmental conditions in which they are placed. This natural movement may cause shrinkage or hairline cracks in the paint or along the joints of the Goods. This is considered as part of the features of painted Goods and therefore exempt from this O&S Warranty.
- 4.26** Extreme care should be taken when cleaning painted Goods. In all circumstances use only a damp cloth with a 1% soap, 99% water solution.

Dissatisfied with Parts or Repairs

- 5.1** In the unlikely event that you are dissatisfied with the repair undertaken by us or our agents or are dissatisfied with any parts supplied, you should report your dissatisfaction to us within 14 days of completion of the repair or supply of the part.
- 5.2** If no notice is received within 14 days of completion of the repair or supply of the part, the repair work or part supplied is deemed acceptable to you and the claim is deemed to have been satisfied in full.

Where The O&S Warranty Is Deemed Void

- 6.1** This O&S Warranty is deemed void and of no force or effect in circumstances including, but not limited to: (i) where you have failed to comply with any procedures laid down by us in this O&S Warranty or if you have failed to complete and return within the timescales prescribed any of the forms which we require; (ii) the specification of your Goods have been altered in any material way other than by us; (iii) your Goods have been the subject of an insurance claim to the extent of a write off (or the value of the holiday home/lodge has depreciated by 50% or more); or (iv) you refuse to allow access to the Goods in order to carry out repairs, where required.







Head Office

106 Syerla Road
Benburb
County Tyrone
BT71 7ET
Northern Ireland



+44 (0)28 3754 9190



orders@osdoors.com



osdoors.com

Dublin (Santry)

Unit 9, Boeing Road,
Airways Industrial
Estate, Dublin,
D17 P863

+353 (0) 1852 3002

trade@osdoors.com

Dublin (Clondalkin)

Units F2 / F3, Clondalkin,
Weatherwell Business
Park, Dublin
D22 HN36

+353 (0) 1572 6850

trade@osdoors.com

Manchester

Unit 3a & 3b Castlehill
Industrial Estate, Bredbury,
Industrial Park Stockport
SK62SU

0161511 4317

manchester@osdoors.com

OS Doors[®] **OS** Express